

FLUKE®

5820A

Oscilloscope Calibrator

Operators Manual

PN 802154

April 1999 Rev.3, 11/06

© 1999-2006 Fluke Corporation, All rights reserved. Printed in USA
All product names are trademarks of their respective companies.

LIMITED WARRANTY & LIMITATION OF LIABILITY

Each Fluke product is warranted to be free from defects in material and workmanship under normal use and service. The warranty period is one year and begins on the date of shipment. Parts, product repairs and services are warranted for 90 days. This warranty extends only to the original buyer or end-user customer of a Fluke authorized reseller, and does not apply to fuses, disposable batteries or to any product which, in Fluke's opinion, has been misused, altered, neglected or damaged by accident or abnormal conditions of operation or handling. Fluke warrants that software will operate substantially in accordance with its functional specifications for 90 days and that it has been properly recorded on non-defective media. Fluke does not warrant that software will be error free or operate without interruption.

Fluke authorized resellers shall extend this warranty on new and unused products to end-user customers only but have no authority to extend a greater or different warranty on behalf of Fluke. Warranty support is available if product is purchased through a Fluke authorized sales outlet or Buyer has paid the applicable international price. Fluke reserves the right to invoice Buyer for importation costs of repair/replacement parts when product purchased in one country is submitted for repair in another country.

Fluke's warranty obligation is limited, at Fluke's option, to refund of the purchase price, free of charge repair, or replacement of a defective product which is returned to a Fluke authorized service center within the warranty period.

To obtain warranty service, contact your nearest Fluke authorized service center or send the product, with a description of the difficulty, postage and insurance prepaid (FOB Destination), to the nearest Fluke authorized service center. Fluke assumes no risk for damage in transit. Following warranty repair, the product will be returned to Buyer, transportation prepaid (FOB Destination). If Fluke determines that the failure was caused by misuse, alteration, accident or abnormal condition of operation or handling, Fluke will provide an estimate of repair costs and obtain authorization before commencing the work. Following repair, the product will be returned to the Buyer transportation prepaid and the Buyer will be billed for the repair and return transportation charges (FOB Shipping Point).

THIS WARRANTY IS BUYER'S SOLE AND EXCLUSIVE REMEDY AND IS IN LIEU OF ALL OTHER WARRANTIES, EXPRESS OR IMPLIED, INCLUDING BUT NOT LIMITED TO ANY IMPLIED WARRANTY OF MERCHANTABILITY OR FITNESS FOR A PARTICULAR PURPOSE. FLUKE SHALL NOT BE LIABLE FOR ANY SPECIAL, INDIRECT, INCIDENTAL OR CONSEQUENTIAL DAMAGES OR LOSSES, INCLUDING LOSS OF DATA, WHETHER ARISING FROM BREACH OF WARRANTY OR BASED ON CONTRACT, TORT, RELIANCE OR ANY OTHER THEORY.

Since some countries or states do not allow limitation of the term of an implied warranty, or exclusion or limitation of incidental or consequential damages, the limitations and exclusions of this warranty may not apply to every buyer. If any provision of this Warranty is held invalid or unenforceable by a court of competent jurisdiction, such holding will not affect the validity or enforceability of any other provision.

Fluke Corporation
P.O. Box 9090
Everett, WA 98206-9090
U.S.A.

Fluke Europe B.V.
P.O. Box 1186
5602 BD Eindhoven
The Netherlands

SAFETY TERMS IN THIS MANUAL

This instrument has been designed and tested in accordance with IEC publication 1010-1 (1992-1), Safety Requirements for Electrical Measuring, Control and Laboratory Equipment, and ANSI/ISA-S82.01-1994, and CAN/CSA-C22.2 No. 1010.1-92. This User Manual contains information, warning, and cautions that must be followed to ensure safe operation and to maintain the instrument in a safe condition. Use of this equipment in a manner not specified herein may impair the protection provided by the equipment.

This instrument is designed for IEC 1010-1 Installation Category II use. It is not designed for connection to circuits rated over 4800 VA.

WARNING statements identify conditions or practices that could result in personal injury or loss of life.

CAUTION statements identify conditions or practices that could result in damage to equipment.

SYMBOLS MARKED ON EQUIPMENT



WARNING Risk of electric shock. Refer to the manual (see the Index for references).



GROUND Ground terminal to chassis (earth).



Attention Refer to the manual (see the Index for references). This symbol indicates that information about usage of a feature is contained in the manual.

AC POWER SOURCE

The instrument is intended to operate from an ac power source that will not apply more than 264V ac rms between the supply conductors or between either supply conductor and ground. A protective ground connection by way of the grounding conductor in the power cord is required for safe operation.

USE THE PROPER FUSE

To avoid fire hazard, for fuse replacement use only the specified unit: 100 or 120 V operation, 2 ampere/250 volt time delay; 200 or 240 V operation, 1 ampere/250 volt time delay.

GROUNDING THE INSTRUMENT

The instrument utilizes controlled overvoltage techniques that require the instrument to be grounded whenever normal mode or common mode ac voltages or transient voltages may occur. The enclosure must be grounded through the grounding conductor of the power cord, or through the rear panel ground binding post.

USE THE PROPER POWER CORD

Use only the power cord and connector appropriate for the voltage and plug configuration in your country.

Use only a power cord that is in good condition.

Refer power cord and connector changes to qualified service personnel.

DO NOT OPERATE IN EXPLOSIVE ATMOSPHERES

To avoid explosion, do not operate the instrument in an atmosphere of explosive gas.

DO NOT REMOVE COVER DURING OPERATION

To avoid personal injury or death, do not remove the instrument cover without first removing the power source connected to the rear panel. Do not operate the instrument without the cover properly installed. Normal calibration is accomplished with the cover closed. Access procedures and the warnings for such procedures are contained both in this manual and in the Service Manual. Service procedures are for qualified service personnel only.

DO NOT ATTEMPT TO OPERATE IF PROTECTION MAY BE IMPAIRED

If the instrument appears damaged or operates abnormally, protection may be impaired. Do not attempt to operate the instrument under these conditions. Refer all questions of proper instrument operation to qualified service personnel.

Table of Contents

Chapter	Title	Page
1	Introduction and Specifications.....	1-1
1-1.	Introduction.....	1-3
1-2.	Operation Overview.....	1-4
1-3.	Local Operation.....	1-5
1-4.	Remote Operation (RS-232).....	1-5
1-5.	Remote Operation (IEEE-488).....	1-6
1-6.	Where to Go from Here.....	1-7
1-7.	Instruction Manuals.....	1-7
1-8.	5820A Operators Manual.....	1-7
1-9.	5820A Service Manual.....	1-8
1-10.	Specifications.....	1-8
1-11.	General Specifications.....	1-10
1-12.	Voltage Output Specifications.....	1-11
1-13.	DC Volt Measure Specifications.....	1-11
1-14.	Edge Specifications.....	1-12
1-15.	Leveled Sine Wave Specifications (≤ 600 MHz).....	1-13
1-16.	Time Marker Specifications.....	1-13
1-17.	Wave Generator Specifications.....	1-14
1-18.	1 ns Pulse Generator Specifications.....	1-14
1-19.	Trigger Signal Specifications (Pulse Function).....	1-14
1-20.	Trigger Signal Specifications (Time Marker Function).....	1-15
1-21.	Trigger Signal Specifications (Edge Function).....	1-15
1-22.	Trigger Signal Specifications (Square Wave Voltage Function).....	1-15
1-23.	Trigger Signal Specifications (TV).....	1-15
1-24.	Tunnel Diode Drive Capability.....	1-15
1-25.	Oscilloscope Input Resistance Measurement Specifications.....	1-15
1-26.	Oscilloscope Input Capacitance Measurement Specifications.....	1-15
1-27.	Overload Measurement Specifications.....	1-15
1-28.	External Reference Input Specifications.....	1-16
1-29.	Auxiliary Input/Output Specifications.....	1-16
1-30.	Current Output Specifications.....	1-16
2	Preparing for Operation.....	2-1
2-1.	Introduction.....	2-3

2-2.	Unpacking and Inspection	2-3
2-3.	Replacing The Fuse	2-4
2-4.	Selecting Line Voltage.....	2-4
2-5.	Connecting To Line Power.....	2-5
2-6.	How to Contact Fluke.....	2-7
2-7.	Placement and Rack Mounting.....	2-7
2-8.	Cooling Considerations.....	2-8
3	Feature	3-1
3-1.	Introduction.....	3-3
3-2.	Front Panel Features	3-3
3-3.	Rear Panel Features	3-3
3-4.	Setup Softkey Menu Trees.....	3-10
4	Front Panel Operation.....	4-1
4-1.	Introduction.....	4-3
4-2.	Turning on the Calibrator	4-3
4-3.	Warming up the Calibrator	4-4
4-4.	Using the Softkeys.....	4-4
4-5.	Using the Setup Menu.....	4-4
4-6.	Using the Instrument Setup Menu.....	4-5
4-7.	Utility Functions Menu	4-5
4-8.	Using the Format EEPROM Menu	4-6
4-9.	Resetting the Calibrator	4-7
4-10.	Using the Operate and Standby Modes.....	4-7
4-11.	Connecting the Calibrator to the UUT.....	4-7
4-12.	Starting the Calibrator.....	4-8
4-13.	The Output Signal	4-8
4-14.	Editing and Error Output Settings	4-8
4-15.	Adjusting the Output Signal	4-9
4-16.	Keying in a Value	4-9
4-17.	Adjusting Values with the Rotary Knob	4-10
4-18.	Using $\frac{MULT}{X}$ and $\frac{DIV}{\pm}$	4-11
4-19.	Displaying the Output Error.....	4-11
4-20.	Resetting the Calibrator.....	4-11
4-21.	Calibrating the Voltage Amplitude on an Oscilloscope.....	4-11
4-22.	The VOLTAGE Function.....	4-12
4-23.	The V/DIV Menu	4-13
4-24.	Shortcuts for Setting the Voltage Amplitude	4-13
4-25.	The TRIG (Trigger) Menu.....	4-14
4-26.	Oscilloscope Amplitude Calibration Procedure	4-14
4-27.	Calibrating the Pulse and Frequency Response on an Oscilloscope....	4-15
4-28.	The Edge Function	4-15
4-29.	The TRIG (Trigger) Menu.....	4-16
4-30.	Oscilloscope Pulse Response Calibration Procedure	4-17
4-31.	Pulse Response Calibration Using a Tunnel Diode Pulser.....	4-18
4-32.	The Leveled Sine Wave Function	4-19
4-33.	Shortcuts for Setting the Frequency and Voltage.....	4-21
4-34.	The MORE OPTIONS Menu	4-21
4-35.	Sweeping Through a Frequency Range.....	4-22
4-36.	Oscilloscope Frequency Response Calibration Procedure	4-23
4-37.	Calibrating the Time Base of an Oscilloscope.....	4-24
4-38.	The Time Marker.....	4-25
4-39.	The TRIG (Trigger) Menu.....	4-26

4-40.	Time Base Marker Calibration Procedure for an Oscilloscope	4-26
4-41.	Testing the Trigger.....	4-27
4-42.	Testing Video Triggers	4-29
4-43.	Verifying Pulse Capture.....	4-30
4-44.	The TRIG (Trigger) Menu.....	4-31
4-45.	Measuring the DC Calibration Output of an Oscilloscope	4-32
4-46.	Measuring Input Impedance and Capacitance	4-32
4-47.	Input Impedance Measurement	4-33
4-48.	Input Capacitance Measurement	4-33
4-49.	Testing Overload Protection	4-34
4-50.	Using Auxiliary Input (AUXIN).....	4-35
4-51.	Setting the Output Channel.....	4-36
4-52.	Using an External Reference	4-36
4-53.	Using the Current Output Function	4-36
5	Remote Operation	5-1
5-1.	Introduction.....	5-4
5-2.	Setting up the IEEE-488 Port for Remote Control	5-4
5-3.	IEEE-488 Port Setup Procedure	5-7
5-4.	Testing the IEEE-488 Port.....	5-8
5-5.	Setting up the RS-232 Host Port for Remote Control.....	5-11
5-6.	RS-232 Host Port Setup Procedure	5-11
5-7.	Testing the RS-232 Host Port.....	5-13
5-8.	Testing RS-232 Host Port Operation using a Terminal	5-13
5-9.	Testing RS-232 Host Port Operation using Visual Basic	5-15
5-10.	Setting up the RS-232 UUT Port for Remote Control.....	5-16
5-11.	RS-232 UUT Port Setup Procedure.....	5-16
5-12.	Testing the RS-232 UUT Port via RS-232 Host Port.....	5-17
5-13.	Testing RS-232 UUT Port Operation via a Terminal.....	5-19
5-14.	Testing RS-232 UUT Port Operation using Visual Basic.....	5-20
5-15.	Testing the RS-232 UUT Port via IEEE-488 Port.....	5-21
5-16.	Changing between Remote and Local Operation	5-23
5-17.	Local State.....	5-23
5-18.	Local with Lockout State.....	5-23
5-19.	Remote State.....	5-23
5-20.	Remote with Lockout State	5-23
5-21.	RS-232 Interface Overview	5-24
5-22.	IEEE-488 Interface Overview.....	5-25
5-23.	Using Commands.....	5-26
5-24.	Types of Commands.....	5-28
5-25.	Device-Dependent Commands.....	5-28
5-26.	Common Commands.....	5-28
5-27.	Query Commands.....	5-28
5-28.	Interface Messages (IEEE-488)	5-28
5-29.	Compound Commands.....	5-30
5-30.	Coupled Commands	5-30
5-31.	Overlapped Commands.....	5-31
5-32.	Sequential Commands.....	5-31
5-33.	Commands that Require the Calibration Switch to be Enabled ...	5-31
5-34.	Commands for RS-232 Only.....	5-31
5-35.	Commands for IEEE-488 Only.....	5-32
5-36.	Command Syntax	5-33
5-37.	Parameter Syntax Rules	5-33
5-38.	Extra Space or Tab Characters.....	5-34

5-39.	Terminators	5-35
5-40.	Incoming Character Processing.....	5-35
5-41.	Response Message Syntax	5-36
5-42.	Checking 5820A Status	5-37
5-43.	Serial Poll Status Byte (STB).....	5-37
5-44.	Service Request (SRQ) Line	5-39
5-45.	Service Request Enable Register (SRE).....	5-39
5-46.	Programming the STB and SRE	5-40
5-47.	Event Status Register (ESR).....	5-40
5-48.	Event Status Enable (ESE) Register	5-40
5-49.	Bit Assignments for the ESR and ESE.....	5-40
5-50.	Programming the ESR and ESE.....	5-41
5-51.	Instrument Status Register (ISR).....	5-42
5-52.	Instrument Status Change Registers.....	5-42
5-53.	Instrument Status Change Enable Registers.....	5-42
5-54.	Bit Assignments for the ISR, ISCR, and ISCE	5-42
5-55.	Programming the ISR, ISCR, and ISCE	5-44
5-56.	Output Queue	5-44
5-57.	Error Queue	5-45
5-58.	Remote Program Examples.....	5-45
5-59.	Guidelines for Programming the Calibrator	5-45
5-60.	Writing an SRQ and Error Handler	5-46
5-61.	Using *OPC?, *OPC, and *WAI	5-47
5-62.	Taking an Impedance Measurement.....	5-47
5-63.	Using the RS-232 UUT Port to Control an instrument	5-48
5-64.	Input Buffer Operation	5-48
6	Remote Codes	6-1
6-1.	Introduction.....	6-3
6-2.	Command Summary by Function	6-3
6-3.	Summary of Commands and Queries	6-8
7	Maintenance.....	7-1
7-1.	Introduction.....	7-3
7-2.	Replacing the Line Fuse	7-3
7-3.	Cleaning the Air Filter	7-4
7-4.	General Cleaning	7-6
7-5.	Verification Tables	7-6
7-6.	DC Voltage Output Verification	7-6
7-7.	AC Voltage Amplitude Verification.....	7-7
7-8.	AC Voltage Frequency Verification.....	7-8
7-9.	DC Voltage Measurement Verification.....	7-8
7-10.	Wave Generator Amplitude Verification: 1 M Ω Output Impedance	7-9
7-11.	Wave Generator Amplitude Verification: 50 Ω Output Impedance.....	7-10
7-12.	Wave Generator Frequency Verification: 1 M Ω Output Impedance	7-11
7-13.	Leveled Sinewave Verification: Amplitude	7-11
7-14.	Leveled Sinewave Verification: Frequency	7-11
7-15.	Leveled Sinewave Verification: Harmonics.....	7-12
7-16.	Leveled Sinewave Verification: Flatness	7-13
7-17.	Edge Verification: Amplitude	7-19
7-18.	Edge Verification: Frequency.....	7-19
7-19.	Edge Verification: Duty Cycle	7-19
7-20.	Edge Verification: Rise Time	7-20
7-21.	Tunnel Diode Pulser Verification.....	7-20

7-22.	Marker Generator Verification	7-20
7-23.	Pulse Generator Verification: Period.....	7-21
7-24.	Pulse Generator Verification: Pulse Width	7-21
7-25.	Input Impedance Verification: Resistance.....	7-21
7-26.	Input Impedance Verification: Capacitance	7-21
7-27.	Current Verification.....	7-22
8	Options.....	8-1
8-1.	Introduction.....	8-3
8-2.	5820A-5 Option	8-3
8-3.	GHz Option.....	8-3
8-4.	Using the GHz Option Functions	8-3
8-5.	Fast Edge Specifications.....	8-4
8-6.	Leveled Sine Wave (> 600 MHz) Specifications	8-5
8-7.	Time Marker Specifications	8-6
8-8.	GHz Option Verification Tables.....	8-7
8-9.	Extended Leveled Sinewave Verification: Flatness	8-7
8-10.	Leveled Sinewave Verification: Harmonics.....	8-15
9	Accessories	9-1
9-1.	Introduction.....	9-3
9-2.	Rack Mount Kit	9-3
9-3.	IEEE-488 Interface Cables	9-4
9-4.	RS-232 Null-Modem Cables	9-4
9-5.	RS-232 Modem Cables.....	9-4
Appendices		
A	Glossary.....	A-1
B	ASCII and IEEE-488 Bus Codes.....	B-1
C	IEEE-488 Interface Card.....	C-1
D	RS-232/IEEE-488 Cables and Connectors.....	D-1
E	Creating a Visual Basic Test Program.....	E-1
F	Error Message	F-1

Index

List of Tables

Table	Title	Page
2-1.	Standard Equipment	2-3
2-2.	Line Power Cord Types Available from Fluke	2-7
3-1.	Front Panel Features	3-4
3-2.	Rear Panel Features	3-9
3-3.	Factory Default Settings for the SETUP Menus	3-19
4-1.	Factory Defaults for SETUP	4-6
4-2.	Keys That Exit Error Mode	4-9
5-1.	Operating State Transitions	5-24
5-2.	RS-232 Interface Wiring	5-24
5-3.	RS-232 Emulation of IEEE-488 Messages	5-25
5-4.	IEEE-488 Remote Message Coding	5-27
5-5.	IEEE-488 Interface Messages (Receive)	5-29
5-6.	Interface Messages (Send)	5-30
5-7.	Commands for RS-232 Only	5-32
5-8.	Commands for IEEE-488 Only	5-32
5-9.	Units Accepted in Parameters and Used in Responses	5-33
5-10.	Terminator Characters	5-35
5-11.	Response Data Types	5-36
5-12.	Status Register Summary	5-37
6-1.	Command Summary by Function	6-3
6-2.	SCOPE Command Parameters	6-32
7-1.	Replacement Fuses	7-3
7-2.	DC Voltage Output Verification	7-6
7-3.	AC Voltage Amplitude Verification	7-7
7-4.	AC Voltage Frequency Verification	7-8
7-5.	DC Voltage Measurement Verification	7-8
7-6.	Wave Generator Amplitude Verification (into 1 M Ω output impedance)	7-9
7-7.	Wave Generator Amplitude Verification (into 50 Ω impedance)	7-10
7-8.	Wave Generator Frequency Verification (into 1 M Ω Impedance)	7-11
7-9.	Leveled Sinewave Verification: Amplitude	7-11
7-10.	Leveled Sinewave Verification: Frequency	7-11
7-11.	Leveled Sinewave Verification: Harmonics	7-12
7-12.	Leveled Sinewave Verification: Flatness	7-13
7-13.	Edge Verification: Amplitude	7-19
7-14.	Edge Verification: Frequency	7-19

7-15. Edge Verification: Duty Cycle.....	7-19
7-16. Edge Verification: Rise Time.....	7-20
7-17. Tunnel Diode Pulser Verification	7-20
7-18. Marker Generator Verification.....	7-20
7-19. Pulse Generator Verification: Period	7-21
7-20. Pulse Generator Verification: Pulse Width	7-21
7-21. Input Impedance Verification: Resistance	7-21
7-22. Input Impedance Verification: Capacitance	7-21
7-23. DC Current Verification.....	7-22
7-24. AC Current Verification.....	7-22
8-1. Fast Edge Specifications	8-4
8-2. Leveled Sine Wave Specifications (> 600 MHz).....	8-5
8-3. Time Marker Specifications	8-6
8-4. Leveled Sinewave Verification: Flatness.....	8-7
8-5. Leveled Sinewave Verification: Harmonics.....	8-15
9-1. Options and Accessories	9-3
D-1. IEEE-488 Connection Cables.....	D-1
D-2. Serial Port Connection Cables.....	D-2
F-1. Error Message Format.....	F-1

List of Figures

Figure	Title	Page
1-1.	5820A Multi-Product Calibrator	1-4
1-2.	RS-232 Remote Connections	1-6
1-3.	5820A Calibrator Dimensional Outline	1-9
2-1.	Accessing the Fuse and Selecting Line Voltage	2-6
2-2.	Line Power Cord Types Available from Fluke	2-7
3-1.	Front Panel View.....	3-4
3-2.	Rear Panel View.....	3-9
3-3.	SETUP Softkey Menu Tree	3-10
3-4.	SETUP Softkey Menu Displays	3-11
3-4.	SETUP Softkey Menu Displays	3-12
4-1.	Oscilloscope connection: channel and External Trigger	4-7
4-2.	Tunnel Diode Pulser Connections.....	4-19
5-1.	Typical IEEE-488 Remote Control Connections	5-5
5-2.	Typical RS-232 Remote Control Connections.....	5-6
5-3.	Testing the IEEE-488 Port	5-8
5-4.	Testing the RS-232 Host Port	5-13
5-5.	Testing the RS-232 UUT Port via the RS-232 Host Port.....	5-18
5-6.	Testing the RS-232 UUT Port via IEEE-488 Port	5-21
5-7.	Status Register Overview	5-38
5-8.	Serial Poll Status Byte (STB) and Service Request Enable (SRE)	5-39
5-9.	Event Status Register (ESR) and Event Status Enable (ESE).....	5-41
5-10.	Bit Assignments for the ISR, ISCEs and ISCRs	5-43
7-1.	Accessing the Fuse	7-4
7-2.	Accessing the Air Filter.....	7-5
D-1.	IEEE-488 Connector Pinout (connection side)	D-1
D-2.	SERIAL 1 FROM HOST Port Connector Pinout	D-2
D-3.	SERIAL 2 TO UUT Port Connector Pinout (connection side).....	D-2
D-4.	Serial Port Connections (DB-9/DB-9)	D-3
D-5.	Serial Port Connections (DB-9/DB-25)	D-4

Chapter 1

Introduction and Specifications

	Title	Page
1-1.	Introduction.....	1-3
1-2.	Operation Overview.....	1-4
1-3.	Local Operation.....	1-5
1-4.	Remote Operation (RS-232).....	1-5
1-5.	Remote Operation (IEEE-488).....	1-6
1-6.	Where to Go from Here	1-7
1-7.	Instruction Manuals	1-7
1-8.	5820A Operators Manual	1-7
1-9.	5820A Service Manual	1-8
1-10.	Specifications.....	1-8
1-11.	General Specifications.....	1-10
1-12.	Voltage Output Specifications.....	1-11
1-13.	DC Volt Measure Specifications	1-11
1-14.	Edge Specifications	1-12
1-15.	Leveled Sine Wave Specifications (≤ 600 MHz)	1-13
1-16.	Time Marker Specifications	1-13
1-17.	Wave Generator Specifications	1-14
1-18.	1 ns Pulse Generator Specifications	1-14
1-19.	Trigger Signal Specifications (Pulse Function).....	1-14
1-20.	Trigger Signal Specifications (Time Marker Function)	1-15
1-21.	Trigger Signal Specifications (Edge Function)	1-15
1-22.	Trigger Signal Specifications (Square Wave Voltage Function)	1-15
1-23.	Trigger Signal Specifications (TV)	1-15
1-24.	Tunnel Diode Drive Capability	1-15
1-25.	Oscilloscope Input Resistance Measurement Specifications.....	1-15
1-26.	Oscilloscope Input Capacitance Measurement Specifications	1-15
1-27.	Overload Measurement Specifications	1-15
1-28.	External Reference Input Specifications	1-16
1-29.	Auxiliary Input/Output Specifications.....	1-16
1-30.	Current Output Specifications	1-16

1-1. Introduction

The Fluke Model 5820A Oscilloscope Calibrator (Figure 1-1) is a precise instrument that calibrates analog and digital oscilloscopes. Specifications are provided in this chapter.

Warning

To prevent electric shock or other possible injuries, the 5820A Calibrator must be operated in the way specified by this manual or other documentation provided by Fluke.

Caution

Input voltages exceeding 30 VDC may cause damage to the instrument. Do not apply voltages except in voltage measurement mode.

Features of the 5820A Calibrator include the following:

- Automatic meter error calculation.
-  and  keys that change the output value to pre-determined cardinal values for various functions.
- Programmable entry limits that prevent invalid amounts from being entered.
- Edge, Leveled Sine, Pulse, Marker, and Wave Generation modes.
- Accurate oscilloscopic input impedance measurement.
- Tunnel Diode Pulse compatibility.
- DC Volt Measure Mode.
- Current Mode generates both DC and low frequency AC current.
- 1 ns to 500 ns pulse width capability with skew controlled trigger.

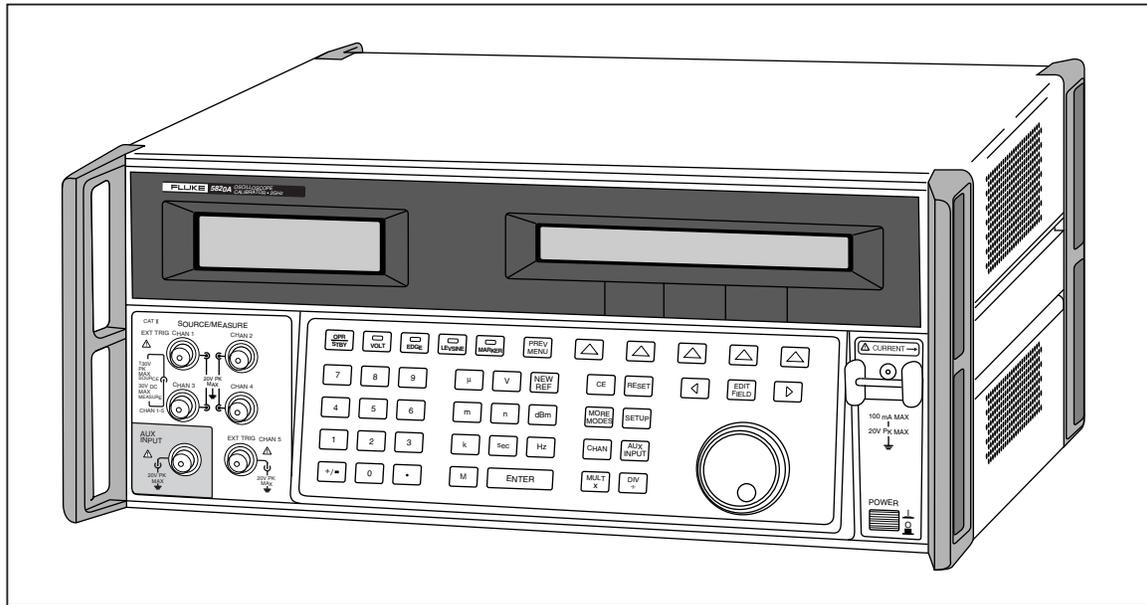

Figure 1-1. 5820A Oscilloscope Calibrator

yh001f.eps

- External reference.
- Auxiliary input.
- 5-channel output (5-channel option). The 5-channel option allows you to calibrate up to five oscilloscope channels simultaneously without changing cables.
- Simultaneous output of a signal and a trigger signal.
- 600 MHz, Leveled Sine wave output.
- Optional 600 MHz - 2.1 GHz, Leveled Sine wave output with 150 ps fast edge.
- Standard IEEE-488 (GPIB) interface, complying with ANSI/IEEE Standards 488.1-1987 and 488.2-1987.
- EIA Standard RS-232-C serial data interface for printing, displaying, or transferring internally stored calibration constants, and for remote control of the 5820A.
- Pass-through RS-232-C serial data interface for communicating with the Unit Under Test (UUT).
- Extensive automatic internal self testing and diagnostics of analog and digital functions.

1-2. Operation Overview

The 5820A Calibrator may be operated at the front panel in the local mode, or remotely using RS-232 or IEEE-488 ports. For remote operations, several software options are available to integrate 5820A operation into a wide variety of calibration requirements.

1-3. Local Operation

Typical local operations include front panel connections to the Unit Under Test (UUT), and then manual keystroke entries at the front panel to place the calibrator in the desired output mode. The front panel layout facilitates hand movements from left to right, and multiply and divide keys make it easy to step up or down at the press of a single key. The backlit liquid crystal display is easy to read from many different viewing angles and lighting conditions, and the large, easy-to-read keys are color-coded and provide tactile feedback when they are pressed.

1-4. Remote Operation (RS-232)

The Calibrator has two rear-panel serial data RS-232 ports: SERIAL 1 FROM HOST, and SERIAL 2 TO UUT (Figure 1-2). Each port is dedicated to serial data communications for operating and controlling the 5820A during calibration procedures. For complete information on remote operations, see Chapter 5 of the 5820A Operators Manual.

The SERIAL 1 FROM HOST serial data port connects a host terminal or personal computer to the 5820A. You have several choices for sending commands to the 5820A: you can enter commands from a terminal (for example, using the Terminal accessory from Windows using a PC), you can write your own programs using BASIC, or you can run optional Windows-based software such as 5500/CAL or MET/CAL. The 5500/CAL software includes more than 200 example procedures covering a wide range of test tools the 5820A can calibrate. (See Chapter 6 for a discussion of the RS-232 commands.)

The SERIAL 2 TO UUT serial data port connects a UUT to a PC or terminal via the 5820A (see Figure 1-2). This “pass-through” configuration eliminates the requirement for two COM ports at the PC or Terminal. A set of four commands control the operation of the SERIAL 2 TO UUT serial port. See Chapter 6 for a discussion of the UUT commands.

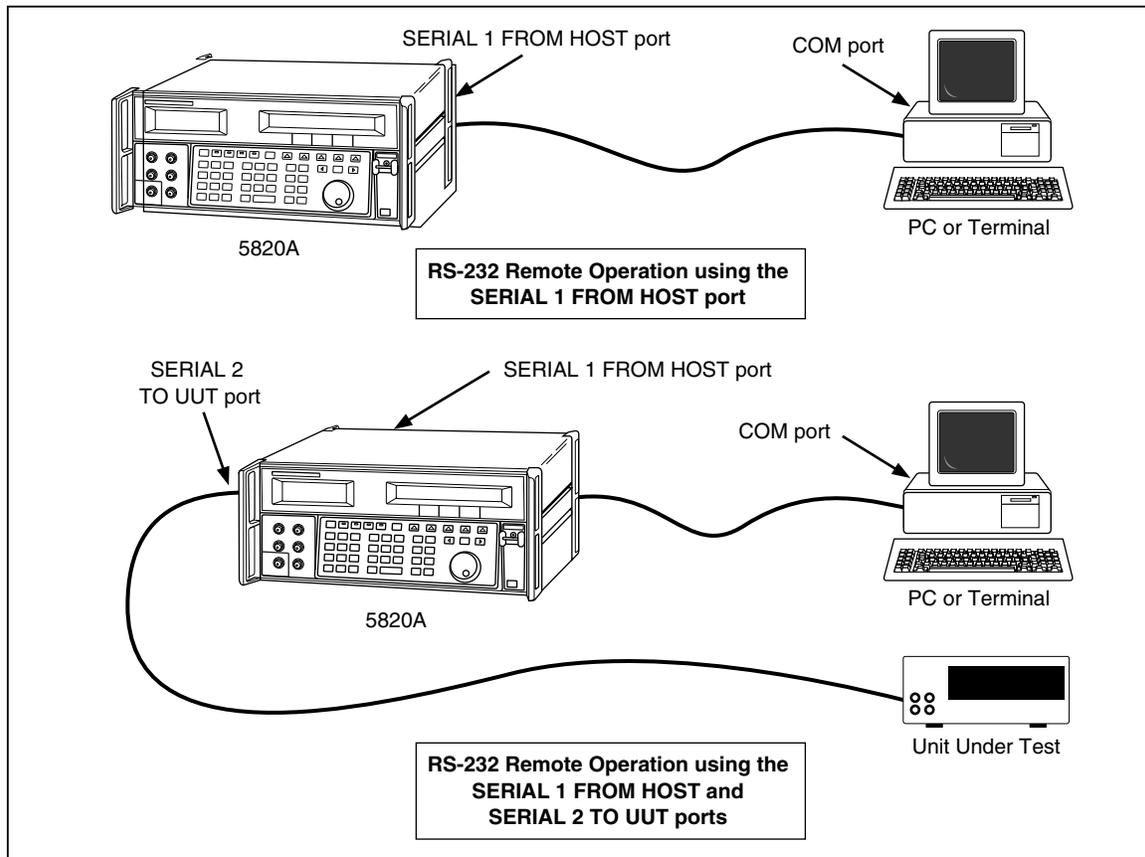

yh002f.eps

Figure 1-2. RS-232 Remote Connections

1-5. Remote Operation (IEEE-488)

The 5820A rear panel IEEE-488 port is a fully programmable parallel interface bus meeting standard IEEE-488.1 and supplemental standard IEEE-488.2. Under the remote control of an instrument controller, the 5820A Calibrator operates exclusively as a “talker/listener.” You can write your own programs using the IEEE-488 command set or run the optional Windows-based MET/CAL software. (See Chapter 6 for a discussion of the commands available for IEEE-488 operation.)

1-6. Where to Go from Here

To locate specific information concerning the installation and operation of the 5820A calibrator, refer to the following list.

- Unpacking and setup: see Chapter 2
- Installation and rack mounting: see Chapter 2 and the rack mount kit instruction sheet
- AC line power and interface cabling: see Chapter 2
- Controls, indicators, and displays: see Chapter 3
- Front panel operation: see Chapter 4
- Cabling to a UUT (Unit Under Test): see Chapter 4
- Using the auxiliary amplifier: see Chapter 4
- Remote operation (IEEE-488 or serial): see Chapter 5
- Accessories to the 5820A Calibrator: see Chapter 9
- Instrument specifications: see Chapter 1

1-7. Instruction Manuals

The 5820A Manual Set provides complete information for operators and service or maintenance technicians. The set includes:

- *5820A Operators Manual* (PN 802154)
- *5820A Service Manual* (PN 673142)

The *5820A Operators Manual* ships with the instrument. The *5820A Service Manual* is optional. Order additional copies of the manuals separately using the part number provided. For ordering instructions, refer to the Fluke Catalog, or ask a Fluke sales representative (see Chapter 2 for more information).

1-8. 5820A Operators Manual

The *5820A Operators Manual* provides complete information for installing the 5820A Oscilloscope Calibrator and operating it from the front panel keys and in remote configurations. This manual also provides a glossary of calibration, specifications, and error code information. The *5820A Operators Manual* includes the following topics:

- Installation
- Operating controls and features, including front panel operation
- Remote operation (IEEE-488 bus or serial port remote control)

- Serial port operation (printing, displaying, or transferring data, and setting up for serial port remote control)
- Operator maintenance, including verification procedures and calibration approach for the 5820A
- Accessories
- Error Messages

1-9. 5820A Service Manual

The *5820A Service Manual* can be ordered through your local Fluke Sales or Service representative (see Chapter 2 for more information). The *5820A Service Manual* includes: appropriate theory of operation, performance testing, maintenance, calibration and verification procedures, and specifications.

1-10. Specifications

The following paragraphs describe the details for the 5820A specifications. All specifications are valid after allowing a warm-up period of 30 minutes, or twice the time the 5820A has been turned off. (For example, if the 5820A has been turned off for 5 minutes, the warm-up period is 10 minutes.)

All specifications apply for the temperature and time period indicated. For temperatures outside of $t_{cal} \pm 5\text{ }^{\circ}\text{C}$ (t_{cal} is the ambient temperature when the 5820A was calibrated), the temperature coefficient is less than 0.1 times the 1-year specification per $^{\circ}\text{C}$ (limited to $0\text{ }^{\circ}\text{C} - 50\text{ }^{\circ}\text{C}$).

If you ordered the GHz Option, the following specification tables are supplemented by the tables with similar headings in Chapter 8.

- Edge Specifications
- Leveled Sine Wave Specifications

Refer to Figure 1-3 for the dimensional outline of the 5820A Calibrator.

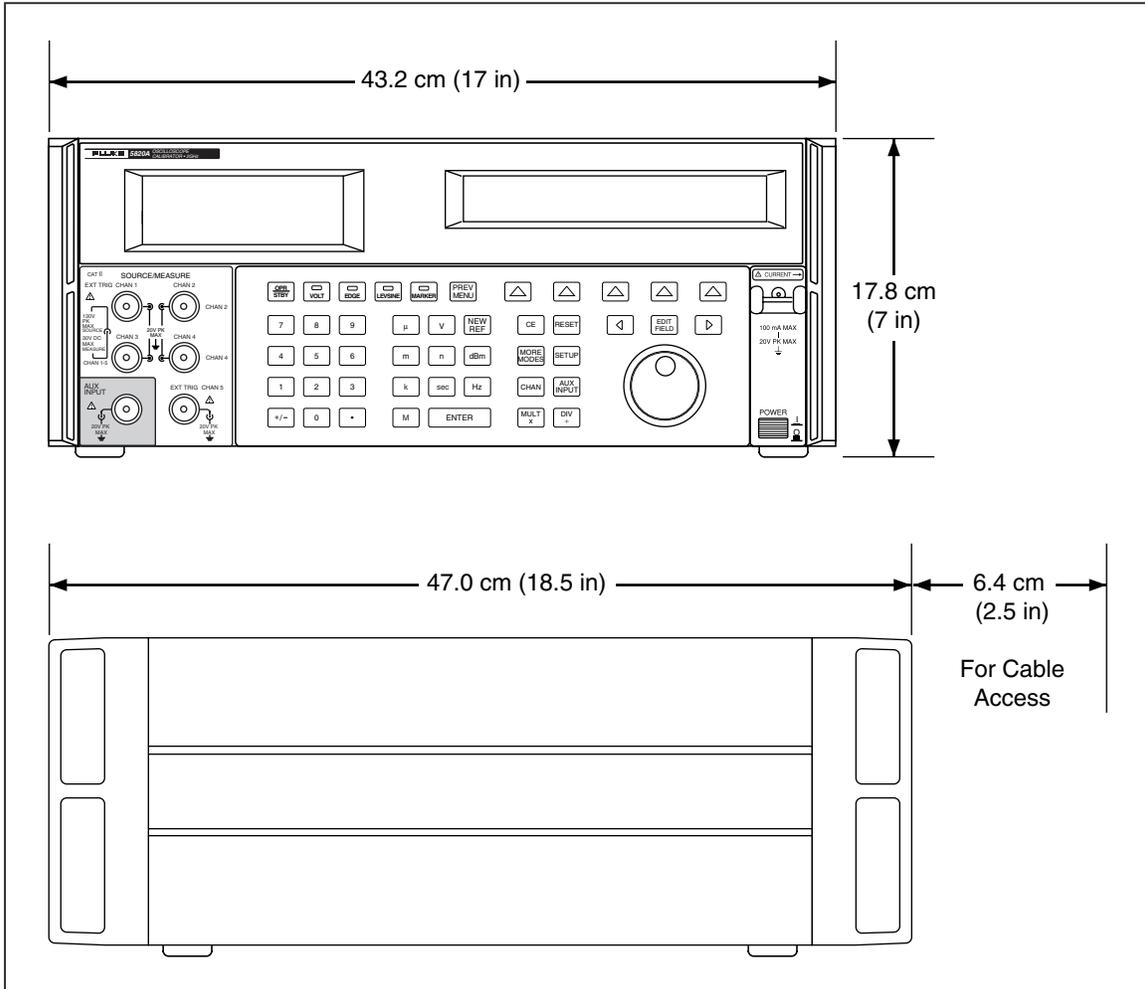

Figure 1-3. 5820A Calibrator Dimensional Outline

yh003f.eps

1-11. General Specifications

Warmup Time	Twice the time since last warmed up, to a maximum of 30 minutes
Settling Time	5 seconds or faster for all functions and ranges
Standard Interfaces	IEEE-488 (GPIB), RS-232
Temperature Performance	Operating: 0 °C to 50 °C
	Calibration (tcal): 15 °C to 35 °C
	Storage: -20 °C to 70 °C
Electromagnetic Compatibility	Designed to operate in Standard Laboratory environments where the Electromagnetic environment is highly controlled. If used in areas with Electromagnetic fields >1 V/m, there could be errors in output values. From 80 – 252 MHz, the current output is susceptible to a field strength of > 0.165 V/M.
Temperature Coefficient	Temperature Coefficient for temperatures outside tcal ± 5 °C is 0.1X/°C of 1-year specification.
Relative Humidity^[1]	Operating: < 80 % to 30 °C, < 70 % to 40 °C, < 40 % to 50 °C
	Storage: < 95 %, noncondensing
Altitude	Operating: 3,050 m (10,000 ft) maximum
	Nonoperating: 12,200 m (40,000 ft) maximum
Safety	Designed to comply with IEC 1010-1 (1992-1); ANSI/ISA-S82.01-1994; CAN/CSA-C22.2 No. 1010.1-92
Output Impedance	The 5820A is designed to drive both 50 Ω and 1 M Ω loads
Analog Low Isolation	20 V
EMC	Complies with EN 61326-1
Line Power	Line Voltage (selectable): 100 V, 120 V, 220 V, 240 V
	Line Frequency: 47 to 63 Hz
	Line Voltage Variation: ± 10 % about line voltage setting
Power Consumption	250 VA
Dimensions	Height: 17.8 cm (7 inches), standard rack increment, plus 1.5 cm (0.6 inch) for feet on bottom of unit.
	Width: 43.2 cm (17 inches), standard rack width
	Depth: 47.3 cm (18.6 inches) overall
Weight	20 kg (44 pounds)
Absolute Uncertainty Definition	The 5820A specifications include stability, temperature coefficient, linearity, line and load regulation, and the traceability of the external standards used for calibration. You do not need to add anything to determine the total specification of the 5820A for the temperature range indicated.
Specification Confidence Interval	99 %
[1] After long periods of storage at high humidity, a drying out period (with the power on) of at least one week may be required.	

1-12. Voltage Output Specifications

Volt Function	DC Signal		Square Wave Signal ^[1]	
Load	into 50 Ω	into 1 MΩ	into 50 Ω	into 1 MΩ
Amplitude Characteristics				
Range	0 V to ±6.6 V	0 V to ±130 V	±1 mV to ±6.6 V p-p	±1 mV to ±130 V p-p
	Resolution			
1 mV to 24.999 mV	1 μV			
25 mV to 109.99 mV	10 μV			
110 mV to 2.1999 V	100 μV			
2.2 V to 10.999 V	1 mV			
11 V to 130 V	10 mV			
Adjustment Range	Continuous			
1-Year Absolute Uncertainty, tcal ±5 °C	±0.25 % of output +40 μV)	±0.025 % of output +25 μV)	±0.25 % of output +40 μV)	±0.05 % of output +5 μV) ^[2]
Sequence	1-2-5 (e.g., 10 mV, 20 mV, 50 mV)			
Square Wave Frequency Characteristics				
Range	10 Hz to 10 kHz			
1-Year Absolute Uncertainty, tcal ±5 °C	±(0.33 ppm of setting)			
Typical Aberration (from 50 % of leading/trailing edge)	< (0.5 % of output + 100 μV)			
25 mV to 130 V: within 4 μs				
10 mV to 25 mV: within 8 μs				
1 mV to 10 mV: within 14 μs				
[1] Positive or negative, zero referenced square wave.				
[2] Above 1 kHz, ±(0.25 % of output + 40 μV). Assumes connectors and cables are in good condition.				

1-13. DC Volt Measure Specifications

⚠ Caution

Input voltages exceeding 30 VDC may cause damage to the instrument.

Voltage Range	Voltage Accuracy
DCV ±10 V maximum with 1 mV resolution	0 to ±5.99 V - 0.05 % ±1 mV
	6 to ±10 V - 0.25 % ±10 mV
	>1 MΩ input impedance (measure voltage across 1 MΩ input resistor)

1-14. Edge Specifications

Note

The GHz Option offers a Fast Edge function. The specifications for the Fast Edge function can be found in Chapter 8 of the 5820A Operators Manual.

Edge Characteristics into 50 Ω load		1 Year Absolute Uncertainty, tcal ± 5 $^{\circ}$ C
Rise Time	≤ 300 ps	$\pm 0/- 100$ ps
Amplitude Range (p-p)	4.0 mV to 2.5 V	$\pm (2\%$ of output + 200 μ V)
Resolution	4 digits	
Adjustment Range	$\pm 10\%$ around each sequence value (indicated below)	
Sequence Values	5 mV, 10 mV, 25 mV, 50 mV, 60 mV, 80 mV, 100 mV, 200 mV, 250 mV, 300 mV, 500 mV, 600 mV, 1 V, 2.5 V	
Frequency Range	1 kHz to 10 MHz	$\pm (0.33$ ppm of setting)
Typical Jitter, edge to trigger	< 3 ps (p-p)	
Leading Edge Aberrations ^[2]	within 2 ns from 50 % of rising edge	< (3 % of output + 2 mV)
	2 to 5 ns	< (2 % of output + 2 mV)
	5 to 30 ns	< (1 % of output + 2 mV)
	after 30 ns	< (0.5 % of output + 2 mV)
Typical Duty Cycle	45 % to 55 %	
<p>[1] Frequency range above 2 MHz has rise time specification 350 ps typical.</p> <p>[2] The leading edge aberrations below 250 mV are typical. All readings are referenced to a Tek11801 with an SD26 module or a Tek820 oscilloscope with an 8-GHz bandwidth option.</p>		

1-15. Leveled Sine Wave Specifications (≤ 600 MHz)

Note

The GHz Option offers an extended 600 MHz to 2.1 GHz Leveled Sine Wave range. If the GHz Option is installed, see the Leveled Sine Wave Specifications (> 600 MHz) table in Chapter 8 of the 5820A Operators Manual.

Leveled Sine Wave Characteristics into 50 Ω	Frequency Range				
	50 KHz (reference)	50 KHz to 100 MHz	100 MHz to 300 MHz	300 MHz to 500 MHz	500 MHz to 600 MHz
Amplitude Characteristics					
Range (p-p)	5 mV to 5.0 V				
Resolution	< 100 mV: 3 digits ≥ 100 mV: 4 digits				
Adjustment Range	Continuously adjustable				
1-Year Absolute Uncertainty, tcal $\pm 5^\circ\text{C}$	$\pm(2\%$ of output + 300 μV)	$\pm(3.5\%$ of output + 300 μV)	$\pm(4\%$ of output + 300 μV)	$\pm(5.5\%$ of output + 300 μV)	$\pm(6\%$ of output + 300 μV)
Flatness ^[1] (relative to 50 kHz)	not applicable	$\pm(1.5\%$ of output + 100 μV)	$\pm(2\%$ of output + 100 μV)	$\pm(3.5\%$ of output + 100 μV)	$\pm(4\%$ of output + 100 μV)
Short-Term Amplitude Stability	$\leq 1\%$ ^[2]				
Frequency Characteristics					
Resolution	10 kHz				
1-Year Absolute Uncertainty, tcal $\pm 5^\circ\text{C}$	$\pm(0.33\text{ ppm} \pm 0.4\text{ Hz})$ ^[4]				
Distortion Characteristics ^[3]					
2 nd Harmonic	$\leq -33\text{ dBc}$				
3 rd and Higher Harmonics	$\leq -38\text{ dBc}$				
<p>[1] As measured near Oscilloscope bandwidth frequency.</p> <p>[2] Within one hour after reference amplitude setting, provided temperature varies no more than $\pm 5^\circ\text{C}$.</p> <p>[3] Harmonics above 500 MHz are typical.</p> <p>[4] As measured with a 1-second gate on a Fluke 6680B or equivalent.</p>					

1-16. Time Marker Specifications

Note

If you ordered the GHz Option, the following specification table is superseded by the table with the same heading in Chapter 8 of the 5820A Operators Manual.

Time Marker into 50 Ω	5 s to 50 ms	20 ms to 100 ns	50 ns to 20 ns	10 ns	5 ns to 2 ns
Wave Shape	Spike or Square	Spike, Square, or 20 %-pulse	Spike or Square	Square or Sine	Sine
Typical Output Level	$> 1\text{ V p-p}$ ^[1]	$> 1\text{ V p-p}$ ^[1]	$> 1\text{ V p-p}$ ^[1]	$> 1\text{ V p-p}$ ^[1]	$> 1\text{ V p-p}$
Typical Jitter (p-p)	$< 10\text{ ppm}$	$< 1\text{ ppm}$	$< 1\text{ ppm}$	$< 1\text{ ppm}$	$< 1\text{ ppm}$
Sequence	5-2-1 from 5 s to 2 ns (e.g., 500 ms, 200 ms, 100 ms)				
Adjustment Range	At least $\pm 10\%$ around each sequence value indicated above				
Amplitude Resolution	4 digits				
1-Year Absolute Uncertainty, tcal $\pm 5^\circ\text{C}$ ^[1]	$\pm(2.5\text{ ppm} + 5\ \mu\text{Hz})$ ^[2]	$\pm 0.33\text{ ppm}$	$\pm 0.33\text{ ppm}$	$\pm 0.33\text{ ppm}$	$\pm 0.33\text{ ppm}$
<p>[1] Time marker uncertainty is $\pm 50\text{ ppm}$ when measured off of cardinal points: 5 s, 2 s, 1 s, 500 ms, 200 ms, 100 ms, 50 ms, 20 ms, 10 ms, 5 ms, 2 ms, 1 ms, 500 μs, 200 μs, 100 μs, 50 μs, 20 μs, 10 μs, 5 μs, 2 μs, 1 μs, 500 ns, 200 ns, 100 ns, 50 ns, 20 ns, 10 ns, 5 ns and 2 ns.</p> <p>[2] As an example, a 5s [0.2 Hz] marker would have an uncertainty of: $0.2\text{ Hz} * 2.5\text{ ppm} + 5\ \mu\text{Hz} = 5.5\ \mu\text{Hz}$. The valid values are 0.2000055 to 0.1999945 Hz or 4.9998625 s to 5.0001375 s.</p>					

1-17. Wave Generator Specifications

Wave Generator Characteristics	Square Wave and Sine Wave into 50 Ω or 1 MΩ	Triangle Wave into 50 Ω or 1 MΩ
Amplitude		
Range	into 1 MΩ: 1.8 mV to 55 V p-p into 50 Ω: 1.8 mV to 2.5 V p-p	into 1 MΩ: 1.8 mV to 55 V p-p into 50 Ω: 1.8 mV to 2.5 V p-p
1-Year Absolute Uncertainty, tcal ±5 °C, 10 Hz to 10 kHz	±(3 % of p-p output + 100 μV)	±(3 % of p-p output + 100 μV)
Sequence	1-2-5 (e.g., 10 mV, 20 mV, 50 mV)	1-2-5 (e.g., 10 mV, 20 mV, 50 mV)
Typical DC Offset Range	0 to ±(≥40 % of p-p amplitude) ^[1]	0 to ±(≥40 % of p-p amplitude) ^[1]
Ramp Linearity ^[2]		Better than 0.1 % 10 Hz to 10 kHz ^[3]
Frequency		
Range	0.01 Hz to 100 kHz	0.01 Hz to 100 kHz
Resolution	4 or 5 digits depending upon Frequency	4 or 5 digits depending upon Frequency
1-Year Absolute Uncertainty, tcal ±5 °C ^[5]	±(2.5 ppm + 5 μHz) ^[4]	±(2.5 ppm + 5 μHz) ^[4]
<p>[1] The DC offset plus the wave signal must not exceed 30 V rms.</p> <p>[2] Applies to the 10 % to 90 % of the triangle waveform 500 mV p-p to 10 V p-p.</p> <p>[3] No specification below 10 Hz or above 10 kHz.</p> <p>[4] With 10 MHz external reference selected, the uncertainty becomes that of the external clock plus 5 μHz.</p> <p>[5] Uncertainties below 10 Hz are typical.</p> <p>[6] Square wave rise/fall time typically less than 500 ns.</p>		

1-18. 1 ns Pulse Generator Specifications

Pulse Generator Characteristics	Positive pulse into 50 Ω
Typical Rise/fall Time	≤500 ps
Typical Available Amplitudes	1.5 V, 600 mV, 150 mV, 60 mV, 15 mV
Pulse Width	
Range ^[1]	1 ns to 500 ns
Uncertainty	5 % ±200 ps
Pulse Period	
Pulse width < 1 ns	20 ms to 200 ns
1 ns ≤ Pulse width ≤ 9.9 ns	20 ms to 200 ns
10 ns ≤ Pulse width ≤ 79.9 ns	20 ms to 2 μs
80 ns ≤ Pulse width ≤ 500 ns	20 ms to 10 μs
Resolution	4 or 5 digits depending upon frequency and width
1-Year Absolute Uncertainty, tcal ≤ 5 °C	±0.33 ppm
Pulse Skew with Trigger^[3]	
Range ^[2]	+30 ns to -10 ns with 250 ps resolution
Uncertainty ^[4]	±500 ps
<p>[1] May generate pulses below 1 ns but pulse width accuracy is not specified</p> <p>[2] Assumes that trigger is used in divide by 1 mode. Other divide modes are not specified.</p> <p>[3] Pulse skew measured from 30 % of trigger signal amplitude to 30 % of pulse range amplitude.</p> <p>[4] Uncertainty specification applies only for pulse periods that are 3 μs or greater in duration. Otherwise, skew uncertainty is typical.</p>	

1-19. Trigger Signal Specifications (Pulse Function)

Pulse Period	Division Ratio	Amplitude into 50 Ω (p-p)	Typical Rise Time
20 ms to 200 ns	off/1/10/100	≥ 1 V	≤ 2 ns ok
Skew between Pulse and Trigger programmable from -10 ns to +30 ns			

1-20. Trigger Signal Specifications (Time Marker Function)

Time Marker Period	Division Ratio	Amplitude into 50 Ω (p-p)	Typical Rise Time
5 s to 35 ms	off/1	≥ 1 V	≤ 2 ns
34.9 ms to 750 ns	off/1/10/100	≥ 1 V	≤ 2 ns
749 ns to 7.5 ns	off/10/100	≥ 1 V	≤ 2 ns
7.5 ns to 2 ns	off/100	≥ 1 V	≤ 2 ns

1-21. Trigger Signal Specifications (Edge Function)

Edge Signal Frequency	Division Ratio	Typical Amplitude into 50 Ω (p-p)	Typical Rise Time	Typical Lead Time
1 kHz to 10 MHz	off/1	≥ 1 V	≤ 2 ns	40 ns

1-22. Trigger Signal Specifications (Square Wave Voltage Function)

AC Voltage Frequency	Division Ratio	Typical Amplitude into 50 Ω (p-p)	Typical Rise Time	Typical Lead Time
10 Hz to 10 kHz	off/1	≥ 1 V	≤ 2 ns	2 μs

1-23. Trigger Signal Specifications (TV)

Trigger Signal Type	Parameters
Frame Formats	Selectable NTSC, SECAM, PAL, PAL-M
Polarity	Positive or negative
Amplitude into 50 Ω (p-p)	Adjustable 0 to 1.5 V p-p into 50 ohm load, (±7 % accuracy)
Line Marker	Selectable Line Video Marker

1-24. Tunnel Diode Drive Capability

TD Pulse Drive	Square wave at 100 Hz to 100 kHz with variable amplitude of 60 V to 100 V p-p
----------------	---

1-25. Oscilloscope Input Resistance Measurement Specifications

Scope Input Selected	50 Ω	1 MΩ
Measurement Range	40 Ω to 60 Ω	500 kΩ to 1.5 MΩ
Uncertainty	0.1 %	0.1 %

1-26. Oscilloscope Input Capacitance Measurement Specifications

Scope Input Selected	1 MΩ
Measurement Range	5 pF to 50 pF
Uncertainty	±(5 % of input + 0.5 pF) ^[1]

[1] Measurement made within 30 minutes of capacitance zero reference.

1-27. Overload Measurement Specifications

The Overload test function applies for dc or ac (1 kHz square wave) power into the 50 Ω oscilloscope input and monitors the current. The time measurement counter indicates the time duration of the applied overload signal. When the input protection circuit reacts and opens the 50 Ω load, the calibrator indication is set to 'off' on the right hand side of the display. In order to prevent front end damage to the oscilloscope, a limited amount of energy is applied by a user selectable time limit.

Source Voltage	Typical 'On' current Indication	Typical 'Off' current Indication	Typical Maximum Time Limit DC or AC 1 kHz AC
5 V to 9 V	100 mA to 180 mA	10 mA	settable 5 to 60 sec

1-28. External Reference Input Specifications

The External Reference Input selection allows the user to provide their own high stability 10 MHz reference clock for the 5820A for all functions except the Wave Generator function. For all other modes, the frequency stability is determined by the external reference stability. The external reference input must be between 1 to 5 V p-p.

1-29. Auxiliary Input/Output Specifications

The maximum input voltage for the auxiliary input is 40 V p-p.

Channel Configuration	Frequency	Typical Loss	Typical VSWR
1-Channel	< 600 MHz	≤ 1.1 dB	≤ 1.2:1
1-Channel	600 MHz to 1 GHz	≤ 1.3 dB	≤ 1.4:1
1-Channel	1 GHz to 2.0 GHz	≤ 2.0 dB	≤ 1.7:1
1-Channel	2 GHz to 3 GHz	≤ 3.0 dB	≤ 2.0:1
5-Channel	< 600 MHz	≤ 1.1 dB	≤ 1.2:1
5-Channel	600 MHz to 1 GHz	≤ 1.3 dB	≤ 1.4:1
5-Channel	1 GHz to 2.0 GHz	≤ 2.0 dB	≤ 1.7:1
5-Channel	2 GHz to 3 GHz	≤ 3.0 dB	≤ 2.0:1

1-30. Current Output Specifications

Parameter	DC	Squarewave
Amplitude (compliance voltage 2 V max)	±100 µA to ±100 mA	100 µAp-p to 100 mAp-p
Accuracy	±(0.25 % + 0.5 µA)	±(0.25 % + 0.5 µA) ^[1]
Frequency Range	N/A	10 Hz to 100 kHz
Accuracy	N/A	2.5 ppm +5 µHz
Steps	N/A	1,2,5 or continuous
[1] Amplitude uncertainty for frequency range 45 Hz to 1 kHz at < 120 mV compliance voltage.		

Chapter 2

Preparing for Operation

	Title	Page
2-1.	Introduction.....	2-3
2-2.	Unpacking and Inspection	2-3
2-3.	Replacing The Fuse	2-4
2-4.	Selecting Line Voltage.....	2-4
2-5.	Connecting To Line Power	2-5
2-6.	How to Contact Fluke.....	2-7
2-7.	Placement and Rack Mounting	2-7
2-8.	Cooling Considerations.....	2-8

 **Warning**

To avoid electric shock, read this chapter and follow the instructions given. The 5820A Calibrator can supply lethal voltage. If any output channel is energized with a hazardous voltage, always treat the unused channels as if there are hazardous live voltages present.

2-1. Introduction

This chapter provides instructions for unpacking and installing the 5820A, selecting the line voltage, replacing the fuse, and connecting to line power. For instructions for cable connections other than line power, refer to the following chapters:

- UUT (Unit Under Test) connections: Chapter 4
- IEEE-488 parallel interface connection: Chapter 5
- RS-232-C serial interface connection: Chapter 5
- Auxiliary amplifier connections: Chapter 4

2-2. Unpacking and Inspection

Inspect the calibrator carefully for damage and immediately report any damage to the shipper. The shipping container includes instructions for inspection and claims.

When you unpack the calibrator, check for all the standard equipment listed in Table 2-1 and check the shipping order for any additional items ordered. Refer to Chapter 9 for more information. Report any shortage to the place of purchase or to the nearest Fluke Technical Service Center (see “Service Information” in this chapter). For a performance test, refer to Chapter 7.

If reshipping the calibrator, use the original container. If it is not available, you can order a new container from Fluke by indicating the calibrator's model and serial number.

Table 2-1. Standard Equipment

Item	Model or Part Number
Calibrator	5820A
Line Power Cord	See Table 2-2 and Figure 2-2
5820A Operator Manual	802154
Certificate of Calibration	Form G749
Cable assembly, COAX, N(M), BNC (M), 1M	P/N 688960
2 EA with 5820A, 5 EA with 5820A-5C	
Soft Case for storage of output cables	P/N 603115

2-3. Replacing The Fuse



To avoid fire, be sure to install the proper fuse and to set the voltage select switch to the proper voltage. For 100 V and 120 V, use 2A/250V SB (time delay). For 220 V and 240 V, use 1A/250V SB (time delay).

The line power fuse is accessible on the rear panel. The fuse rating is 2A/250V time delay fuse for the 100V/120V line voltage setting; 1A/250V time delay fuse for the 220V/240V line voltage setting.

To check or replace the fuse, refer to Figure 2-1 and proceed as follows:

1. **Disconnect line power.**
2. Open the fuse compartment by inserting a screwdriver blade in the tab located at the left side of the compartment and gently pry until it can be removed with the fingers.
3. Remove the fuse from the compartment for replacement or verification. Be sure the correct fuse is installed.
4. Reinstall the fuse compartment by pushing it back into place until the tab locks.

2-4. Selecting Line Voltage

The calibrator arrives from the factory configured for the line voltage normally appropriate for the country of purchase, or as specified at the time of your purchase order. You can operate the 5820A Calibrator from one of four line voltage settings: 100 V, 120 V, 200 V, and 240 V (47 to 63 Hz). To check the line voltage setting, note the voltage setting visible through the window in the power line fuse compartment cover (Figure 2-1). The allowed line voltage variation is 10 % above or below the line voltage setting.

To change the line voltage setting, complete the following procedure:

1. **Disconnect line power.**
2. Open the fuse compartment by inserting a screwdriver blade in the tab located at the left side of the compartment and gently pry until it can be removed with the fingers.
3. Remove the line voltage selector assembly by gripping the line voltage indicator tab with pliers and pulling it straight out of its connector.
4. Rotate the line voltage selector assembly to the desired voltage and reinsert.
5. Verify the appropriate fuse for the selected line voltage and reinstall the fuse compartment by pushing it back into place until the tab locks.

2-5. Connecting To Line Power

Warning

To avoid shock hazard, connect the factory supplied three-conductor line power cord to a properly grounded power outlet. Do not use a two-conductor adapter or extension cord; this will break the protective ground connection.

Use the rear-panel ground terminal for a protective grounding wire if there is any question as to instrument earth grounding.

The calibrator is shipped with the appropriate line power plug for the country of purchase. If you need a different type, refer to Table 2-2 and Figure 2-2 for a list and illustration of the line power plug types available from Fluke.

After you verify that the line voltage selection is set correctly and that the correct fuse for that line voltage is installed, connect the calibrator to a properly grounded three-prong outlet.

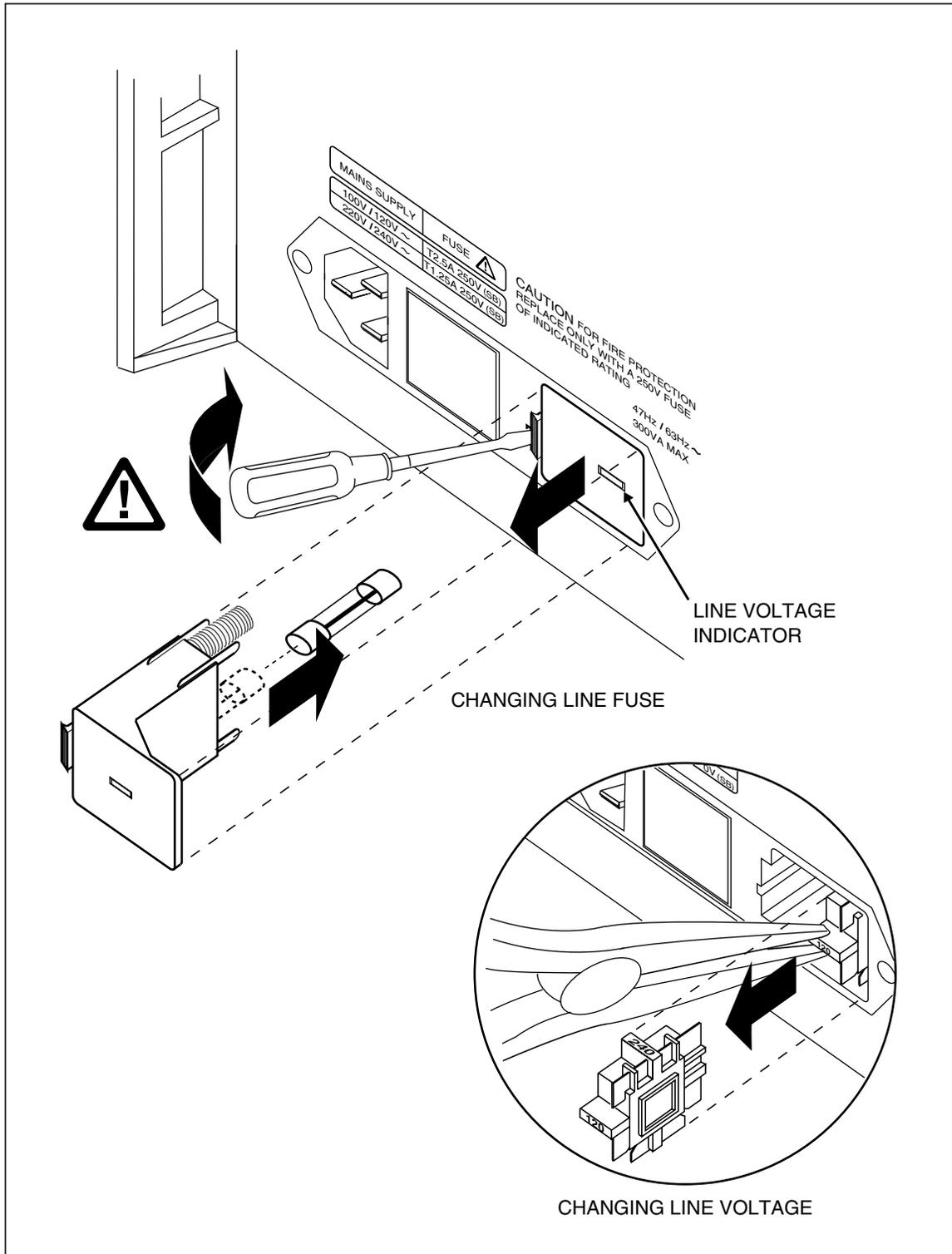

Figure 2-1. Accessing the Fuse and Selecting Line Voltage

aag066f.eps

Table 2-2. Line Power Cord Types Available from Fluke

Type	Voltage/Current	Fluke Option Number
North America	120 V/15 A	LC-1
North America	240 V/15 A	LC-2
Universal Euro	220 V/16 A	LC-3
United Kingdom	240 V/13 A	LC-4
Switzerland	220 V/10 A	LC-5
Australia	240 V/10 A	LC-6
South Africa	240 V/5 A	LC-7

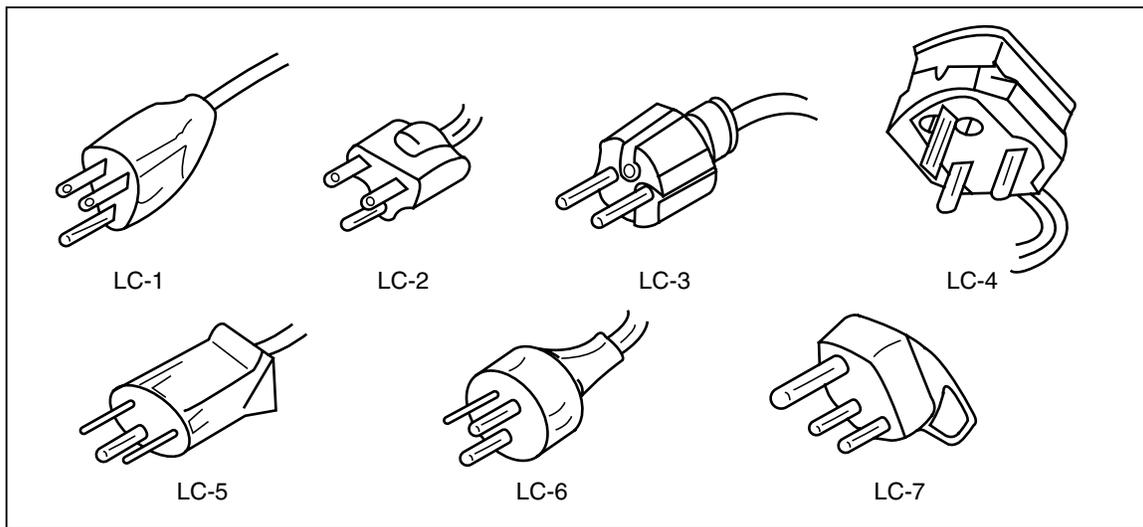

Figure 2-2. Line Power Cord Types Available from Fluke

oq009f.eps

2-6. How to Contact Fluke

To contact Fluke, call:

USA: 1-888-99-FLUKE (1-888-993-5853)
 Canada: 1-800-36-FLUKE (1-800-363-5853)
 Europe: +31 402-675-200
 Japan: +81-3-3434-0181
 Singapore: +65-738-5655
 Anywhere in the world: +1-425-446-5500

For additional information about Fluke, its products, and services, visit Fluke's web site at: www.fluke.com

To register your product, visit register.fluke.com.

Refer to the Fluke catalog or contact a Technical Service Center representative for the module exchange procedure.

2-7. Placement and Rack Mounting

You may place the calibrator on a bench top or mount it in a standard-width, 24-inch (61-cm) deep equipment rack. For bench-top use, the calibrator has non-slipping, non-

marring feet. To mount the calibrator in an equipment rack, use the 5820A Rack Mount Kit, Model Y5537. The rack mount kit has instructions for rack mounting the calibrator.

2-8. Cooling Considerations

Warning

To avoid risk of injury, never operate or power the 5820A Calibrator without the fan filter in place.

Caution

To avoid damage to the calibrator, make sure the calibrator is kept at the coolest possible temperature and air flow is not restricted. Damage caused by overheating may occur if the area around the air intake is restricted, the intake air is too warm, or the air filter becomes clogged.

Baffles direct cooling air from the fan throughout the chassis to internally dissipate heat during operation. The accuracy and dependability of all internal parts of the calibrator are enhanced by maintaining the coolest possible internal temperature. You can lengthen the life of the calibrator and enhance its performance by observing the following rules:

- The area around the air filter must be at least 3 inches from nearby walls or rack enclosures.
- The exhaust perforations on the sides of the calibrator must be clear of obstructions.
- The air entering the instrument must be at room temperature: make sure the exhaust air from another instrument is not directed into the fan inlet.

Clean the air filter every 30 days or more frequently if you operate the calibrator in a dusty environment. (See Chapter 7 for instructions on cleaning the air filter.)

Chapter 3

Feature

	Title	Page
3-1.	Introduction.....	3-3
3-2.	Front Panel Features	3-3
3-3.	Rear Panel Features	3-3
3-4.	Setup Softkey Menu Trees.....	3-10

3-1. Introduction

This chapter is a reference for the functions and locations of the 5820A Calibrator's front and rear panel features. Please read this information before operating the calibrator. Chapter 4 provides the front panel operating instructions for the calibrator; Chapter 5 provides the remote operating instructions.

3-2. Front Panel Features

Refer to Figure 3-1 for the front panel features (including all controls, displays, indicators, and terminals) and Table 3-1 for a description of each front panel feature.

3-3. Rear Panel Features

Refer to Figure 3-2 for panel features (including all terminals, sockets, and connectors) and Table 3-2 for a description of each rear panel feature.

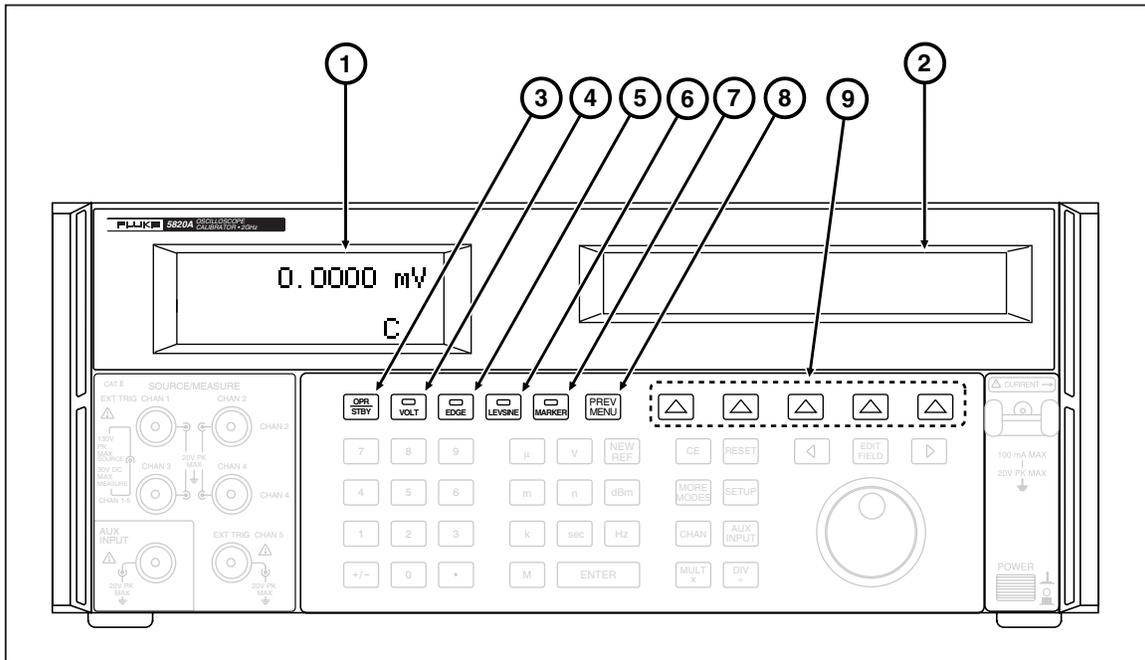

Figure 3-1. Front Panel View

yh004f.eps

Table 3-1. Front Panel Features

<p>① Output Display</p> <p>The Output Display is a two-line backlit LCD that shows output amplitudes, frequency and calibrator status. Output values (or potential output values if in standby) display using up to seven digits plus a polarity sign. Output frequencies (or potential output frequencies if the 5820A is in standby) display using four digits. Calibrator status is indicated by displaying the following abbreviations:</p> <p>OPR Displayed when an output is active at the front panel terminals or auxiliary amplifier terminals.</p> <p>SBY Displayed when the 5820A is in standby.</p> <p>ADDR Displayed when the 5820A is addressed over the IEEE-488 interface.</p> <p>u When you change the output, a “u” (unsettled) displays for a second or two until the output settles to within the specified accuracy.</p> <p>m Displayed when the calibrator is making a measurement.</p> <p>? Displayed when the amplitude is specified as typical only, and/or reduced resolution. This occurs when operating the 5820A in the extended bandwidth mode.</p> <p>Cx Shows which channel is selected if the 5-channel option is installed. The channel is indicated by a “C” in the lower right corner of the output display.</p>
--

Table 3-1. Front Panel Features (cont.)

2	<p>Control Display</p> <p>The Control Display is a multipurpose backlit LCD used for displaying data entries, UUT error adjustments, softkey labels, and other prompts and messages. When there isn't enough room on the Output Display, output frequency displays on the Control Display. Softkey labels identify the function of the softkey directly below them. Several softkey labels together are called a menu. The changing menus provide access to many different functions through the five softkeys plus the PREV MENU key. (See Figure 3-3, Softkey Menu Tree.)</p>
3	<div style="display: flex; align-items: center; margin-bottom: 5px;"> <div style="border: 1px solid black; padding: 2px; margin-right: 5px; font-size: 8px;">OPR STBY</div> </div> <p>The OPR (Operate) key places the 5820A in the operate mode. The operate mode is indicated by "OPR" in the lower left corner of the output display and the lit indicator on the OPR key.</p> <p>The STBY (Standby) key places the 5820A in the standby mode. Standby mode is indicated by "SBY" in the lower left corner of the output display. In standby mode, the NORMAL and AUX output terminals are internally disconnected from the 5820A. The 5820A normally starts up in the standby mode. The 5820A automatically switches to standby if one of the following occurs:</p> <ul style="list-style-type: none"> Pressing the RESET key. Selecting a voltage at rms value ≥ 33 V when the previous output voltage was less than 33 V.
4	<div style="display: flex; align-items: center; margin-bottom: 5px;"> <div style="border: 1px solid black; padding: 2px; margin-right: 5px; font-size: 8px;">VOLTAGE</div> </div> <p>The VOLTAGE key lets you select the voltage mode so you can calibrate the voltage gain by applying a dc or low frequency square wave signal and adjusting its gain to meet the height specified for different voltage levels, as designated by the graticle line divisions on the oscilloscope.</p>
5	<div style="display: flex; align-items: center; margin-bottom: 5px;"> <div style="border: 1px solid black; padding: 2px; margin-right: 5px; font-size: 8px;">EDGE</div> </div> <p>The EDGE key lets you select the edge mode so you can calibrate the edge response for your oscilloscope by using a square wave signal that has a fast leading edge rise-time.</p>
6	<div style="display: flex; align-items: center; margin-bottom: 5px;"> <div style="border: 1px solid black; padding: 2px; margin-right: 5px; font-size: 8px;">LEVEL SINE</div> </div> <p>The LEVEL SINE key lets you select the level sine mode so you can use a leveled sine wave, whose amplitude remains relatively constant over a range of frequencies, to check the oscilloscope's bandwidth.</p>
7	<div style="display: flex; align-items: center; margin-bottom: 5px;"> <div style="border: 1px solid black; padding: 2px; margin-right: 5px; font-size: 8px;">MARKER</div> </div> <p>The MARKER key lets you select the marker mode so you can generate a time marker signal from the Calibrator and match the time interval to the time divisions on the oscilloscope in order to calibrate the timing response.</p>
8	<div style="display: flex; align-items: center; margin-bottom: 5px;"> <div style="border: 1px solid black; padding: 2px; margin-right: 5px; font-size: 8px;">PREV MENU</div> </div> <p>The PREV MENU (Previous Menu) key recalls the previous set of menu choices. Each press of this key backs up one level of the menu tree until the display indicates the top level menu selection of the function selected.</p>
9	<p>Softkeys</p> <p>The functions of the five unlabeled blue softkeys are identified by labels on the Control Display directly above each key. The functions change during operation so that many different functions are accessible through these keys. A group of softkey labels is called a menu. A group of interconnected menus is called a menu tree.</p>

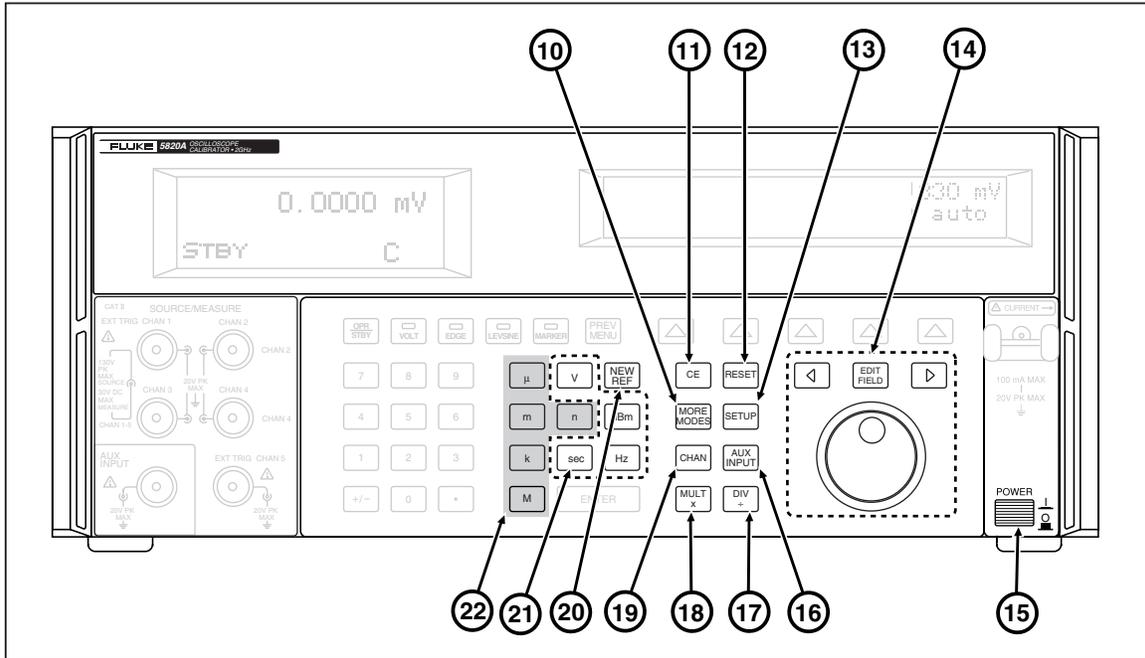

yh005f.eps

Figure 3-1. Front Panel View (cont.)

Table 3-1. Front Panel Features (cont.)

<p>⑩</p>	<p>MORE MODES</p> <p>The MORE MODES key allows you to change to additional modes not shown on the front panel keys.</p>
<p>⑪</p>	<p>CE</p> <p>The CE (Clear Entry) key clears a partially completed keypad entry from the Control Display.</p>
<p>⑫</p>	<p>RESET</p> <p>The RESET (Reset Calibrator) key aborts the current operating state of the 5820A and returns it to the power-up default state, except when operating under remote control.</p>
<p>⑬</p>	<p>SETUP</p> <p>The SETUP (Setup Menu) key puts the 5820A in the setup mode, displaying the setup menu in the control display. Setup options can be selected using the softkeys under the control display.</p>
<p>⑭</p>	<p>EDIT FIELD</p> <p>The EDIT FIELD (Edit Output Display Field) key and associated left/right arrow keys provide step adjustment of the output signals. If you press any of these keys or rotate the knob, a digit on the Output Display becomes highlighted and the output increments or decrements as the knob is rotated. If a digit rolls past 0 or 9, the digit to its left or right is carried. An error display appears on the Control Display, showing the difference between the original (reference) output and the new output.</p>

Table 3-1. Front Panel Features (cont.)

	<p>The <input type="button" value="◀"/> and <input type="button" value="▶"/> keys adjust the magnitude of changes by moving the highlighted digit. The <input type="button" value="EDIT FIELD"/> key allows you to move from voltage or current to frequency and back. In practice, for voltage and current outputs, the knob and arrow keys are used to adjust output until the UUT reads correctly. The error display then displays UUT deviation from the reference.</p>												
15	<p>The POWER (Primary Power) switch turns the power on and off. The switch is a latching push-push type. When the switch is latched, power is applied.</p>												
16	<p><input type="button" value="AUX INPUT"/></p> <p>The AUX INPUT key allows you set the calibrator to AUX INPUT mode which passes the signal present at the AUX INPUT connector to the selected output channel.</p>												
17	<p><input type="button" value="DIV ↓"/></p> <p>The DIV (Divide) key immediately changes the output to one tenth the reference value or the next lower cardinal value, depending on the mode.</p>												
18	<p><input type="button" value="MULT ×"/></p> <p>The MULT (Multiply) key immediately changes the output to ten times the reference value or the next higher cardinal value, depending on the mode.</p>												
19	<p><input type="button" value="CHANNEL"/></p> <p>The CHANNEL key lets you select the different available channels with the 5-channel option.</p>												
20	<p><input type="button" value="NEW REF"/></p> <p>The NEW REF (New Reference) key is active during error mode operation, and establishes the present output value as a new reference for UUT error computation</p>												
21	<p>Output Units Keys</p> <p>The output units keys determine the function of the 5820A. The output units are as follows:</p> <table style="width: 100%; border: none;"> <tr> <td style="border: 1px solid black; padding: 2px; width: 30px; text-align: center;">V</td> <td style="border: 1px solid black; padding: 2px; width: 30px; text-align: center;">Hz</td> </tr> <tr> <td style="border: 1px solid black; padding: 2px; width: 30px; text-align: center;">sec</td> <td style="border: 1px solid black; padding: 2px; width: 30px; text-align: center;">dBm</td> </tr> </table> <p>When you enter a frequency (Hz) value, the 5820A automatically switches to ac. When you enter a new signed (+ or -) output value without specifying Hz, the 5820A automatically switches back to dc (or enter "0" Hz to move back to volts dc).</p>	V	Hz	sec	dBm								
V	Hz												
sec	dBm												
22	<p>Multiplier Keys</p> <p>Select output value multipliers. The multiplier keys are as follows:</p> <table style="width: 100%; border: none;"> <tr> <td style="border: 1px solid black; padding: 2px; width: 30px; text-align: center;">m</td> <td style="padding: 2px;">milli (10⁻³ or 0.001)</td> <td style="border: 1px solid black; padding: 2px; width: 30px; text-align: center;">μ</td> <td style="padding: 2px;">micro (10⁻⁶ or 0.000001)</td> </tr> <tr> <td style="border: 1px solid black; padding: 2px; width: 30px; text-align: center;">k</td> <td style="padding: 2px;">kilo (10³ or 1,000)</td> <td style="border: 1px solid black; padding: 2px; width: 30px; text-align: center;">n</td> <td style="padding: 2px;">nano (10⁻⁹ or 0.000000001)</td> </tr> <tr> <td style="border: 1px solid black; padding: 2px; width: 30px; text-align: center;">M</td> <td style="padding: 2px;">mega (10⁶ or 1,000,000)</td> <td></td> <td></td> </tr> </table>	m	milli (10 ⁻³ or 0.001)	μ	micro (10 ⁻⁶ or 0.000001)	k	kilo (10 ³ or 1,000)	n	nano (10 ⁻⁹ or 0.000000001)	M	mega (10 ⁶ or 1,000,000)		
m	milli (10 ⁻³ or 0.001)	μ	micro (10 ⁻⁶ or 0.000001)										
k	kilo (10 ³ or 1,000)	n	nano (10 ⁻⁹ or 0.000000001)										
M	mega (10 ⁶ or 1,000,000)												

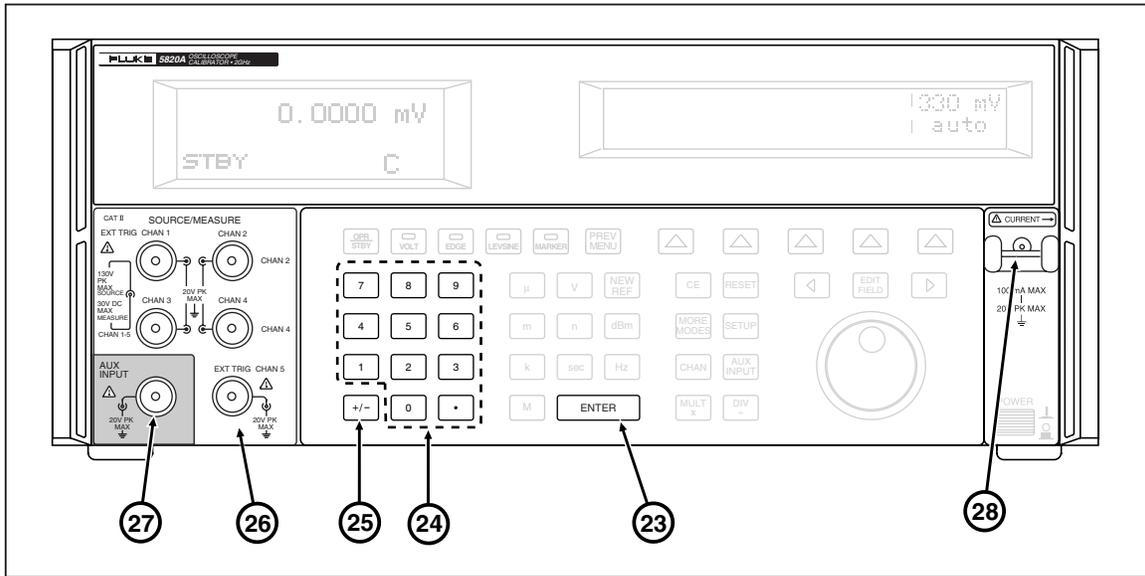

Figure 3-1. Front Panel View (cont.)

yh006f.eps

Table 3-1. Front Panel Features (cont.)

<p>23</p>	<p>ENTER</p> <p>The ENTER (Enter Value) key loads a newly entered output value shown on the Control Display into the 5820A, which appears on the Output Display. The new value can come from the numeric keypad. If you press ENTER without identifying the units for the entry, in most cases the 5820A keeps the units that were last used. This allows you, for example, to enter 1 mV, and then later enter 10 to obtain 10 V. (The "V" units were saved from the last entry, but not the multiplier, "m".) In the Error (edit) mode, ENTER with no value restores the output to the value of the reference.</p>
<p>24</p>	<p>Numeric Keypad</p> <p>Used to enter the digits of the output amplitude and frequency. The proper sequence to enter a value is to press the digits of the output value, a multiplier key (if necessary), an output units key, then ENTER. Press OPR STBY to enable the output. Pressing a digit key once the entry field is full, and pressing the decimal point key more than once in a single number sounds the beeper.</p>
<p>25</p>	<p>+/-</p> <p>The +/- (Polarity) key changes the polarity of the output for voltage mode. Press the +/- key then ENTER to toggle the output polarity.</p>
<p>26</p>	<p>1-Channel (Standard Configuration)</p> <p>The 1-Channel configuration supports automated calibration of oscilloscopes. The EXT TRIG (External Trigger) connector supports calibrating any oscilloscope requiring external triggering simultaneously with the output channel. The other three connectors are not connected.</p> <p>5-Channel Option</p> <p>The 5-Channel option supports automated calibration of multi-channel oscilloscopes without requiring connection changes. The two EXT TRIG (External Trigger) channel connectors support calibrating any oscilloscope requiring external triggering simultaneously with the output channels. In this option, you must select either Channel 1 or 5 to be the external trigger.</p>

Table 3-1. Front Panel Features (cont.)

- ②⑦ **AUX INPUT**
 The **AUX INPUT** (Auxiliary Input) connector allows you to connect an external signal generator to perform bandwidth checks up to 3.0 GHz. AUX INPUT works for 1- and 5-channel configurations.
- ②⑧ **Current Loop Bar**
 The **Current Loop Bar** provides a current output function for calibrating current probes. Specifications for the current output function can be found in Chapter 1.

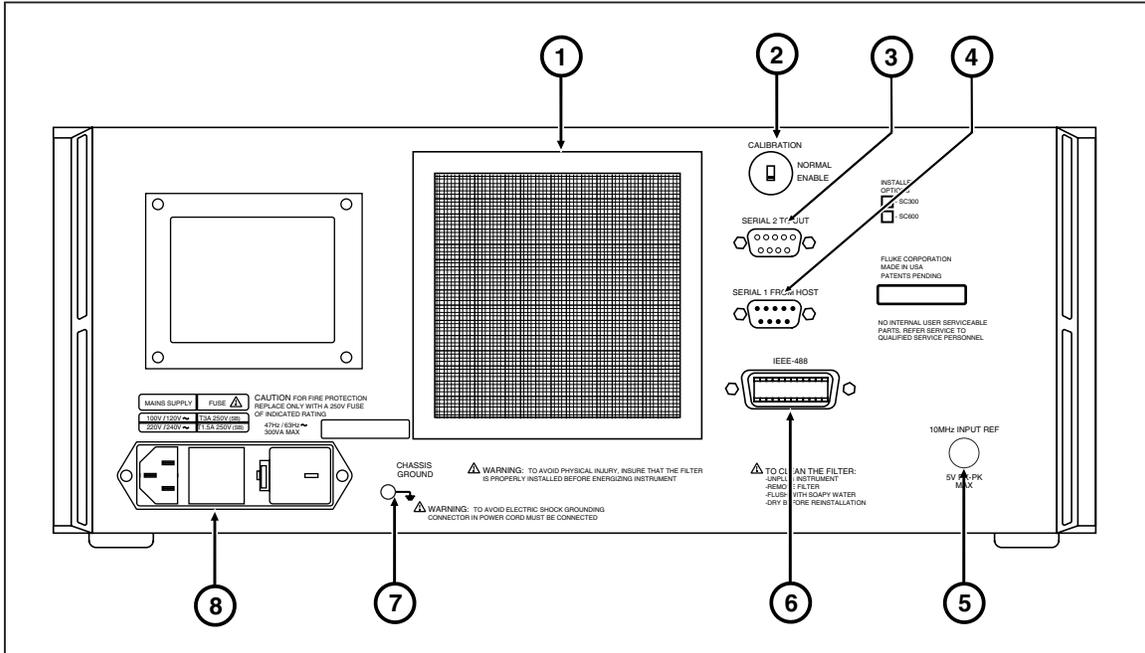

Figure 3-2. Rear Panel View

oq007f.eps

Table 3-2. Rear Panel Features

- ① The **Fan Filter** covers the air intake to keep dust and debris out of the chassis air baffles. The 5820A fan provides a constant cooling air flow throughout the chassis. Fan filter maintenance is described in Chapter 7.
- ② The **CALIBRATION NORMAL/ENABLE** slide switch selects write enable and disable the nonvolatile memory that stores calibration constants. Switching to **ENABLE** allows changes to be written into memory, and switching to **NORMAL** protects data in memory from being overwritten. The switch is recessed to allow it to be covered with a calibration sticker to guarantee calibration integrity.
- ③ The **SERIAL 2 TO UUT** connector is for transmitting and receiving RS-232 serial data between the 5820A and an RS-232 port on a Unit Under Test (UUT). Chapter 6 describes how to use the RS-232 serial interface for UUT communications.

Table 3-2. Rear Panel Features (cont.)

④	The SERIAL 1 FROM HOST connector is for remote control of the 5820A and for transmitting internal-constant RS-232 serial data to a monitor or host computer. Chapter 5 describes how to use the RS-232 serial interface for remote control.
⑤	The External Reference connector is for applying an optional external clock signal to the 5820A. This replaces the normal internal 10 MHz clock signal in the 5820A. Frequency accuracy of the 5820A is governed by the frequency accuracy of the clock signal internal or external.
⑥	The IEEE-488 connector is a standard parallel interface for operating the 5820A in remote control as a Talker/Listener on the IEEE-488 bus. Refer to Chapter 5 for bus connection and remote programming instructions.
⑦	 Warning
	<p>To avoid shock hazard, connect the factory supplied three-conductor line power cord to a properly grounded power outlet. Do not use a two-conductor adapter or extension cord; this will break the protective ground connection.</p> <p>Use the rear-panel ground terminal for a protective grounding wire if there is any question as to instrument earth grounding.</p>
	The CHASSIS GROUND binding post is internally grounded to the chassis. If the 5820A is the location of the ground reference point in a system, this binding post can be used for connecting other instruments to earth ground. Refer to “Connecting the Calibrator to a UUT” in Chapter 4 for details.
⑧	The AC Power Input Module provides a grounded three-prong connector that accepts the line power cord, a switch mechanism to select the operating line voltage, and a line power fuse. See Chapter 2 for information on selecting the operating line voltage, and fuse rating and replacement information.

3-4. Setup Softkey Menu Trees

Figures 3-3 and 3-4 identify the Setup softkeys. The Setup softkeys are associated with the 5820A Calibrator front panel **SETUP** key. The functions of the five softkeys are identified by label information displayed directly above each key. The softkey labels change during operation so that many different functions are quickly accessible.

A group of softkey labels is called a menu. A group of interconnected menus is called a menu tree. Figure 3-3 shows the SETUP menu tree structure; Figure 3-4 describes each SETUP menu tree display. Table 3-3 shows the factory default settings for the SETUP menu tree. To return the SETUP menus to their default values, use the softkey SETUP in the Format NV Memory menu (see Figure 3-4, menu F).

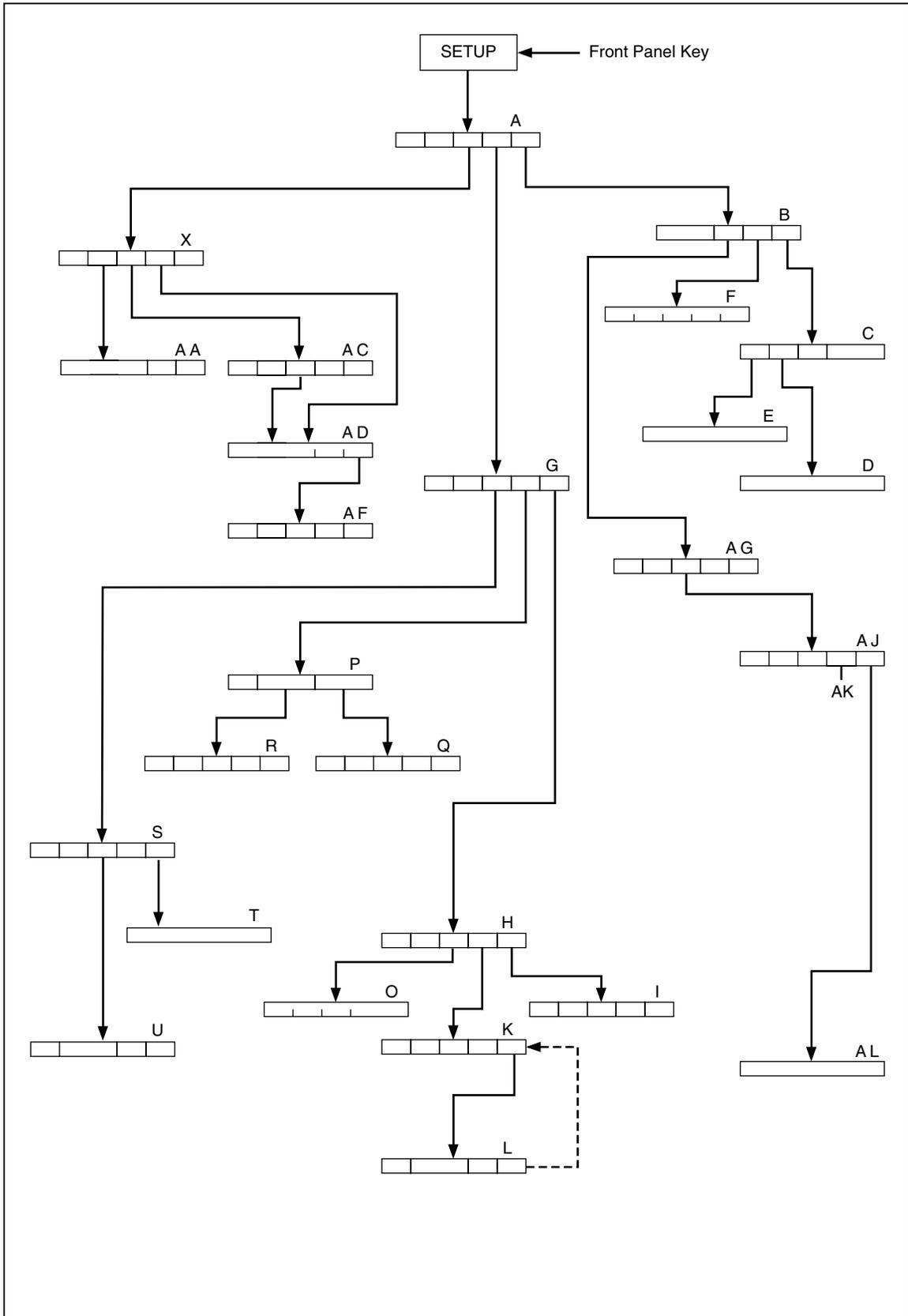

Figure 3-3. SETUP Softkey Menu Tree

oq008f.eps

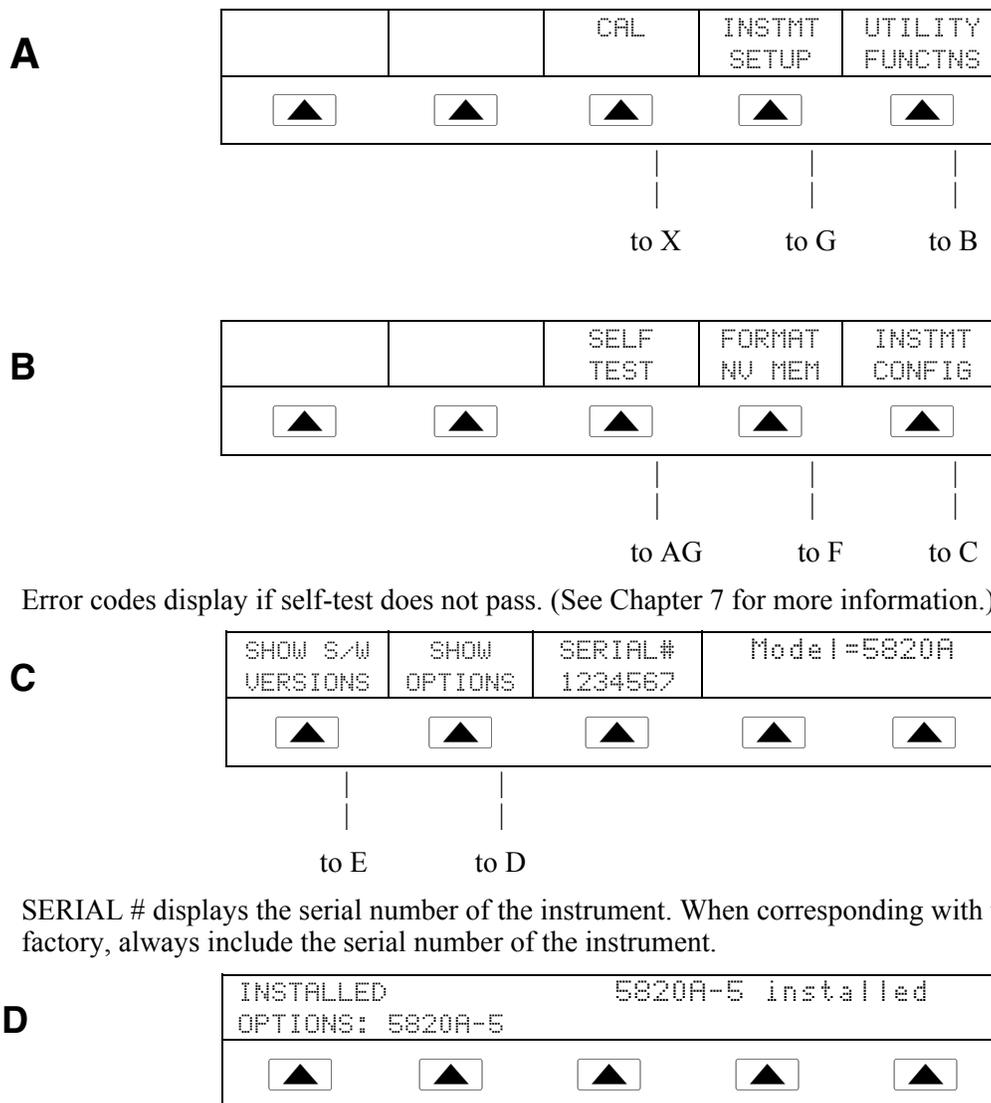
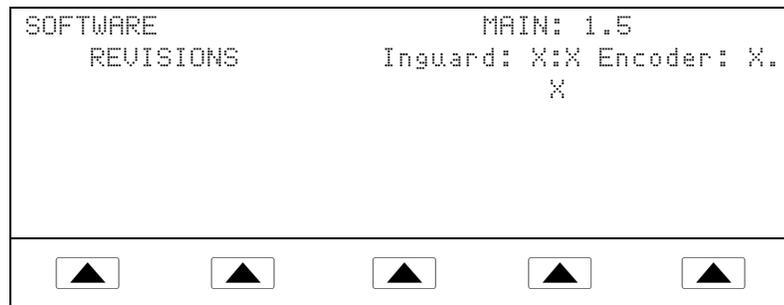

Figure 3-4. SETUP Softkey Menu Displays

Figure 3-5.
SETUP Softkey
Menu Displays

E



Actual revision numbers replace X.X for each of the above.

F



Use Format NV Memory (non-volatile) with caution. Changes are non-reversible. The softkeys function only when the rear-panel CALIBRATION switch is set to ENABLE, except for the softkey SETUP, which is not dependent on the CALIBRATION switch position.

G

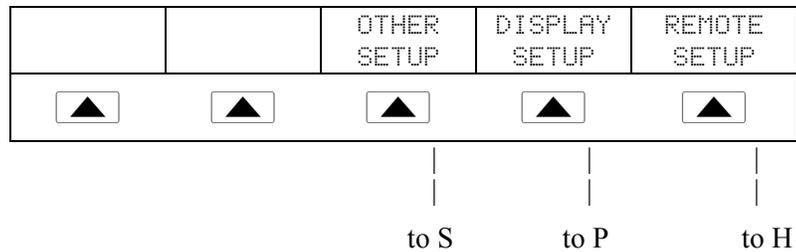

H

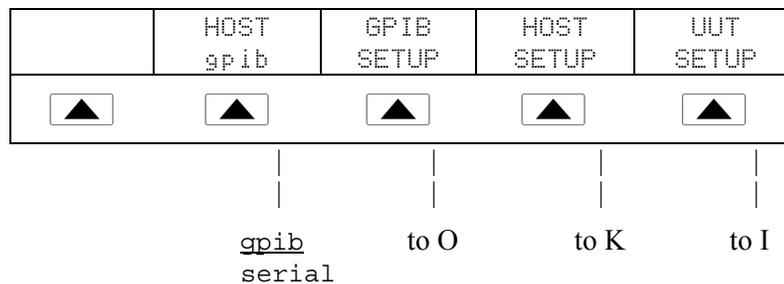

HOST selects the IEEE-488 (gpib) (factory default) parallel port or RS-232 (serial) port. You cannot operate both IEEE-488 and RS-232 simultaneously. All factory defaults are underlined.

Figure 3-4. SETUP Softkey Menu Displays (cont.)

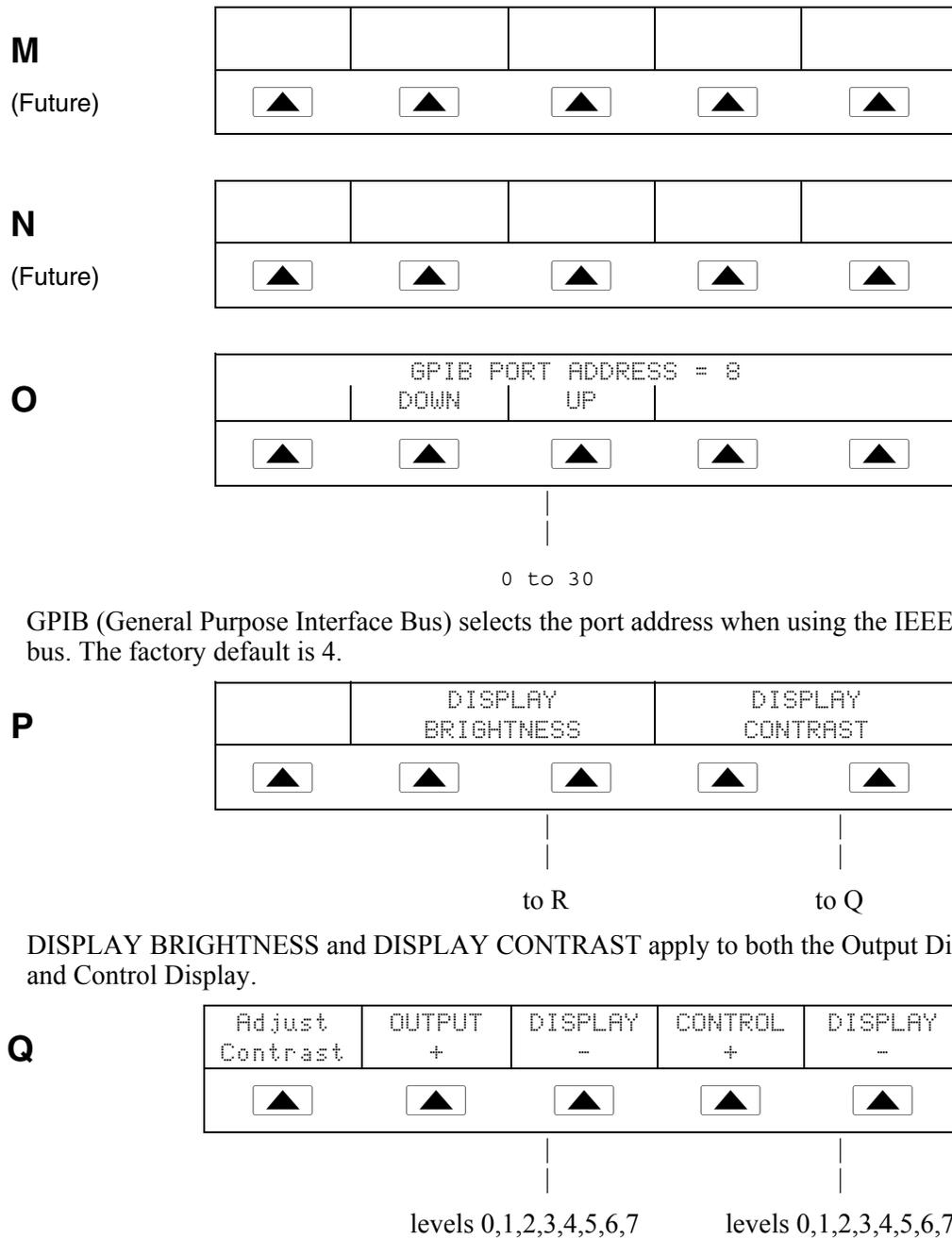
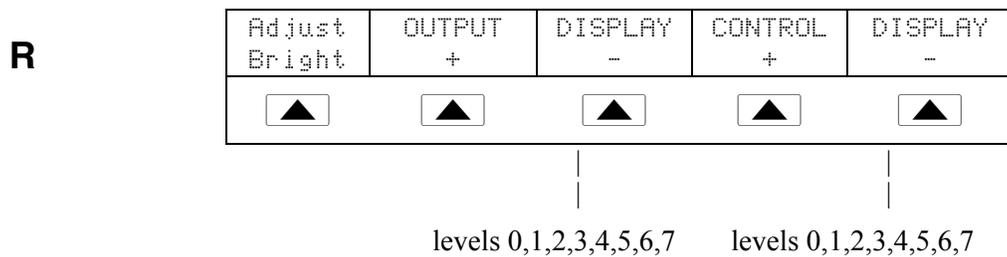
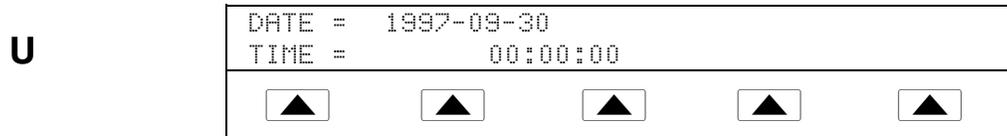
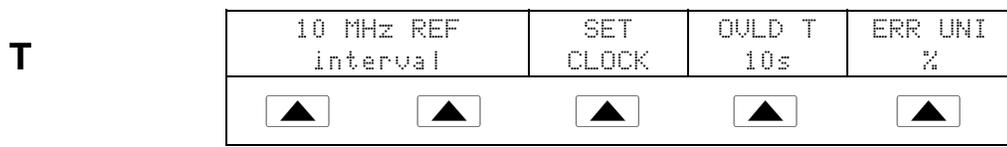
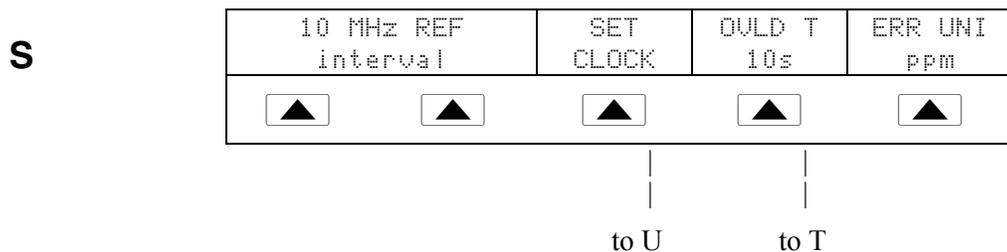

Figure 3-4. SETUP Softkey Menu Displays (cont.)



The Output Display and Control Display has eight levels of brightness, 0 to 7, for. Each may have its own level of contrast. The factory defaults are 1 and 0.



Select your date and time.

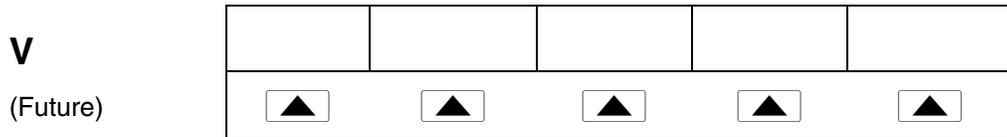
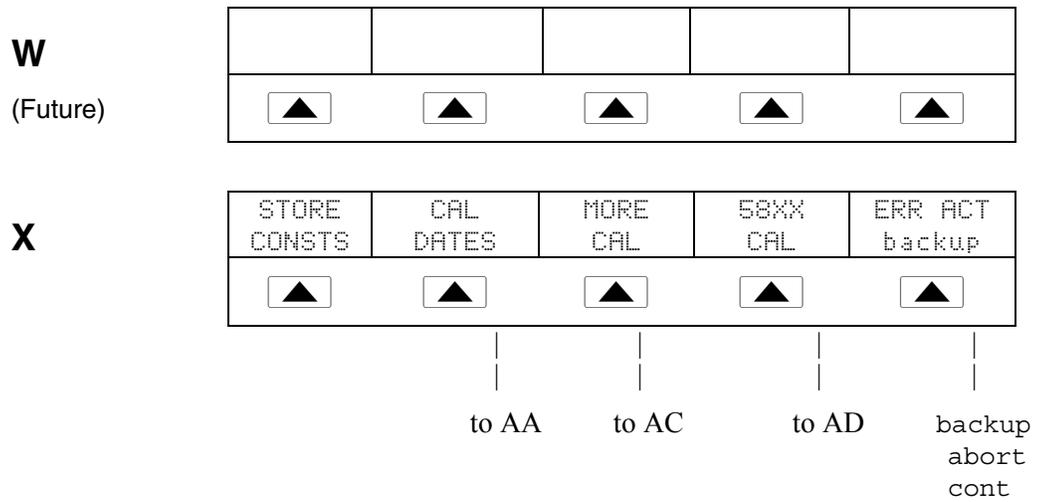

Figure 3-4. SETUP Softkey Menu Displays (cont.)



Select the desired CAL (Calibration) feature: STORE CONSTS to store calibration constants and CAL DATES to review when the 5820A Calibrator was last calibrated. The 5820A-5 option is available if you have the 5-channel option loaded. Otherwise that softkey is blank. START CAL starts the calibration. ERR ACT (Error Action) sets the backup, abort, or cont (continue).

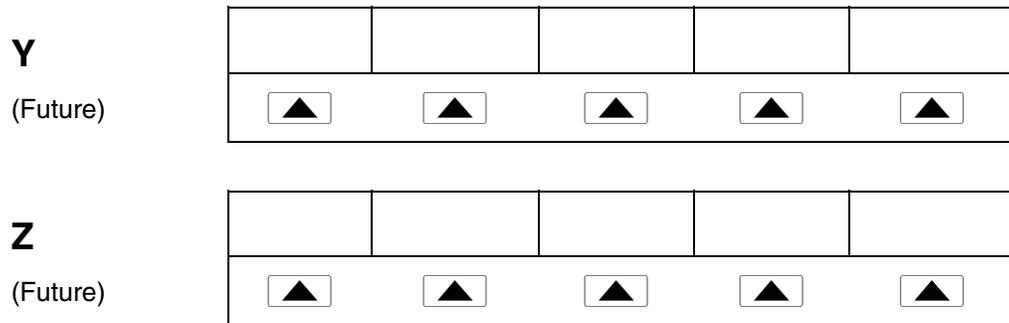
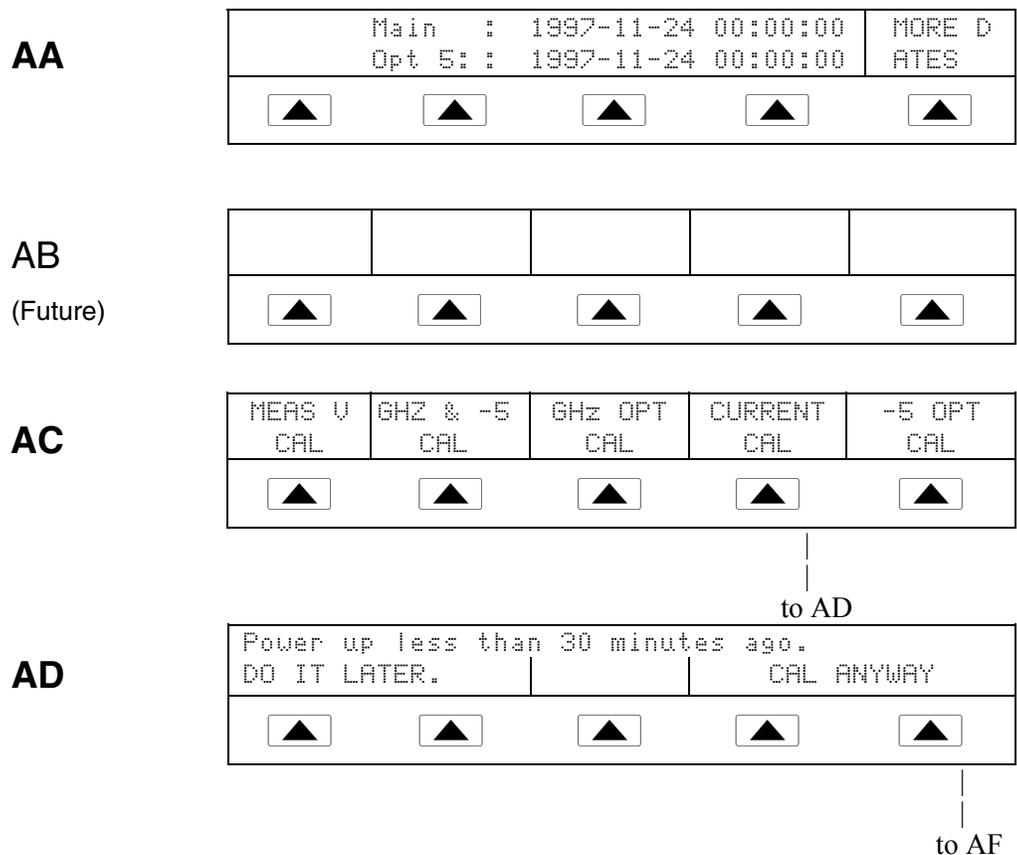

Figure 3-4. SETUP Softkey Menu Displays (cont.)



GO ON and ABORT softkeys are used in the 5820A Calibrator calibration procedure. See the *5820A Service Manual* for more information.

Figure 3-4. SETUP Softkey Menu Displays (cont.)

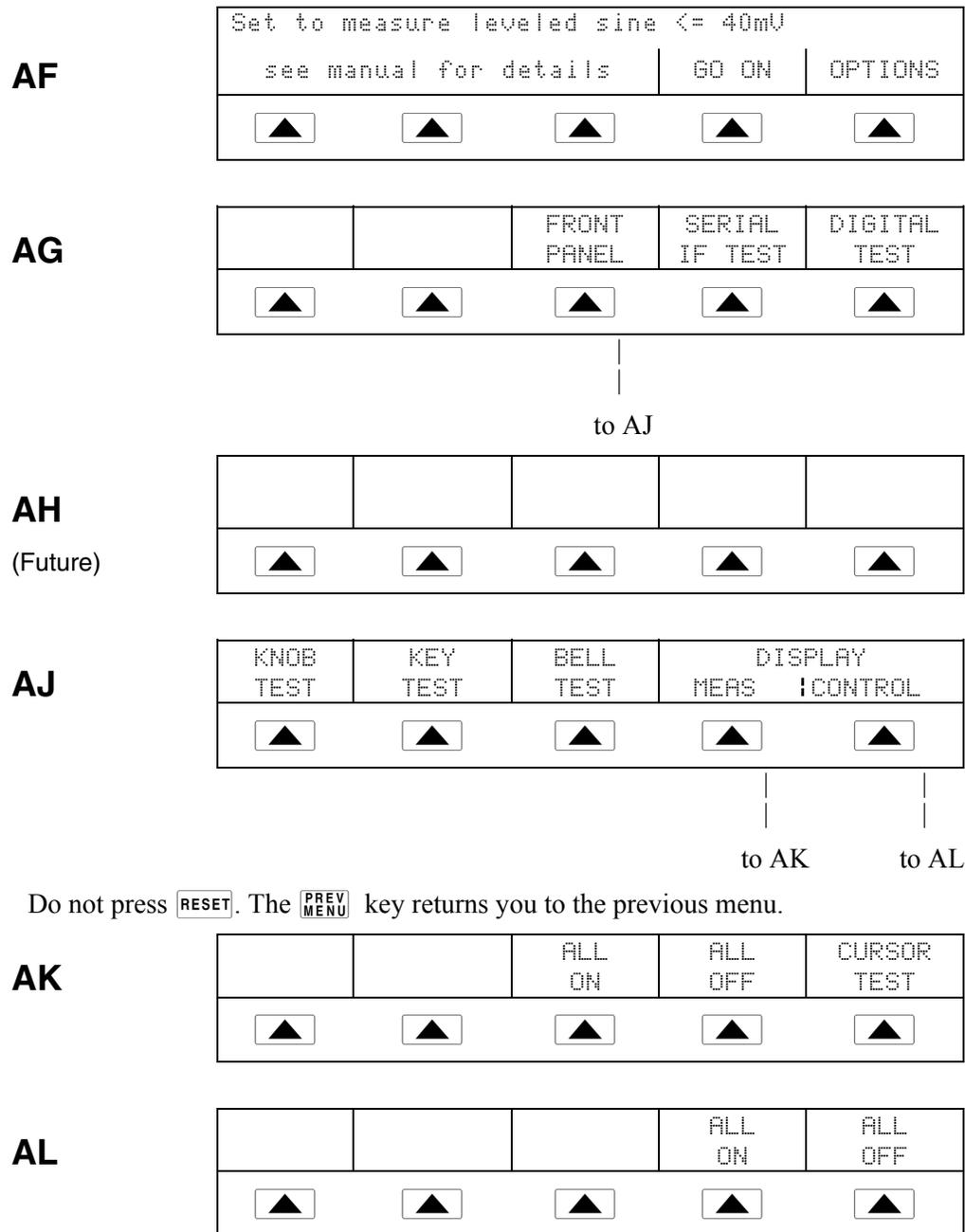

Figure 3-4. SETUP Softkey Menu Displays (cont.)

Table 3-3. Factory Default Settings for the SETUP Menu

Features			
Host Connection	GPIB (IEEE-488)	Display Brightness*	level 1,0
GPIB Port Address	4	EOL (end of line)	CRLF
Serial Ports	8 bits, 1 stop bit, xon/xoff, parity none, 9600 baud, wait 30 sec.	Remote I/F	term
Remote commands (see Chapter 6)			
SRQSTR	SRQ: %02x %02x %04x %04x	*PUD string	cleared
* Output Display and Control Display, respectively. There are 8 levels: 0,1,2,3,4,5,6,7.			

Chapter 4

Front Panel Operation

	Title	Page
4-1.	Introduction.....	4-3
4-2.	Turning on the Calibrator	4-3
4-3.	Warming up the Calibrator	4-4
4-4.	Using the Softkeys	4-4
4-5.	Using the Setup Menu.....	4-4
4-6.	Using the Instrument Setup Menu	4-5
4-7.	Utility Functions Menu.....	4-5
4-8.	Using the Format EEPROM Menu	4-6
4-9.	Resetting the Calibrator	4-7
4-10.	Using the Operate and Standby Modes.....	4-7
4-11.	Connecting the Calibrator to the UUT.....	4-7
4-12.	Starting the Calibrator.....	4-8
4-13.	The Output Signal	4-8
4-14.	Editing and Error Output Settings	4-8
4-15.	Adjusting the Output Signal	4-9
4-16.	Keying in a Value	4-9
4-17.	Adjusting Values with the Rotary Knob	4-10
4-18.	Using $\left[\frac{MULT}{X} \right]$ and $\left[\frac{DIV}{\pm} \right]$	4-11
4-19.	Displaying the Output Error	4-11
4-20.	Resetting the Calibrator.....	4-11
4-21.	Calibrating the Voltage Amplitude on an Oscilloscope.....	4-11
4-22.	The VOLTAGE Function.....	4-12
4-23.	The V/DIV Menu	4-13
4-24.	Shortcuts for Setting the Voltage Amplitude	4-13
4-25.	The TRIG (Trigger) Menu.....	4-14
4-26.	Oscilloscope Amplitude Calibration Procedure	4-14
4-27.	Calibrating the Pulse and Frequency Response on an Oscilloscope.....	4-15
4-28.	The Edge Function	4-15
4-29.	The TRIG (Trigger) Menu.....	4-16
4-30.	Oscilloscope Pulse Response Calibration Procedure	4-17
4-31.	Pulse Response Calibration Using a Tunnel Diode Pulser.....	4-18
4-32.	The Leveled Sine Wave Function	4-19
4-33.	Shortcuts for Setting the Frequency and Voltage.....	4-21
4-34.	The MORE OPTIONS Menu	4-21
4-35.	Sweeping Through a Frequency Range.....	4-22

4-36.	Oscilloscope Frequency Response Calibration Procedure	4-23
4-37.	Calibrating the Time Base of an Oscilloscope.....	4-24
4-38.	The Time Marker.....	4-25
4-39.	The TRIG (Trigger) Menu.....	4-26
4-40.	Time Base Marker Calibration Procedure for an Oscilloscope	4-26
4-41.	Testing the Trigger.....	4-27
4-42.	Testing Video Triggers	4-29
4-43.	Verifying Pulse Capture.....	4-30
4-44.	The TRIG (Trigger) Menu.....	4-31
4-45.	Measuring the DC Calibration Output of an Oscilloscope	4-32
4-46.	Measuring Input Impedance and Capacitance	4-32
4-47.	Input Impedance Measurement	4-33
4-48.	Input Capacitance Measurement	4-33
4-49.	Testing Overload Protection	4-34
4-50.	Using Auxiliary Input (AUXIN).....	4-35
4-51.	Setting the Output Channel.....	4-36
4-52.	Using an External Reference	4-36
4-53.	Using the Current Output Function	4-36

4-1. Introduction

Warning

To avoid electric shock, do not make connections to the output terminals when any voltage is present. The 5820A Calibrator is capable of supplying lethal voltages. Placing the instrument in standby may not be enough to avoid shock hazard, since the operate key could be pressed accidentally. Press the reset key and verify that the 5820A Calibrator is in standby before making connections to the output terminals.

This chapter presents instructions for operating the 5820A Calibrator from the front panel. For a description of front panel controls, displays, and terminals, see Chapter 3 for more information.

4-2. Turning on the Calibrator

Warning

To avoid electric shock, make sure the 5820A Calibrator is safely grounded as described in Chapter 2.

Caution

To avoid damage to the Calibrator, before turning the 5820A Calibrator on, make sure that the line voltage selection is set properly. Refer to Chapter 2 to check the line voltage setting.

When you power up the 5820A Calibrator, the initial display is “Starting Up...” (see below) and it completes a self-test routine. If a self-test fails, the Control Display identifies an error code. For a description of error codes, see Chapter 7 for more information.

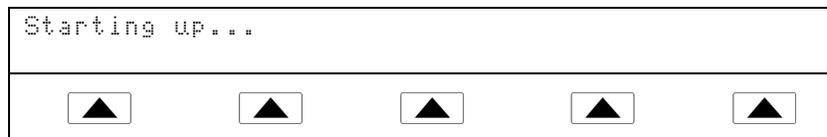

After self-test, the Control Display shows the default condition (below).

CHANGE to DC	SCOPE Z 1 MΩ	V/DIV MENU	TRIG off	MODE volt
				

4-3. Warming up the Calibrator

When you turn on the 5820A, allow a warm-up period of at least 30 minutes for the internal components to stabilize. This ensures that the calibrator meets or exceeds the specifications listed in Chapter 1.

If you turn the 5820A Calibrator off after warm-up and then on again, allow a warm-up period of at least twice the length of time it was turned off (maximum of 30 minutes). For example, if the calibrator is turned off for 10 minutes and then on again, allow a warm-up period of at least 20 minutes.

4-4. Using the Softkeys

The five keys just to the right of the **PREV MENU** (Previous Menu) key are called softkeys. Softkey key functions appear directly above the key in the Control Display. Pressing a softkey either changes a value or causes a submenu with new selections to appear on the Control Display. Softkey menus are arranged in varying levels, as described in Chapter 3. You can move backwards to previous menu selections by repeatedly pressing **PREV MENU**. Although pressing **RESET** also returns you to the top level menu, it also resets all volatile settings and return the Calibrator to the voltage mode. Use the **PREV MENU** key and the mode keys (**VOLTAGE**, etc.) as your main navigating tool for moving around the menu levels.

4-5. Using the Setup Menu

Press the front panel **SETUP** key for access to various operations and changeable parameters. Some parameters are volatile, meaning they will be lost during reset or when power is turned off. The following descriptions indicates which parameters are “nonvolatile.”

When you press **SETUP** from the power-up state, the display changes as follows:

		CAL	INSTMT SETUP	UTILITY FUNCTNS
				

This is the primary instrument setup menu. The list below describes submenus available through each softkey and tells you where you can find further information in the manuals.

- **CAL** (Calibration) Opens the calibration menu. Softkeys in this menu activate calibration to external standards and calibration check. Another softkey displays calibration date information and another opens a calibration report menu.
- **INSTMT SETUP** (Instrument Setup) Selects the desired temperature standard and opens submenus to access Output, Display, and Remote Setups.
- **UTILITY FUNCTNS** (Utility Functions) Allows you to initiate a self-test, format the nonvolatile memory, and review the instrument configuration software versions and user report string. Refer to “Utilities Function Menu” for an explanation of these features.

4-6. Using the Instrument Setup Menu

Refer to the softkeys in the instrument setup menu (accessed by pressing INSTMT SETUP softkey in the Setup Menu) shown below.

		OTHER SETUP	DISPLAY SETUP	REMOTE SETUP
				

The list below describes submenus accessed by each softkey.

- **OTHER SETUP** Opens the Other Setup menu to set the clock and other miscellaneous parameters.
- **DISPLAY SETUP** Opens submenus to set the brightness and contrast of both the Control Display and Output Display.
- **REMOTE SETUP** Allows you to change the configuration of the two RS-232 ports, SERIAL 1 FROM HOST and SERIAL 2 TO UUT, and IEEE-488 General Purpose Interface Bus (GPIB). (See Chapter 5 for more information.)

4-7. Utility Functions Menu

The Setup Menu softkey labeled UTILITY FUNCTNS (Utility Functions) provides access to Self Test, Format Nonvolatile Memory, and Instrument Configuration.

		SELF TEST	FORMAT NV MEM	INSTMT CONFIG
				

- **SELF TEST** This softkey gives access to several calibrator selftests.
- **FORMAT NV MEM** (Format Nonvolatile Memory) Opens a menu to restore all or part of the data in the nonvolatile memory (EEPROM) to factory defaults.
- **INSTMT CONFIG** (Instrument Configuration) Allows you to view the versions of software installed in the calibrator as well as the user-entered report string.

4-8. Using the Format EEPROM Menu

⚠ Caution

To avoid losing calibration constants, use with extreme care. The format nonvolatile memory menu softkeys permanently erase calibration constants. Pressing ALL or CAL invalidates the state of calibration of the 5820A.

Pressing FORMAT NV MEM in the utility functions menu opens the following:



All the softkeys in this menu require the rear panel CALIBRATION switch to be in the ENABLE position. The nonvolatile memory contains calibration constants and dates, setup parameters, and the user report string. In the case of calibration constants, factory defaults are the same for all Calibrators. They are not the calibration constants obtained when the 5820A was calibrated by the factory before shipment. The softkeys are:

- **ALL** Replaces the entire contents of the EEPROM with factory defaults. This would be used by service personnel after replacing the EEPROM, for example. It is not required in normal use.
- **CAL** Replaces all calibration constants with factory defaults but leaves all the setup parameters unchanged. This is also not required in normal use.
- **SETUP** Replaces the setup parameters with factory defaults (Table 4-1) but leaves the state of calibration unchanged. You do not have to break the calibration sticker for this operation. Note that remote commands can change the setup parameters. (See these commands in Chapter 6: SRQSTR, SPLSTR, *PUD, SP_SET, UUT_SET.)

Table 4-1. Factory Defaults for SETUP

Features			
Host Connection	gpib (IEEE-488)	Display Brightness*	level 1,0
GPIB Port Address	4	EOL (end of line)	CRLF
Serial Ports	8 bits, 1 stop bit, xon/xoff, parity none, 9600 baud, wait 30 sec.	Remote I/F	term
Remote commands (see Chapter 6)			
SRQSTR	SRQ: %02x %02x %04x %04x	*PUD string	cleared
* Output Display and Control Display, respectively. There are 8 levels: 0,1,2,3,4,5,6,7.			

4-9. Resetting the Calibrator

At any time during front panel operation (not remote operation), you can return the 5820A Calibrator to the power-up state by pressing **RESET**. Pressing the **RESET** key returns the calibrator to the power-up state: 20 mV, 1 kHz standby, 1 M Ω scope impedances, and returns all other mode settings to their defaults.

4-10. Using the Operate and Standby Modes

When OPR displays in the Output Display, the output value and function shown is active at the selected terminals. When SBY displays in the Output Display, all calibrator outputs are open-circuited. To enable the operate mode or put the calibrator into standby, press



4-11. Connecting the Calibrator to the UUT

Using the cable supplied, connect the Calibrator to the channel connectors on your oscilloscope (see Figure 4-1). If you have a 5-channel Calibrator, you can connect the Calibrator using any of the 5 channels available.

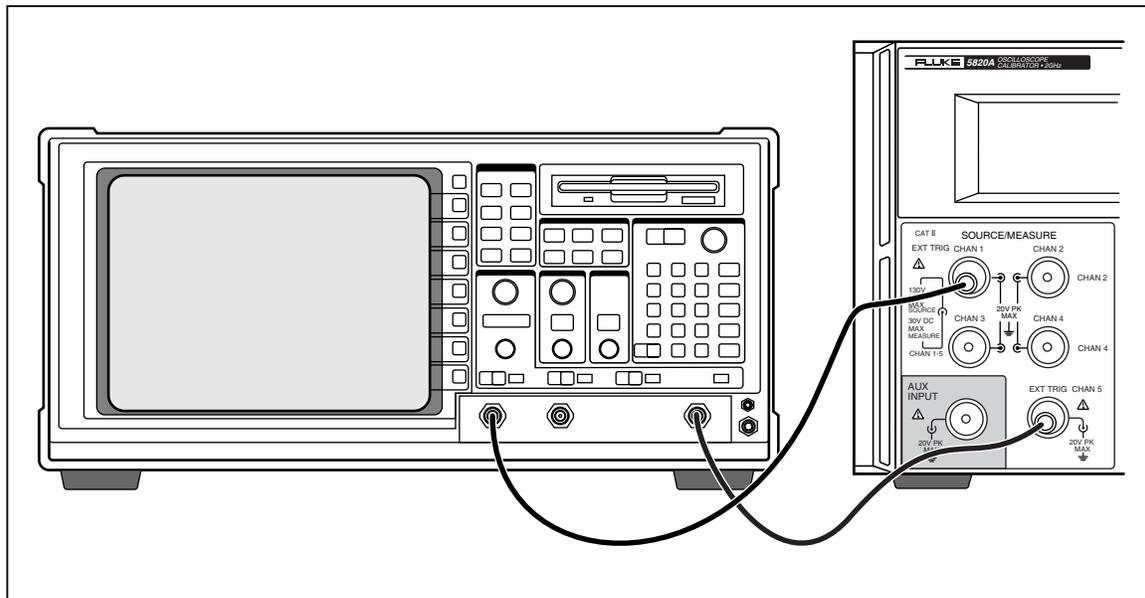

Figure 4-1. Oscilloscope Connection: Channel and External Trigger

yh040f.eps

4-12. Starting the Calibrator

Press the Power button to start the Calibrator. The menu, shown below, defaults to the VOLTAGE menu in the Control Display. You can press the first four keys to go directly to the VOLTAGE, EDGE, LEVEL SINE, and MARKER calibration menus. Press the MORE MODES key to view the other selections (also shown below), allowing access to WAVEGEN, VIDEO, PULSE, MEAS Z (Impedance/Capacitance measurement), and OVERLD (Overload) menus. Press the AUX INPUT key to put the 5820A into auxiliary input mode. Press  to return to the VOLTAGE menu from the OTHER menu. This chapter describes each of these menus in detail.

CHANGE to DC	SCOPE Z 1 MΩ	V/DIV MENU	TRIG off	MODE volt
				

4-13. The Output Signal

The following description assumes that the Voltage mode is on. The Control Display appears as follows:

CHANGE to DC	SCOPE Z 1 MΩ	V/DIV MENU	TRIG off	MODE volt
				

The Control Display (the display on the right side) indicates the location of the output signal. If you connected your Calibrator, but the output does not appear on the oscilloscope, the Calibrator may be in standby mode. The Output Display (the display on the left side) indicates settings for the output signal.

If SBY is displayed, press . The Output Display shows OPR and the output should appear on the oscilloscope.

4-14. Editing and Error Output Settings

Note

When you use the Edit mode, a new reference point must be available. Because Voltage and Marker modes are the only two modes that create new reference points, Edit works only in those two modes.

All 5820A Calibrator outputs can be edited using the front panel Edit Field knob and associated , , and  keys. The difference between the original output (reference) and edited output is displayed as an “error” between the two settings. This allows you to edit a value to achieve a correct reading at the UUT and thereby calculate an error in $\pm\%$ or ppm (parts per million) if it is less than ± 1000 ppm. Table 4-2 lists the actions that cause the calibrator to exit the error mode and return to the original reference output, or to output a new reference, as selected.

Table 4-2. Keys That Exit Error Mode

Keys	Action
<p style="text-align: center;">ENTER</p> <p style="text-align: center;">+/- + ENTER</p> <p>A new keypad entry + ENTER</p> <p style="text-align: center;">NEW REF</p> <p style="text-align: center;">MULT X</p> <p style="text-align: center;">DIV +</p> <p style="text-align: center;">RESET</p>	<p>Returns to the previous reference value.</p> <p>Inverts the output polarity in Voltage mode.</p> <p>Changes the output.</p> <p>Establishes the present output as a new reference.</p> <p>Sets the calibrator to the next higher cardinal point.</p> <p>Sets the calibrator to the next lower cardinal point.</p> <p>Returns to the power-up state.</p>

4-15. Adjusting the Output Signal

The Calibrator provides several ways to change the settings for the output signal during calibration. Since oscilloscope calibration requires many adjustments of the output signal, the three available methods for changing these settings for oscilloscope calibration are summarized below. These methods provide the means of jumping to a new value or sweeping through a range of values.

4-16. Keying in a Value

The following example is for use in the Voltage mode. To key a specific value directly into the Calibrator from its front panel:

1. Key in the value you want to enter, including the units and prefixes. For example, to enter 120 mV, press **1** **2** **0** **m** **V**. The Control Display shows:

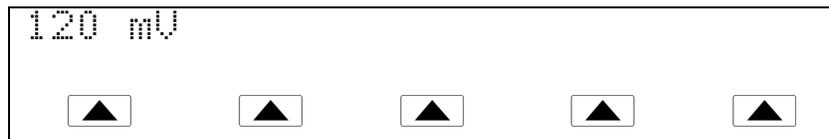

If you make an error, press **CE** to clear the Control Display and return to the menu.

2. Press **ENTER** to activate the value and move it to the Output Display.

Other settings in the display remains unaltered unless you key in an entry and specify the units for that setting.

4-17. Adjusting Values with the Rotary Knob

To adjust values in the Output Display using the rotary knob:

1. Turn the rotary knob. A cursor appears in the Output Display under the lowest digit and begins changing that digit. If you wish to place the cursor in the field without changing the digit, press **EDIT FIELD**.

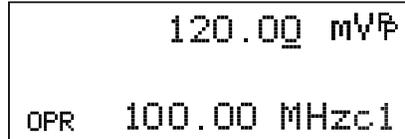

```

      120.00 mVp
OPR  100.00 MHzc1
  
```

oq010f.eps

2. To move the cursor between the voltage and frequency fields, press **EDIT FIELD**.

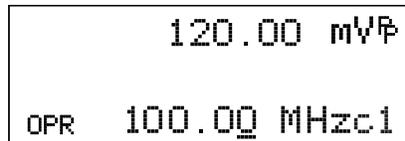

```

      120.00 mVp
OPR  100.00 MHzc1
  
```

oq011f.eps

3. Use the **◀** and **▶** keys to move the cursor to the digit you want to change.
4. Turn the rotary knob to change the value.

When you use the rotary knob in either Voltage mode or Marker mode, the Control Display shows the new value's percentage change from the reference value. This is useful for determining the percentage of error on the oscilloscope. You can set the reference value to the new value by pressing **NEW REF**.

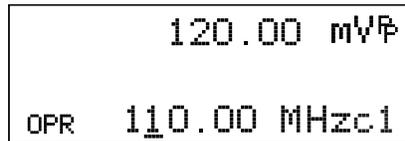

```

      120.00 mVp
OPR  110.00 MHzc1
  
```

oq012f.eps

5. Press **ENTER** to remove the cursor from the Output Display and save the new value as the reference value.

Note

If you attempt to use the rotary knob to adjust a value to an amount that is invalid for the function you are using, or is outside the value's range limit, the value will not change and the Calibrator will beep.

4-18. Using MULT_X and DIV_±

The MULT_X and DIV_± keys cause the current value of the signal to jump to a pre-determined cardinal value, whose amount is determined by the current function. These keys are described in more detail under the descriptions for each function.

4-19. Displaying the Output Error

When you edit the output value in the Voltage or Marker mode, the Control Display shows the difference between the reference value (the value you originally entered) and the edit value (the value shown in the Output Display), displaying error difference in parts per million (ppm). This allows you to edit the output such that the UUT displays the expected value and thus give an indication of the UUT accuracy.



For example, an edited difference of .00030 volts for an output of 10.00000 V represents $0.00030/10.00000 = 0.000030$, or 30 parts per million. The sign is negative (-30.0 ppm) because the output necessary to display 10.00000 at the UUT shows the UUT is reading below the output value. When the reference is negative, the error sign is relative to the magnitude. For example, if the reference is -10.00000V and the output display is -10.00030, the error is -30 ppm.

4-20. Resetting the Calibrator

You can reset all parameters in the Calibrator to their default settings at any time during front panel operations by pressing the RESET key on the front panel.

After resetting the Calibrator, press OPR
STBY to reconnect the signal output.

4-21. Calibrating the Voltage Amplitude on an Oscilloscope

Calibrate the oscilloscope voltage (vertical) gain by applying a dc or low frequency square wave signal and adjusting its gain to meet the height specified for different voltage levels, as designated by the graticule line divisions on the oscilloscope. The applied signal from the Calibrator is in Voltage mode. The specific voltages that you should use for calibration, and the graticule line divisions that need to be matched, vary for different oscilloscopes and are specified in your oscilloscope's service manual.

4-22. The VOLTAGE Function

You can calibrate the Voltage gain using the VOLTAGE function. To access the VOLTAGE menu, press **VOLTAGE** or press the softkey under MODE until “volt” appears.

CHANGE to DC	SCOPE Z 1 M Ω	V/DIV MENU	TRIG off	MODE volt
				
DC<-AC DC->AC	1 M Ω 50 Ω	(see “The V/DIV Menu”)	off /1	volt edge levsine marker wavegen video pulse meas Z overld auxin

The following describes each menu item:

- **DC<-AC** Toggles from ac to dc, producing the dc equivalent output. **DC->AC** Toggles from dc to ac (1 kHz).
- **1 M Ω** Toggles between 1 M Ω and 50 Ω to match the input impedance of the oscilloscope.
- **V/DIV MENU** Opens the voltage scaling menu, which lets you select the signal amplitude in volts per division. For more details, refer to “V/DIV Menu” described below.
- **TRIG** If you are using square wave to calibrate the external trigger, use this key to toggle the trigger off and on. When on, the reading shows “/1”, which indicates that the external trigger is at the same frequency as the volt output. If you have the 5-channel option, you must select which connector to use for the external trigger and the channel connector for the output. For details, refer to “The TRIG (Trigger) Menu” later in this chapter. The external trigger can be useful for many oscilloscopes that have difficulty triggering on low amplitude signals. You can also toggle the trigger off.
- **MODE** Indicates you are in “volt” mode. Use the softkey to change modes as an alternative to the dedicated MODE keys.

4-23. The V/DIV Menu

The V/DIV menu, shown below, sets the number of volts denoted by each division on the oscilloscope. This menu provides alternative methods for changing the output amplitude that may be more convenient for certain oscilloscope applications. To access the V/DIV menu, press V/DIV from the VOLTAGE menu.

20.00 mV/div		#DIV = 1		MODE
up	down	up	down	volt
▲	▲	▲	▲	▲
-----		-----		
1 mV	0.5V	1		volt
2 mV	1V	2		edge
5 mV	2V	3		levsine
10 mV	5V	4		marker
20 mV	10V	5		wavegen
50 mV	20V	6		video
100 mV	50V	7		pulse
200 mV	100V	8		meas Z
				overld
				auxin

The following describes each item in the V/DIV menu:

- **V/div** Changes the number of volts per division in the Output Display so that the values selected correspond to the oscilloscope's input sensitivity (VOLTS/DIV.) The available settings, shown in the figure above, are provided in 1-2-5 step increments. Press the softkey under UP to increase the volts per division. Press the softkey under DOWN to decrease the volts per division.
- **#DIV** Specifies the number of divisions that establish the peak-to-peak value of the waveform. The value can be adjusted from one to eight divisions. The amount denoted by each division is displayed in the V/div field. Press the softkey under UP to increase the signal's height, and press the softkey under DOWN to decrease it.

4-24. Shortcuts for Setting the Voltage Amplitude

The **MULT** and **DIV** keys step the voltages through cardinal point values of an oscilloscope in a 1-2-5 step sequence. For example, if the voltage is 40 mV, pressing **MULT** increases the voltage to the nearest cardinal point, which is 50 mV. Pressing **DIV** decreases the voltage to the nearest cardinal point, which is 20 mV.

4-25. The TRIG (Trigger) Menu

The TRIG menu shown below allows you to set the external trigger to either Channel 1 or Channel 5 and select the number of divisions that establish the peak to peak value of the wave form.

	TRIG CH	TIMEDIV	MODE
	5	off	edge
▲	▲	▲	▲
	5	off	
	1	/1	

If you have the 5-channel option, the following describes each item in the TRIG menu:

- **TRIG CH** Allows you to select either Channel 5 (C5) or Channel 1 (C1) as the external trigger channel, with C5 being the default. When you select one channel as an external trigger, the other channel becomes a source.
- **TIMEDIV** Allows you to select the trigger settings, with "off" being the default. When the trigger is on, the instrument does not allow the signal output and trigger output to be on the same output. If you change the external trigger from C5 to C1 and select a trigger setting other than "off," the Calibrator automatically changes the source from C1 to C2. This change prevents a conflict between the external trigger and the source.

If you change the external trigger from C1 to C5 and select a trigger setting other than "off," the Calibrator automatically changes the source from C5 to C1.

4-26. Oscilloscope Amplitude Calibration Procedure

The following example describes how to use the VOLTAGE menu to calibrate the oscilloscope's amplitude gain. During calibration, you need to set different voltages and verify that the gain matches the graticule lines on the oscilloscope according to the specifications for your particular oscilloscope. See your oscilloscope manual for the recommended calibration settings and appropriate gain values.

CHANGE	SCOPE Z	V/DIV	TRIG	MODE
to DC	1 MΩ	MENU	off	volt
▲	▲	▲	▲	▲

Perform the following sample procedure to calibrate the vertical gain:

1. Connect the calibrator to Channel 1 on the oscilloscope, making sure the oscilloscope is terminated at the proper impedance (1 MΩ for this example). Verify that OPR appears in the Output Display, indicating that the signal is connected.
2. Key in the voltage level that is recommended for your oscilloscope. For example to enter 30 mV, press **3** **0** **m** **V**, then press **ENTER**..See "Keying in a Value" earlier in this chapter.

3. Adjust the oscilloscope as necessary. The waveform should be similar to the one shown below, with the gain at exactly the amount specified for the calibration settings for your oscilloscope. This example shows the gain at 30 mV to be 6 divisions, at 5 mV per division.

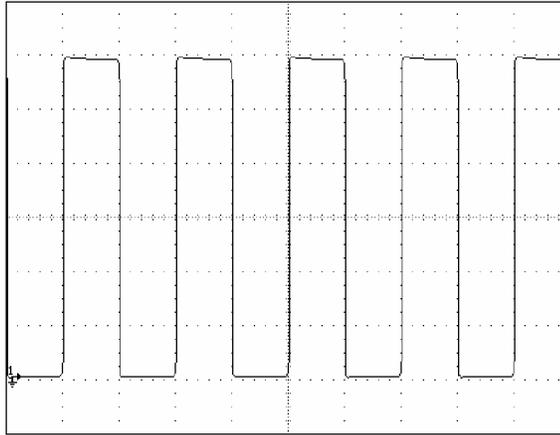

oq015f.bmp

4. Change the voltage to the next value recommended for calibrating your oscilloscope model, and repeat this procedure at the new voltage level, verifying the gain is correct according to the specifications in your manual.
5. Repeat the procedure for each channel.

4-27. Calibrating the Pulse and Frequency Response on an Oscilloscope

Calibrate the pulse response with a square-wave signal that has a fast leading edge rise-time. Using this signal, you adjust the oscilloscope as necessary until it meets its particular specifications for rise time and pulse aberrations.

Following pulse verification, check the frequency response by applying a leveled sine wave and acquiring a frequency reading at the -3 dB point, when the amplitude drops approximately 30 %.

4-28. The Edge Function

Use the EDGE function for calibrating the pulse response for your oscilloscope. To access the EDGE menu, press **EDGE** or press the softkey under MODE until “edge” appears.

		TDPULSE off	TRIG off	MODE edge
▲	▲	▲	▲	▲
		off on	off /1	volt edge levsine marker wavegen video pulse meas Z overld auxin

The following describes each option in the EDGE menu:

You cannot change the output impedance in EDGE function.

- **TD PULSE** Press once to turn the Tunnel Diode Pulser drive signal on, again to turn the Pulser drive off. This signal sources up to 100 V p-p to drive a Tunnel Diode Pulser (Fluke Part Number 606522 or equivalent.)
- **TRIG** If you are using the external trigger, use this key to toggle the trigger off and on. When on, the reading will show “/1” which indicates that the external trigger is at the same frequency as the edge output. If you have the 5-channel option, you must select which connector to use for the external trigger and the channel connector for the output. For details, refer to “The TRIG (Trigger) Menu” below. The external trigger can be useful for many oscilloscopes that have difficulty triggering on low amplitude signals.
- **MODE** Indicates you are in “edge” mode. Use the softkey to change modes and open menus for other oscilloscope calibration modes.

4-29. The TRIG (Trigger) Menu

The TRIG menu shown below allows you to set the external trigger to either Channel 1 or Channel 5.

		TRIG CH 5	TIMEDIV off	MODE edge
▲	▲	▲	▲	▲
	5 1	off /1		

If you have the 5-channel option, the following describes each item in the TRIG menu:

- **TRIG CH** Allows you to select either Channel 5 (C5) or Channel 1 (C1) as the external trigger channel, with C5 being the default. When you select one channel as an external trigger, the other channel becomes a source.
- **TIMEDIV** Allows you to select the trigger settings, with "off" being the default. When the trigger is on, the instrument does not allow the signal output and trigger output to be on the same output. If you change the external trigger from C5 to C1 and select a trigger setting other than "off," the Calibrator automatically changes the source from C1 to C2. This change prevents a conflict between the external trigger and the source.

If you change the external trigger from C1 to C5 and select a trigger setting other than "off," the Calibrator automatically changes the source from C5 to C1.

4-30. Oscilloscope Pulse Response Calibration Procedure

This sample procedure shows how to check the oscilloscope's pulse response. Before you check your oscilloscope, see your oscilloscope's manual for the recommended calibration settings.

Before you start this procedure, verify that you are in Edge mode. If you are, the Control Display shows the following menu:

	TDPULSE off	TRIG off	MODE edge
▲	▲	▲	▲

Perform the following sample procedure to calibrate the pulse response:

1. Connect the Calibrator to Channel 1 on the oscilloscope. Select 50 Ω impedance or use a 50 Ω termination directly at the oscilloscope input. Verify that OPR appears in the Output Display, indicating that the signal is connected.
2. Alter the voltage setting for the signal so it matches the amplitude value recommended by your oscilloscope manufacturer for calibrating the edge response. The default setting is 25.00 mV p-p, 1.0000 MHz.

For example, on an HP 54522C oscilloscope, start with a signal of 1 V @ 1 MHz.

3. Adjust the scale on your oscilloscope to achieve a good picture of the edge.
4. Adjust the time base on your oscilloscope to the fastest position available (≤ 1 ns/div).

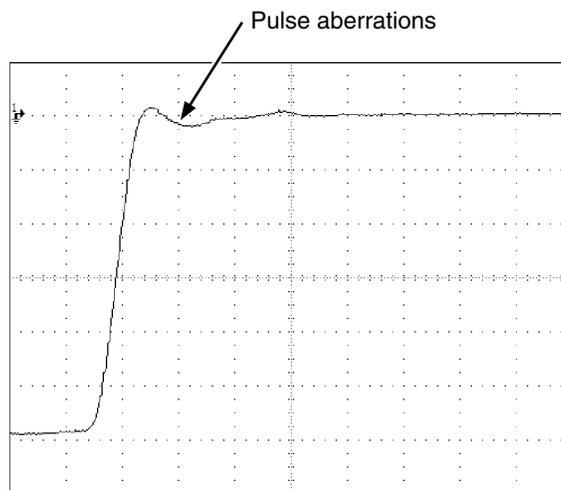

oq013c.eps

5. Verify that your oscilloscope exhibits the proper rise time and pulse aberration characteristics.
6. Remove the input signal by pressing .

4-31. Pulse Response Calibration Using a Tunnel Diode Pulser

You can use the calibrator to drive a tunnel diode pulser (Fluke Part Number 606522 or equivalent), allowing you to check for pulse edge rise times as fast as 125 ps.

The calibrator sources a maximum pulser drive signal of 100 V p-p at 100 kHz. The recommended (and default) output setting is 80 V p-p at 100 kHz.

Perform the following procedure to use a tunnel diode pulser:

1. Connect the calibrator, tunnel diode pulser, and oscilloscope as shown in Figure 4-2.
2. In Edge mode, press the TDPULSE softkey to “on”.
3. Press .
4. Rotate the control on the pulser box to the minimum setting necessary to trigger a reading.

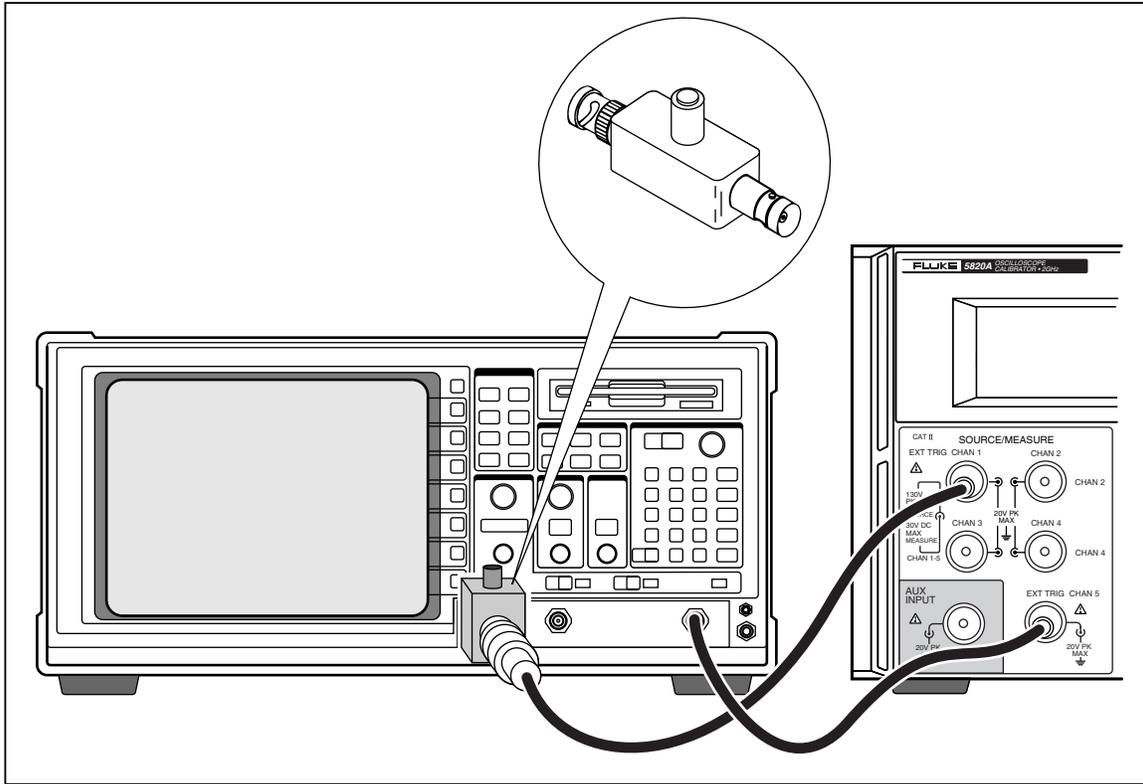

Figure 4-2. Tunnel Diode Pulser Connections

yh041f.eps

4-32. The Leveled Sine Wave Function

The Leveled Sine Wave (LEVEL SINE) function uses a leveled sine wave, whose amplitude remains relatively constant over a range of frequencies, to check the oscilloscope's bandwidth. When you check your oscilloscope, you change the wave's frequency until the amplitude displayed on the oscilloscope drops 30 %, which is the amplitude that corresponds to the -3 dB point. Default values are 30 mV p-p, 50 kHz.

To access the LEVEL SINE menu, press  or press the softkey under MODE until “levsine” appears.

FREQ CH G jump	RATE 1 MHz	MORE OPTIONS	SET TO LAST F	MODE levsine
				
jump sweep	1 MHz 10 MHz 100 MHz	(see “The MORE OPTIONS Menu”)	LAST F 50 kHz	volt edge levsine marker wavegen video pulse meas Z overld auxin

The following describes each option in the LEVEL SINE menu:

- **FREQ CHG** (Frequency Change) Toggles between two settings that control the way the output signal adjusts to a new frequency. “Jump” is the default setting.

“Jump” causes the output signal to jump immediately to a new frequency setting.

“Sweep” causes the signal to sweep through a series of frequency values, over a range you set. Use the sweep function to watch the signal gradually change over a given bandwidth and see the point at which its amplitude changes. Details for using the sweep function are provided under “Sweeping Through a Frequency Range.”

- **RATE** Use when you set FREQ CHG to “sweep” to select a sweep speed of 100 kHz, 1 MHz, or 10 MHz.

A slower sweep rate lets you watch the frequency change very slowly. After a faster sweep, you may want to pinpoint a certain frequency with a slower sweep over a subset of your previous frequency range.

- **MORE OPTIONS** Opens additional menu items, which are described in detail under “The MORE OPTIONS Menu.”
- **SET TO LAST F** Toggles between the current frequency setting and the reference value of 50 kHz. This option allows you to revert to the reference to check the output after you make adjustments at another frequency.
- **MODE** Indicates you are in “levsine” mode. Use the softkey to change modes and open menus for other calibration modes.

4-33. Shortcuts for Setting the Frequency and Voltage

The following three options allow you to control the sine wave settings:

- **SET TO LAST F** toggles between the last frequency used and the reference frequency of 50 kHz, letting you check the output at the reference after you make adjustments at a different frequency.
- **MORE OPTIONS** lets you lock the voltage range, if necessary. The following section provides details on this menu.
- The $\boxed{\text{MULT}}_{\times}$ and $\boxed{\text{DIV}}_{\div}$ keys step frequencies up or down in amounts that let you quickly access a new set of frequencies. For example, if the value is 250 kHz, $\boxed{\text{MULT}}_{\times}$ changes it to 300 kHz, and $\boxed{\text{DIV}}_{\div}$ changes it to 200 kHz. For voltage values, $\boxed{\text{MULT}}_{\times}$ and $\boxed{\text{DIV}}_{\div}$ step through cardinal point values in a 1.2-3-6 sequence.

4-34. The MORE OPTIONS Menu

When you press the MORE OPTIONS softkey, you open a menu that allows you to see and lock the amplitude range.

	Range = 40 mV auto	MODE levsine	
\blacktriangle	\blacktriangle	\blacktriangle	\blacktriangle
-----		volt	
auto		edge	
locked		levsine	
10 mV		marker	
40 mV		wavegen	
100 mV		video	
400 mV		pulse	
1.3V		meas Z	
5.5V		overld	
		auxin	

The following describes each option in the MORE OPTIONS menu:

- **RANGE** The softkeys toggle between two settings. The first setting (“auto”) changes the range limit automatically in accordance with the voltage level. The second setting (“locked”) freezes the present range limit; subsequent changes in voltage level are then measured with this range limit.

The Level Sine mode has six range limits: 10 mV, 40 mV, 100 mV, 400 mV, 1.3 V, and 5.5 V. When set to “auto” the calibrator uses your voltage setting to automatically set the range limit that provides the most accurate output.

When set to “locked” the range limit remains fixed and you can decrease the voltage down to the bottom of the range.

For example, assume the range limit is 40 mV. If you enter 5 mV with “auto” selected, the calibrator automatically changes the range limit to 10 mV and output 5 mV from within the 10 mV range. However, if you start with the 40 mV range “locked” and then enter 5 mV, the calibrator outputs 5 mV from within the 40 mV range.

The default range setting is “auto,” which should always be used unless you are troubleshooting discontinuities in your oscilloscope’s vertical gain. The range setting always returns to “auto” after you leave Level Sine mode.

- **MODE** Indicates you are in “levsine” mode. Use the softkey to change modes and open menus for other calibration modes.

4-35. Sweeping Through a Frequency Range

When you change frequencies using the sweep method, the output sine wave sweeps through a specified range of frequencies. This feature lets you identify the frequency at which the oscilloscope’s signal exhibits certain behavior; you can quickly see the frequency response of the oscilloscope. Before you start this procedure, make sure you are in the MORE OPTIONS menu and the sine wave is displayed on the oscilloscope.

Perform the following procedure to sweep through frequencies:

1. Make sure the output signal shows the starting frequency. If not, key in the starting frequency; then press .
2. Toggle **FREQ CHG** to “sweep.” Toggle the **RATE** to a lower frequency if you want to observe a very slow sweep over a small range.
3. Key in the end frequency; then press . After you press , the signal sweeps through frequencies between the two values you entered, and the Sweep menu (“Sweeping from previous to displayed frequency”) appears on the Control Display.
4. You can let the signal sweep through the entire range, or you can halt the sweep if you need to record the frequency at a certain point.

To interrupt the sweep, press the softkey under **HALT SWEEP**. The current frequency appears on the Output Display and the MORE OPTIONS menu will reappear on the Control Display.

Note

*When you interrupt the frequency sweep by pressing **HALT SWEEP**, the **FREQ CHG** method switches back to “jump.”*

5. Repeat the procedure if necessary. For example, if you did a fast sweep, you may want to pinpoint a certain frequency with a slow sweep over a subset of your previous frequency range.

4-36. Oscilloscope Frequency Response Calibration Procedure

Perform this sample procedure, which verifies the frequency response on your oscilloscope, after the pulse response verification.

This procedure checks the bandwidth by finding the frequency at the -3 dB point for your oscilloscope. The reference sine wave in this procedure has an amplitude of 6 divisions, so that the -3 dB point can be found when the amplitude drops to 4.2 divisions.

Before you start this example procedure, verify that you are in Level Sine mode. If you are, the Control Display shows the following menu:

FREQ CHG jump	RATE 1 MHz	MORE OPTIONS	SET TO LAST F	MODE levsine
▲	▲	▲	▲	▲

Perform the following sample procedure to calibrate the frequency response:

1. Reconnect the signal by pressing **OPR STBY** on the Calibrator. Select 50 Ω impedance or use a 50 Ω external termination directly at the oscilloscope input.
2. Adjust the sine wave settings in the Output Display according to the calibration recommendations in your oscilloscope manual. For example, for the HP 54522C oscilloscope, start at 600 mV @ 1 MHz. To enter 600 mV, press **6 0 0 m V**; then press **ENTER**.
3. Adjust the oscilloscope as necessary. The sine wave should appear at exactly six divisions, peak-to-peak, as shown below.

If necessary, make small adjustments to the voltage amplitude until the wave reaches exactly six divisions. To fine-tune the voltage, press **EDIT FIELD** to bring a cursor into the Output Display, move the cursor with the **◀** key, and turn the rotary knob to adjust the value. (See “Adjusting Values with the Rotary Knob” earlier in this chapter.)

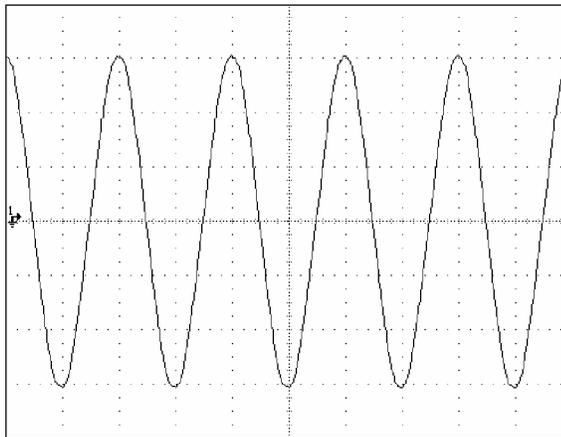

oq016f.bmp

4. Increase the frequency to 400 MHz (for 500-MHz instruments), or 500 MHz (for 600-MHz instruments). To enter 400 MHz, press **4** **0** **0** **M** **Hz**; then press **ENTER**.
5. Continue to increase the frequency slowly until the waveform decreases to 4.2 divisions, as shown below.

To increase the frequency slowly, fine-tune it using the rotary knob. To do this, press **EDIT FIELD** to place a cursor in the Output Display. Press **EDIT FIELD** again to place it in the frequency field, and use the **◀** and **▶** keys to move it to the digit you want to change. Then change the value by turning the rotary knob. Continue making small increments in the frequency until the signal drops to 4.2 divisions. At 4.2 divisions, the signal is at the frequency that corresponds to the -3 dB point.

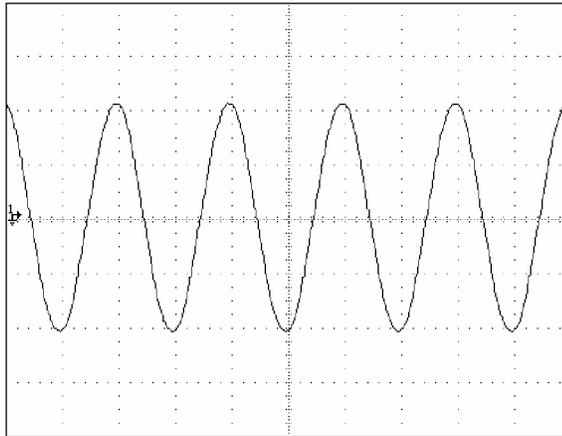

oq017f.bmp

6. Remove the input signal by pressing **OPR STBY**.
7. Repeat this procedure for the remaining channels on your oscilloscope.

4-37. Calibrating the Time Base of an Oscilloscope

Calibrate the horizontal deflection (time base) of an oscilloscope using a method similar to the vertical gain calibration. The Calibrator generates a time marker signal and the signal's peaks are matched to the graticule line divisions on the oscilloscope.

4-38. The Time Marker

The Time MARKER function, which is available through the MARKER menu, lets you calibrate the timing response of your oscilloscope. To access the MARKER menu, press **MARKER** or the softkey under MODE until “marker” appears.

	SHAPE spike	TRIG off	MODE marker
	sine spike square sq20%	off /1 /10 /100	volt edge levsine marker wavegen video pulse meas Z overld auxin

The following describes each option in the MARKER menu:

- **SHAPE** Selects the marker waveform. Depending on frequency setting, possible selections are sine, spike, square (50 % duty cycle square wave), and sq20% (20 % duty cycle square wave.) Note that selections available under SHAPE depend on the selected marker period (frequency), as follows:

Selection	Period (Frequency)
sine	10 ns - 2 ns (100 MHz - 500 MHz)
spike	5s - 20 ns (0.2 Hz - 50 MHz)
square	5s - 10 ns (0.2 Hz - 100 MHz)
sq20%	20 ms - 100 ns (50 kHz - 10 MHz)

- **TRIG** If you are using the external trigger, use this key to cycle through the trigger settings. The available trigger settings are: off, /1 (trigger signal appears on each marker), /10 (trigger signal appears on every tenth marker), and /100 (trigger signal appears at every 100th marker). If you have the 5-channel option, you must select which connector to use for the external trigger and the channel connector for the output.
- **MODE** Indicates you are in “marker” mode. Use the softkey to change modes and open menus for other oscilloscope calibration modes.

Default marker values are 1.000 ms, SHAPE = spike.

The **MULT** and **DIV** keys step the voltages through cardinal point values of an oscilloscope in a 1-2-5 step sequence. For example, if the period is 1.000 ms, pressing **MULT** increases the period to the nearest cardinal point, which is 2.000 ms. Pressing **DIV** decreases the voltage to the nearest cardinal point, which is 500 μs.

4-39. The TRIG (Trigger) Menu

The TRIG menu shown below allows you to set the external trigger to either Channel 1 or Channel 5.

		TRIG CH 5	TIMEDIV off	MODE edge
	5	off		
	1	/1		
		/10		
		/100		

If you have the 5-channel option, the following describes each item in the TRIG menu:

- **TRIG CH** Allows you to select either Channel 5 (C5) or Channel 1 (C1) as the external trigger channel, with C5 being the default. When you select one channel as an external trigger, the other channel becomes a source.
- **TIMEDIV** Allows you to select the trigger settings, with "off" being the default. When the trigger is on, the instrument does not allow the signal output and trigger output to be on the same output. If you change the external trigger from C5 to C1 and select a trigger setting other than "off," the Calibrator automatically changes the source from C1 to C2. This change prevents a conflict between the external trigger and the source.

If you change the external trigger from C1 to C5 and select a trigger setting other than "off," the Calibrator automatically changes the source from C5 to C1.

4-40. Time Base Marker Calibration Procedure for an Oscilloscope

This sample procedure uses the Time MARKER function to check the horizontal deflection (time base) of your oscilloscope. See your oscilloscope's manual for the exact time base values recommended for calibration.

Before you begin this procedure, verify that you are in Marker mode. If you are, the Control Display shows the following menu.

		SHAPE spike	TRIG off	MODE marker

Perform the following sample procedure to calibrate the time base:

1. Connect the calibrator to Channel 1 on the oscilloscope. Select 50 Ω impedance or use an external 50 Ω termination. Make sure the oscilloscope is dc-coupled.
2. Apply a time marker value according to the recommended calibration settings in your oscilloscope manual. For example, to enter 200 ns, press **2** **0** **0** **n** **sec**, then press **ENTER**.

Note

You may enter the equivalent frequency instead of the time marker value. For example, instead of entering 200 ns, you may enter 5 MHz.

3. Set your oscilloscope's time base to show 10 time markers. The time markers should align with the oscilloscope divisions, as shown in the example below.

For an accurate reading, align the signal's peaks with the horizontal center axis.

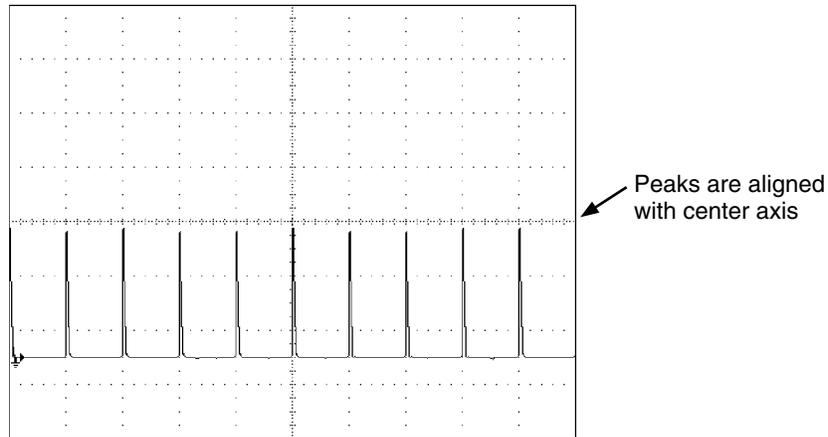

oq014c.eps

4. Repeat this procedure for all time marker values recommended for your oscilloscope. Repeat for digital and analog mode as required. Some oscilloscopes may need the magnification changed while calibrating in analog mode.
5. Remove the signal by pressing .

4-41. Testing the Trigger

The oscilloscope's ability to trigger on different waveforms can be tested using the wave generator. When you use the wave generator, a square, sine, or triangle wave transmits and the wave's output impedance, offset, and voltage can be varied in order to test the triggering capability at different levels.

Note

The wave generator should not be used for checking the accuracy of your oscilloscope.

The wave generator is available through the WAVEGEN menu, shown below. To access this function, press **MORE MODES** and then select “wavegen” or press the softkey under MODE until “wavegen” appears.

	SCOPE Z 1 M Ω	WAVE square	OFFSET +0 V	MODE wavegen
	1 M Ω 50 Ω	square sine tri	0mV 0 V	volt edge levsine marker wavegen video pulse meas Z overld auxin

The following describes each option in the WAVEGEN menu:

- **WAVE** Scrolls through the three types of waveforms that are available. You can select a square, sine, or triangle wave as the output.
- **SCOPE Z** Toggles the calibrator’s output impedance setting between 50 Ω and 1 M Ω .
- **OFFSET** Displays the offset of the generated wave. To change the offset, key in the new value, and press **ENTER**. Using the rotary knob does not change the offset; it changes the actual voltage output.

When you change the offset, you must remain within certain limits to avoid clipping the peaks. The limit depends on the wave’s peak-to-peak value. Specifically, the peak excursion equals the absolute value of the offset plus half of the wave’s peak-to-peak value. See “Wave Generator Specifications” in Chapter 1.

- **MODE** Indicates you are in “wavegen” mode. Use the softkey to change modes and open menus for other oscilloscope calibration modes.

Default WAVEGEN settings are 20 mV p-p, 1000.0 Hz, WAVE = square, and offset = 0.0V.

4-42. Testing Video Triggers

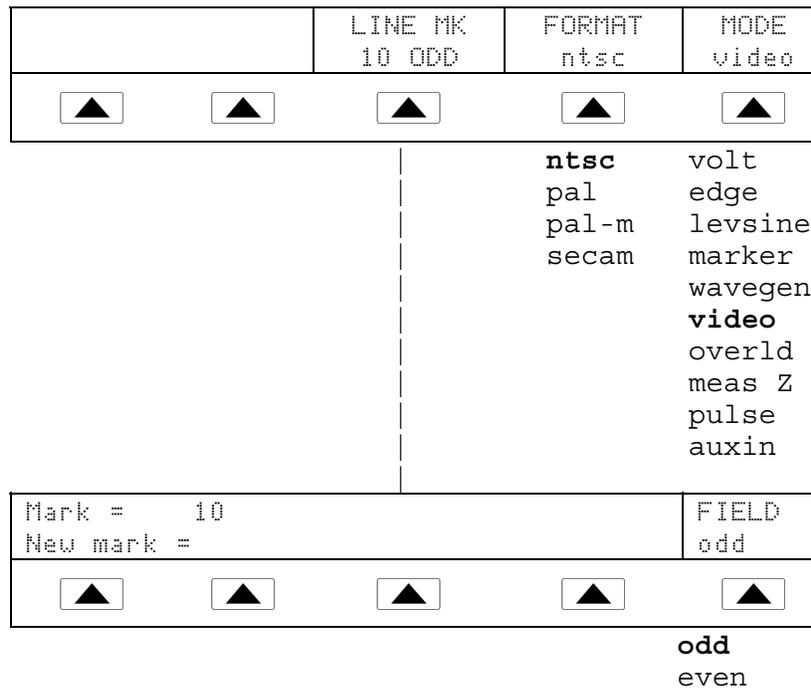

To access the VIDEO menu, press **MORE MODES** and then select VIDEO or press the softkey under MODE until “video” appears.

The following describes each option in the VIDEO menu:

- **LINE MK** Allows you to select the marker line number. For ntsc and pal-m formats, you can also select field (“odd” or “even”). For pal and secam formats, the field (“ODD” or “EVEN”) is selected automatically based on marker line number.
- **FORMAT** Scrolls through the available formats. You can select ntsc, pal, pal-m, and secam.
- **MODE** Indicates the calibrator is in “video” mode. Use the softkey to change modes and open menus for other oscilloscope calibration modes.

Default video settings are + 100 %, format = NTSC, and videomark = 10.

4-43. Verifying Pulse Capture

		AMPL 1.5V	TRIG off	MODE pulse
	▲	▲	▲	▲
		1.5V	off	volt
		600 mV	Trigger Skew	edge
		150 mV	Trig CH x	levsine
		60 mV	TIMEDIV	marker
		15 mV	MODE pulse	wavegen
				video
				pulse
				meas Z
				overld
				auxin

To access the PULSE menu, press **MORE MODES** key and then select PULSE or press the softkey under MODE until “pulse” appears.

The following describes each option in the PULSE menu:

- **AMPL** Indicates the output level. You can change the pulse amplitude by pressing the blue key under the “Ampl” menu item. Each press toggles through the available pulse amplitudes. Max amplitude is 1.5 Vpp.

To change the pulse width, press **EDIT FIELD** once and move the cursor to the pulse width digit you wish to modify. Alternatively, you can enter in the pulse width value directly on the 5820A numeric keypad.

To change the pulse period, press **EDIT FIELD** until the cursor is on the second line of the output display (unlabeled line). Use the cursor and edit wheel to change the value. Note that periods are not always compatible with the pulse width selected. A beep sounds if the pulse period is reduced to too low a value. As an example, the pulse period can not be less than 1 μ s for a pulse width of 25 ns. Alternatively, you can enter the pulse period as a frequency (for example, 1 MHz sets a pulse period of 1 μ s).

To change both the width and period, use the keyboard to enter in the pulse width first immediately followed by the period value. For example,

5 **0** **n** **sec** **1** **μ** **sec** **ENTER** sets a 50 ns pulse width with a 1 μ s period. Next, press **ENTER**. Both values will be entered. Default settings are 100 ns pulse width with a 10 μ s period.

- **TRIG** For skew or external trigger, use this menu item.
 - **TRIGGER SKEW** Trigger skew modifies the relationship of the output trigger (channel 5 default) with the output pulse signal. If positive values are selected, the trigger occurs before the pulse (LEAD). If negative values are selected, the trigger moves after the pulse (LAG).

- **TRIG CH x** This selection is used for the five channel option to determine whether the trigger comes out of channel 1 or channel 5.
- **TIMEDIV** This selection is used to cycle through the settings. “OFF” shuts off the external trigger and disables the skew function. “/1” allows the trigger to appear on every 10th pulse. “/100” allows the trigger to appear on each pulse. “/10” allows the trigger to appear on every 100th pulse. Note that skew only works with the “/1” selection.
- **MODE** Indicates you are in “pulse” mode. Use the softkey to change modes and open menus for other oscilloscope calibration modes.

4-44. The TRIG (Trigger) Menu

The TRIG menu shown below allows you to set the external trigger to either Channel 1 or Channel 5.

	TRIG CH	TIMEDIV	MODE
	5	off	edge
▲	▲	▲	▲
	5	off	
	1	/1	
		/10	
		/100	

If you have the 5-channel option, the following describes each item in the TRIG menu:

- **TRIG CH** Allows you to select either Channel 5 (C5) or Channel 1 (C1) as the external trigger channel, with C5 being the default. When you select one channel as an external trigger, the other channel becomes a source.
- **TIMEDIV** Allows you to select the trigger settings, with ”off” being the default. When the trigger is on, the instrument does not allow the signal output and trigger output to be on the same output. If you change the external trigger from C5 to C1 and select a trigger setting other than “off,” the Calibrator automatically changes the source from C1 to C2. This change prevents a conflict between the external trigger and the source.

If you change the external trigger from C1 to C5 and select a trigger setting other than “off,” the Calibrator automatically changes the source from C5 to C1.

4-45. Measuring the DC Calibration Output of an Oscilloscope

⚠ Caution

Input voltages exceeding 30 VDC may cause damage to the instrument. Do not apply voltages except in voltage measurement mode.

The DC Voltage Measurement function of the 5820A is used to test the DC calibration output of an oscilloscope (such as in the HP Infinium series).

To access the DC Voltage Measurement function, press **MORE MODES** followed by the **OTHER** blue softkey. When the display changes, press the **MEAS V CAL** blue softkey.

Connect the oscilloscope's dc output to CHAN 1 of the 5820A. The 5820A will display the scope's voltage output. Remove the oscilloscope connection when the DC measurement calibration is complete.

4-46. Measuring Input Impedance and Capacitance

	NO OFFSET	MEASURE res 50Ω	MODE meas Z
▲	▲	▲	▲
		res 50Ω	volt
		res 1MΩ	edge
		cap	levsine
			marker
			wavegen
			video
			pulse
			meas Z
			overld
			auxin

To access the meas Z menu, press **MORE MODES** and then select meas z or press the softkey under MODE until “meas Z” appears.

You can press the MODE softkey to cycle through the functions in the order shown, or you can press **PREV MENU** to return directly to the OTHER modes menu.

The following describes each option in the Impedance/Capacitance (meas Z) menu:

- **MEASURE** Indicates the type of test. You can select res 50 Ω or res 1 MΩ termination (for impedance) or cap (capacitance).
- **MODE** Indicates the Calibrator is in “meas Z ” mode. Use the softkey to change modes and open menus for other oscilloscope calibration modes.

If you select Capacitance measurement, the menu appears as follows:

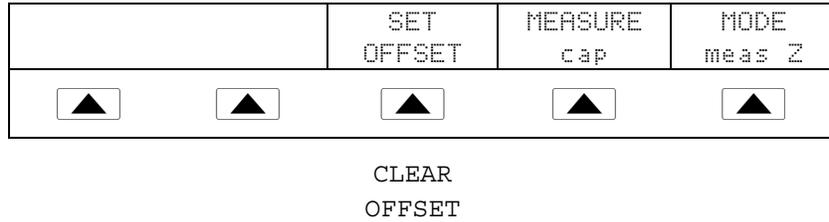

- **SET OFFSET** With the cable disconnected at the oscilloscope but still connected at the Calibrator, press to cancel the capacitance of the Calibrator. Press again to **CLEAR OFFSET** and return to the capacitance reading.
- **NO OFFSET** appears for res 50 Ω and res 1MΩ and the softkey beeps.

Default Impedance Measurement range = 50 ohm.

4-47. Input Impedance Measurement

With Meas Z mode selected, perform the following procedure to measure the input impedance of an oscilloscope:

1. Use the MEASURE softkey to select “res 50Ω“ or “res 1MΩ“ termination.
2. Connect the calibrator to Channel 1 on the oscilloscope.
3. Press OPR
STBY to initiate the measurement.

4-48. Input Capacitance Measurement

With Meas Z mode selected, perform the following procedure to measure the input capacitance of an oscilloscope:

1. Set the oscilloscope for 1 MΩ input impedance. Note that input capacitance testing cannot be done with 50 Ω input impedance.
2. Use the MEASURE softkey to select “cap”.
3. With the output cable connected to the Calibrator but not connected to the oscilloscope, press the SET OFFSET softkey to cancel stray capacitances.
4. Connect the output cable to Channel 1 on the oscilloscope.
5. Press OPR
STBY to initiate the measurement.

4-49. Testing Overload Protection

⚠ Caution

To avoid damage to your oscilloscope, use this test to check the power handling capability of the 50 Ω input of your oscilloscope. Before proceeding, ensure that the power rating of your oscilloscope can handle the voltages and currents that this test can output.

	UUTTRIP in 4.1s	T LIMIT 10s	OUT VAL DC	MODE overld
	▲	▲	▲	▲
			DC AC	volt edge levsine marker wavegen video pulse meas Z overld auxin

To access the OVERLD (overload) menu, press **MORE MODES** key and then select OVERLD or press the softkey under MODE until “overld” appears.

The following describes each option in the OVERLD menu:

- **UUTTRIP** Indicates test results. “NO” appears if the overload protection did not trip within the selected time limit. A value in seconds appears (e.g. “4.1 s”) if the overload protection has tripped within the time limit.
- **T LIMIT** Selects the selected time limit for application of the output value. The 5820A goes to standby either when a UUT trip is detected or the time limit is reached. Press this softkey to key in or edit a different time limit (1 s to 60 s allowed.)
- **OUT VAL** Selects the output voltage type. You can select dc or ac and a value ranging from 5 V to 9 V (shown in Output Display). Key in or edit this value.
- **MODE** Indicates you are in “overld” mode. Use the softkey to change modes and open menus for other oscilloscope calibration modes.

Default overload settings are + 5.000 V and dc.

At any time, you can also set the default overload time limit with the following command sequence:

```

INSTMT  OTHER
SETUP   SETUP   TLIMDEF
[SETUP] [▲]     [▲]     [▲]     (Choose 1s to 60s.)

```

Perform the following procedure to test the overload protection of an oscilloscope:

1. Connect the calibrator to Channel 1 on the oscilloscope.
2. Select the voltage type (dc or ac) using the OUT VAL softkey.
3. Key in the voltage level. (The default value is 5 V.)
4. If necessary, change the duration. (Refer to the procedure described above.) The default duration is 10 s.
5. Check for test results displayed with the UUTTRIP softkey.

4-50. Using Auxiliary Input (AUXIN)

Using an external generator, the AUX INPUT selection allows you to perform bandwidth checks up to 2.4 GHz.

See source instrument for output value.	MODE auxin
<div style="display: flex; justify-content: space-around;"> ▲ ▲ ▲ ▲ ▲ </div>	

volt
 edge
 levsine
 marker
 wavegen
 video
 pulse
 meas Z
 overl d
auxin

To access the AUX INPUT menu, press  or press the softkey under MODE until “auxin” appears.

4-51. Setting the Output Channel

This can be done only with the 5-channel option. This feature allows you to select the output channel. To select a channel, press **CHANNEL**. The following menu appears:



Select the desired menu and press **CHANNEL** again to go back to the original menu.

4-52. Using an External Reference

The calibrator uses an internal 10 MHz clock signal as a reference for all ac functions. Although this internal clock is very accurate and stable, you may have a lab standard that you want to govern the frequency performance of the calibrator. To apply an external clock to the calibrator, you can make external reference the power-up and reset default condition.

To make external reference the power-up and reset default setting, proceed as follows:

1. Connect a 10 MHz squarewave signal of 5 V p-p (maximum) to the EXTERNAL REFERENCE connector.
2. Press **SETUP**.
3. Press the following sequence of softkeys: INSTMT SETUP | OTHER SETUP | REF SETUP.
4. Press the REF CLK softkey to select “external.”
5. Press **PREV MENU**.

4-53. Using the Current Output Function

Access the current output function as follows:

1. Press the **MORE MODES** key followed by the OTHER and CURRENT softkeys. The Control Display shows a label on the right that identifies the mode as “amp.”
2. The leftmost softkey says “DC ONLY.” If an ac current value is desired, press the DC ONLY softkey and enter the desired frequency.
3. Attach the current probe to the current loop located just above the 5800A Calibrator power button.
4. Press **OPR STBY**.
5. To determine the error of the unit under test, turn the knob to activate edit mode.

Chapter 5

Remote Operation

	Title	Page
5-1.	Introduction.....	5-4
5-2.	Setting up the IEEE-488 Port for Remote Control	5-4
5-3.	IEEE-488 Port Setup Procedure	5-7
5-4.	Testing the IEEE-488 Port.....	5-8
5-5.	Setting up the RS-232 Host Port for Remote Control.....	5-11
5-6.	RS-232 Host Port Setup Procedure	5-11
5-7.	Testing the RS-232 Host Port.....	5-13
5-8.	Testing RS-232 Host Port Operation using a Terminal	5-13
5-9.	Testing RS-232 Host Port Operation using Visual Basic	5-15
5-10.	Setting up the RS-232 UUT Port for Remote Control	5-16
5-11.	RS-232 UUT Port Setup Procedure.....	5-16
5-12.	Testing the RS-232 UUT Port via RS-232 Host Port.....	5-17
5-13.	Testing RS-232 UUT Port Operation via a Terminal.....	5-19
5-14.	Testing RS-232 UUT Port Operation using Visual Basic.....	5-20
5-15.	Testing the RS-232 UUT Port via IEEE-488 Port.....	5-21
5-16.	Changing between Remote and Local Operation	5-23
5-17.	Local State.....	5-23
5-18.	Local with Lockout State.....	5-23
5-19.	Remote State.....	5-23
5-20.	Remote with Lockout State	5-23
5-21.	RS-232 Interface Overview	5-24
5-22.	IEEE-488 Interface Overview	5-25
5-23.	Using Commands.....	5-26
5-24.	Types of Commands.....	5-28
5-25.	Device-Dependent Commands.....	5-28
5-26.	Common Commands.....	5-28
5-27.	Query Commands	5-28
5-28.	Interface Messages (IEEE-488)	5-28
5-29.	Compound Commands.....	5-30
5-30.	Coupled Commands.....	5-30
5-31.	Overlapped Commands.....	5-31
5-32.	Sequential Commands.....	5-31
5-33.	Commands that Require the Calibration Switch to be Enabled ...	5-31
5-34.	Commands for RS-232 Only.....	5-31
5-35.	Commands for IEEE-488 Only.....	5-32

5-36.	Command Syntax	5-33
5-37.	Parameter Syntax Rules	5-33
5-38.	Extra Space or Tab Characters	5-34
5-39.	Terminators	5-35
5-40.	Incoming Character Processing	5-35
5-41.	Response Message Syntax	5-36
5-42.	Checking 5820A Status	5-37
5-43.	Serial Poll Status Byte (STB)	5-37
5-44.	Service Request (SRQ) Line	5-39
5-45.	Service Request Enable Register (SRE)	5-39
5-46.	Programming the STB and SRE	5-40
5-47.	Event Status Register (ESR)	5-40
5-48.	Event Status Enable (ESE) Register	5-40
5-49.	Bit Assignments for the ESR and ESE	5-40
5-50.	Programming the ESR and ESE	5-41
5-51.	Instrument Status Register (ISR)	5-42
5-52.	Instrument Status Change Registers	5-42
5-53.	Instrument Status Change Enable Registers	5-42
5-54.	Bit Assignments for the ISR, ISCR, and ISCE	5-42
5-55.	Programming the ISR, ISCR, and ISCE	5-44
5-56.	Output Queue	5-44
5-57.	Error Queue	5-45
5-58.	Remote Program Examples	5-45
5-59.	Guidelines for Programming the Calibrator	5-45
5-60.	Writing an SRQ and Error Handler	5-46
5-61.	Using *OPC?, *OPC, and *WAI	5-47
5-62.	Taking an Impedance Measurement	5-47
5-63.	Using the RS-232 UUT Port to Control an instrument	5-48
5-64.	Input Buffer Operation	5-48

⚠⚠ Warning

To prevent hazardous voltages from being produced without sufficient warning to the operator, the 5820A Calibrator must be programmed with caution. The Calibrator can produce voltages up to 130 V.

Programs should be written carefully and tested extensively to ensure safe operation of the 5820A Calibrator.

Fluke suggests that you include error catching routines in your programs. These error catching routines will assist in detecting programming errors that could result in the instrument behaving differently to your intention. By setting the Service Request Enable (SRQ) register, described in paragraph 5-60, the 5820A Calibrator can be programmed to cause an SRQ when an error is detected. The following program example shows a skeleton program including error catching:

```
10 PRINT @4, "*CLS" ! Clear status
20 PRINT @4, "*SRE 8" ! Set SRE Error Available
30 ON SRQ GOTO 1000 ! Enable SRQ Function
100 ! Place body of program here

900 STOP ! End of program

1000 REM Start of SRQ Handler ! Start routine
1010 PRINT @4, "FAULT?" ! Request fault code
1020 INPUT @4, A% ! Input fault code
1030 PRINT @4, "EXPLAIN? ";A% ! Request fault text
1040 INPUT @4, A$ ! Input fault text
1050 PRINT "Fault ";A$" detected" ! Print message
1060 PRINT @4, "STBY" ! Place 5820A in
standby
1070 STOP
```

5-1. Introduction

This chapter describes methods for operating the 5820A Calibrator by remote control. Remote control can be interactive, with the user controlling each step from a terminal, or under the control of a computer program running the calibrator in an automated system. The 5820A Calibrator rear panel has three ports for remote operations: IEEE-488 parallel port (also known as a General Purpose Interface Bus, or GPIB port), and two RS-232 serial ports, SERIAL 1 FROM HOST and SERIAL 2 TO UUT.

IEEE-488 The IEEE-488 parallel port is usually used in larger control and calibration systems. An IEEE-488 system is more costly to set up, but has the ability to serve multiple 5820A Calibrators and multiple UUTs. Also, parallel system throughput is faster than serial system throughput. The controller in an IEEE-488 system is typically a MS-DOS compatible personal computer (PC) equipped with one or more IEEE-488 ports. You can write your own computer programs for system operation using the command set, or you can purchase optional Fluke calibration software MET/CAL or 5500A/CAL, and property management software MET/TRACK. Typical IEEE-488 configurations are shown in Figure 5-1. The configuration showing the PC with two IEEE-488 ports is used with MET/CAL, which prefers UUTs on a separate IEEE-488 port. You can also “piggy-back” the connectors on a single IEEE-488 port.

RS-232 The SERIAL 1 FROM HOST serial port connects the PC and 5820A Calibrator, while the SERIAL 2 TO UUT serial port acts as a pass-through port, passing commands from the PC to UUT via the 5820A Calibrator. You can write your own computer programs using the command set, or operate the PC as a terminal and enter individual commands, or you can purchase optional Fluke MET/CAL or 5500/CAL software for RS-232 system operations. Typical RS-232 remote configurations are shown in Figure 5-2.

After configuring the IEEE-488 or RS-232 port for remote operation, you are ready to begin using the command set. The operation of the command set is described under “Using Commands” in this chapter. A summary of remote commands are listed in Chapter 6.

5-2. Setting up the IEEE-488 Port for Remote Control

The 5820A Calibrator is fully programmable for use on the IEEE Standard 488.1 interface bus. The IEEE-488 interface is also designed in compliance with supplemental standard IEEE-488.2, which describes additional IEEE-488 features. Devices connected to the IEEE-488 bus are designated as talkers, listeners, talker/listeners, or controllers. Under remote control of an instrument, the 5820A Calibrator operates as a talker/listener.

A PC equipped with an IEEE-488 interface, controls the 5820A Calibrator. Compatible software for IEEE-488 operation may be purchased from Fluke, including METCAL and METRACK. Another software package, 5500/CAL, is also available but operates only on the RS-232 serial interface.

When using the IEEE-488 remote control interface, there are two restrictions:

1. **Number of Devices** A maximum of 15 devices can be connected in a single IEEE-488 bus system. For example, one instrument controller, one 5820A Calibrator, and thirteen units under test (UUTs).
2. **Cable Length** The total length of IEEE-488 cables used in one IEEE-488 system is 2 meters times the number of devices in the system, or 20 meters, whichever is less. For example, if 8 devices are connected, the maximum cable length is $2 \times 8 = 16$ meters. If 15 devices are connected, the maximum cable length is 20 meters.

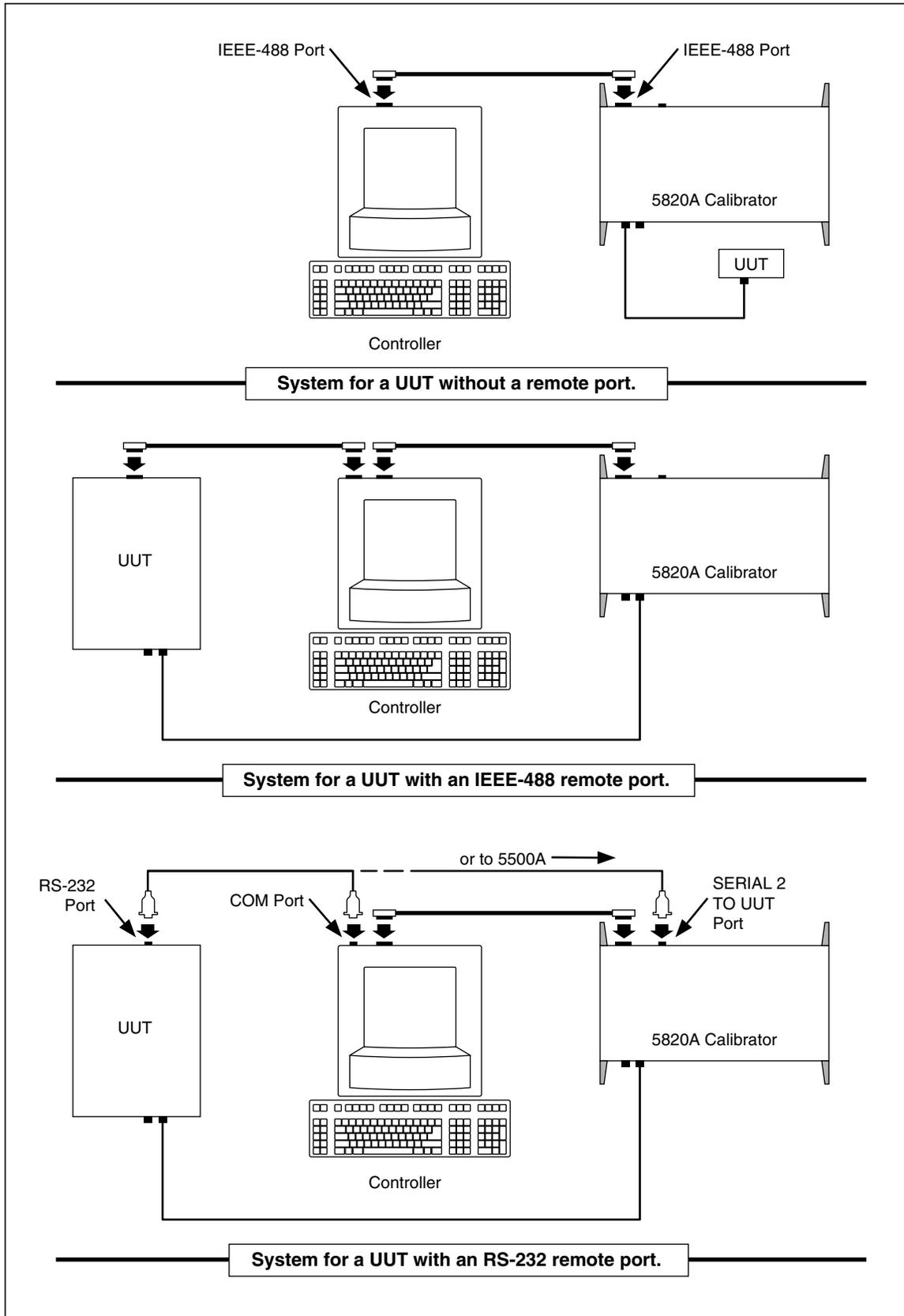

yh030f.eps

Figure 5-1. Typical IEEE-488 Remote Control Connections

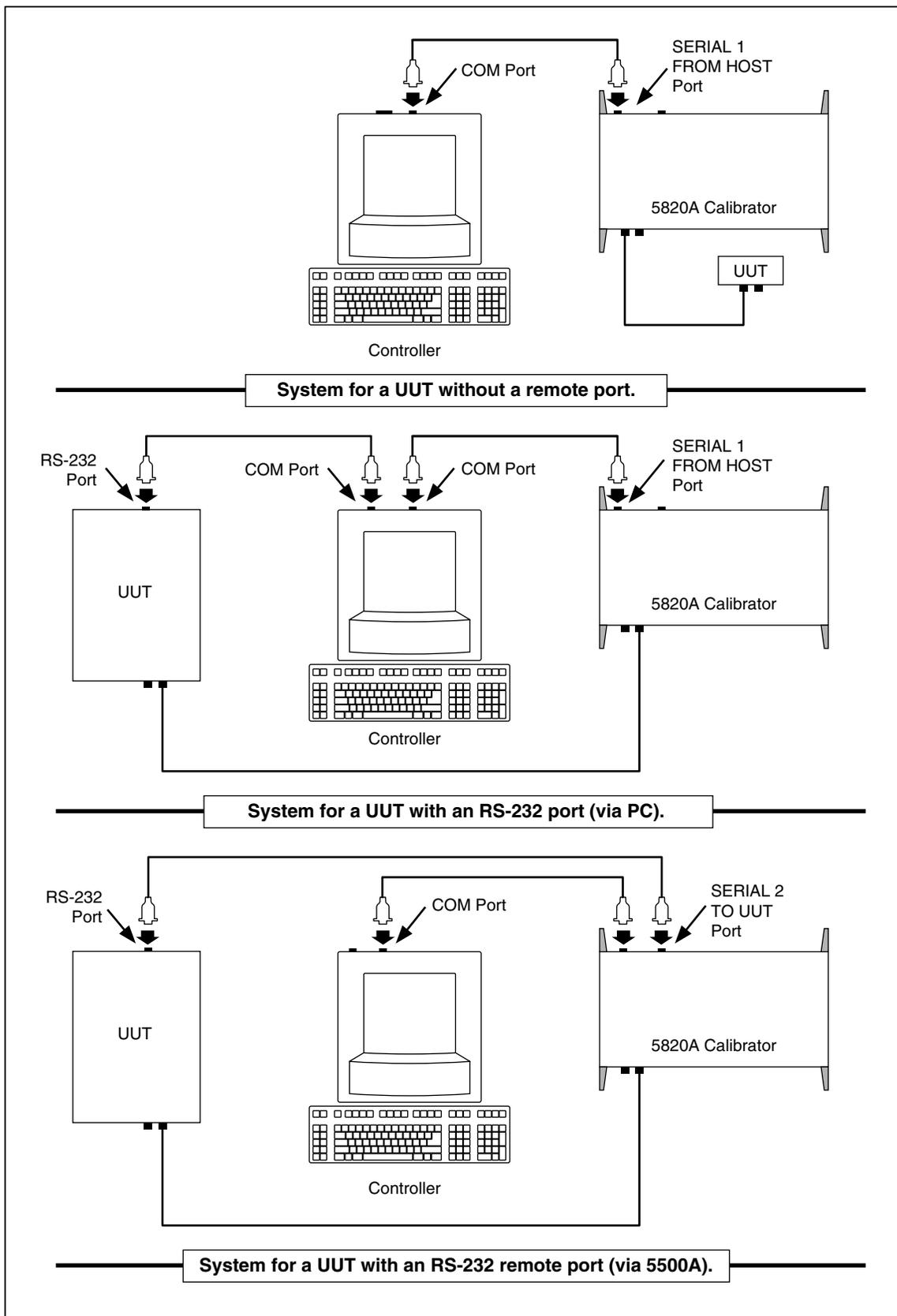

yh031f.eps

Figure 5-2. Typical RS-232 Remote Control Connections

5-3. IEEE-488 Port Setup Procedure

Complete the following procedure to set up the 5820A Calibrator for remote operations using the IEEE-488 remote control port. The purpose is to select GPIB as the interface and to select the GPIB address for the interface.

1. Turn the 5820A Calibrator power on. You may operate the calibrator during warmup, but specifications are not guaranteed until warmup is complete.
2. Press the **SETUP** key on the 5820A Calibrator front panel.
3. Negotiate the softkey selections shown below. Verify the HOST port selection is gpib. Select the desired GPIB port address (0 to 30) using the UP/DOWN softkeys. The factory default is 8.

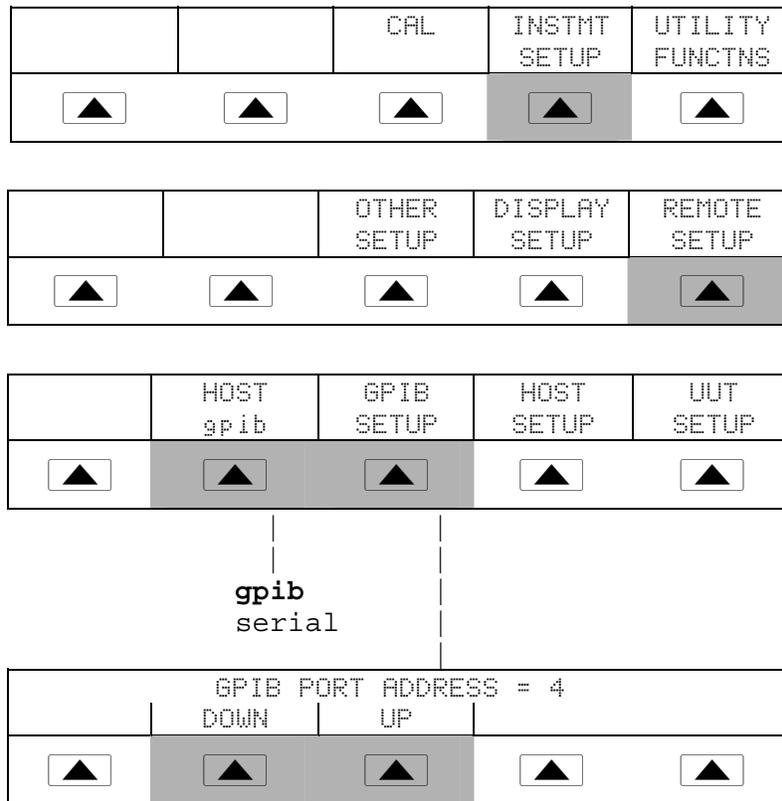

4. Press **PREV MENU** (not **ENTER**) several times until the message STORE CHANGES/DISCARD CHANGES appears or, if there were no changes, the reset display. If you select STORE CHANGES, the gpib and host port setting are saved in the instrument non-volatile memory.

5-4. Testing the IEEE-488 Port

The procedure below tests IEEE-488 communications between the PC and the 5820A Calibrator using the GPIBTEST utility. (See Figure 5-3.) This utility is supplied with the Ziatech ZT-1444A IEEE-488 interface for the PC, which is the recommended interface. (See Chapter 9.) As a reference, Appendix C shows the correct configuration of the ZT-1444A jumpers and DIP switches for various installation configurations. A typical connection is shown below.

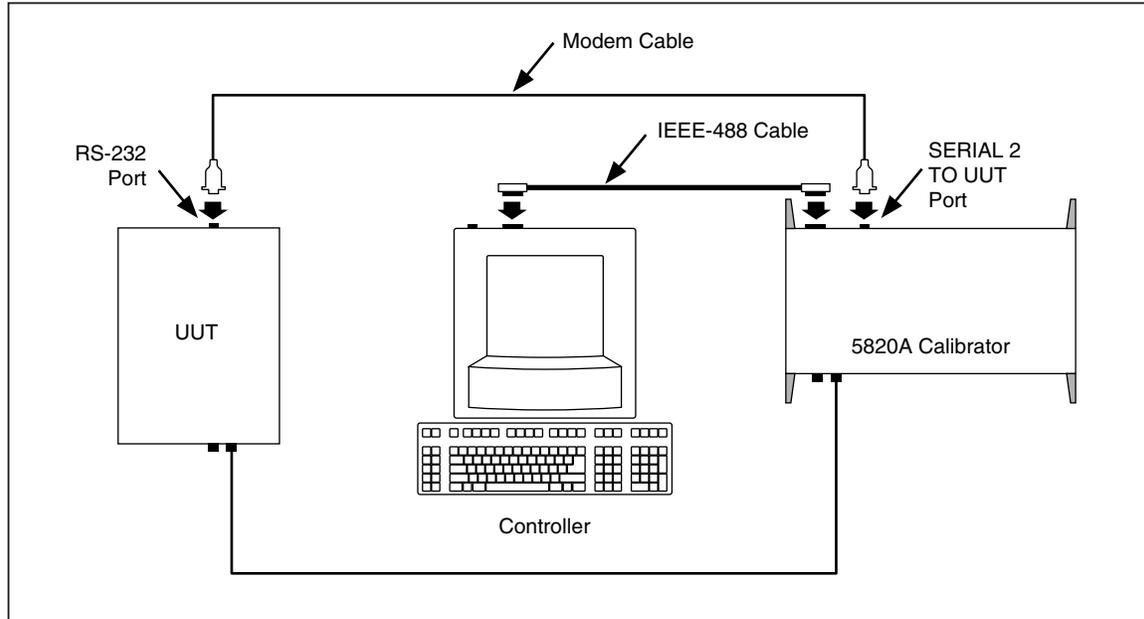

yh039f.eps

Figure 5-3. Testing the IEEE-488 Port

Complete the following procedure to test IEEE-488 operation using GPIBTEST.

1. Complete the "IEEE-488 Port Setup Procedure" earlier in this chapter to set up the 5820A for GPIB operation. Note the GPIB Address Port (default is 4).
2. Connect the PC and 5820A IEEE-488 ports using a standard IEEE-488 cable. (See Chapter 9 for IEEE-488 cables available from Fluke.)
3. Open Windows to the Program Manager screen on your PC.
4. To start the GPIBTEST utility, open GPIB Test from the GPIB group of Program Manager (below).

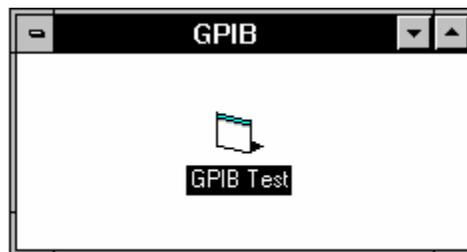

oq018f.bmp

If you have not yet created this group and icon, complete the following:

- a. In Program Manager, select New from the File menu. Check Program Group, then click OK. In the Description box, enter GPIB then click OK. This creates and opens the GPIB group.
- b. With the GPIB group still open, select New from the File menu. Check Program Item, then click OK. In the Description box, enter GPIB Test. In the Command

Line box, enter `c:\win488\gpibtest.exe`, then click OK. This create the GPIB Test icon.

- In the Main Control Window (below), select the GPIB Board command from the Initialize menu, which opens the Parameter Input Window.



oq019f.bmp

- In the Parameter Input Window (below), make the following selections:

Board No.	First
Board Type	ZT 1444A
DMA Channel	0
Initialization	Controller
T1 Delay	Fast
I/O Address	(default) (appears when Board Type is selected)

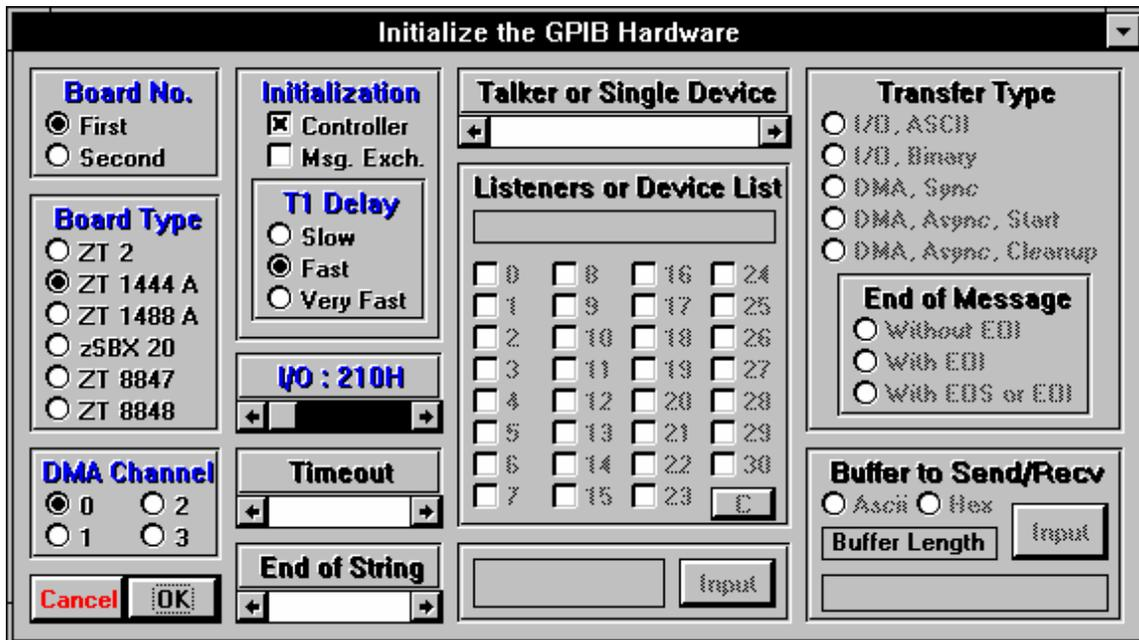

oq020f.bmp

- Click OK. The Parameter Input Window is modeless so it will remain on screen.

8. Verify the 5820A Calibrator is powered and in the reset condition. (If in doubt, press the **RESET** key on the 5820A Calibrator front panel.)
9. In the Main Control Window, select the Remote command from the Control menu. This brings the focus back to the Parameter Input Window with the only selectable item the Listeners or Device List check boxes. Check box 4, or the corresponding GPIB Port Address you selected for the 5820A Calibrator. (Below is typical.)

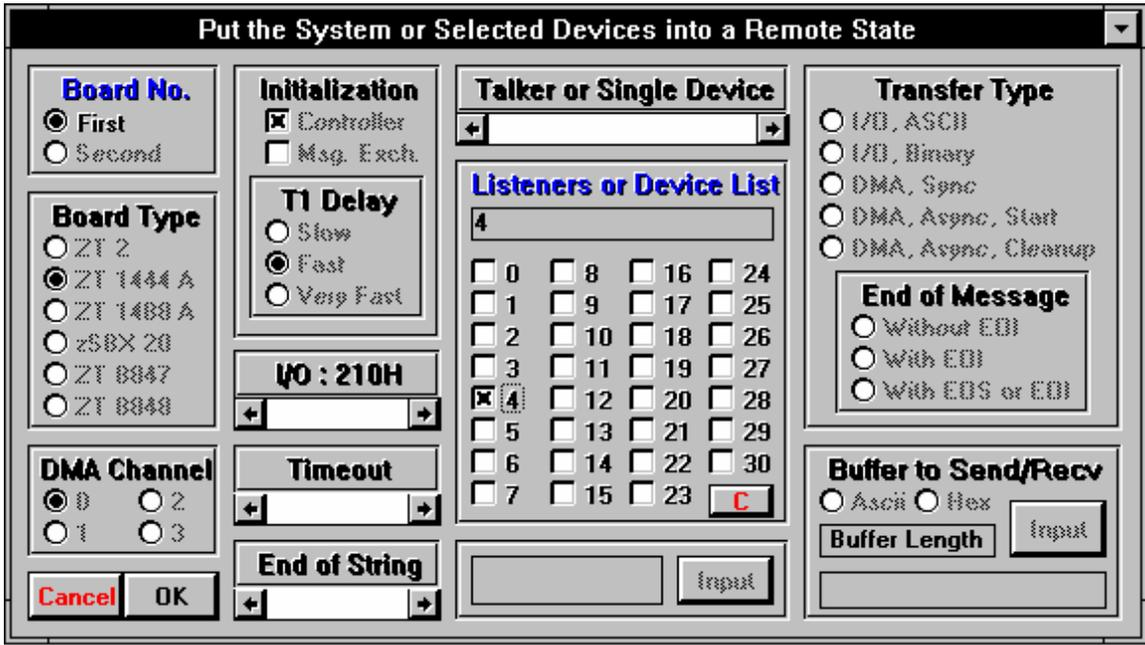

oq021f.bmp

10. Click OK. Observe the 5820A Calibrator Control Display changes to REMOTE CONTROL (below).

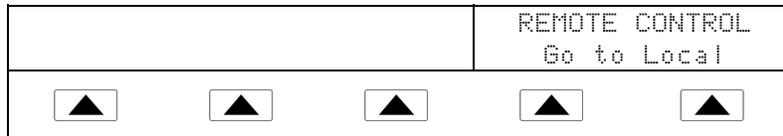

If the Control Display does not change to REMOTE CONTROL, the IEEE-488 interface is not working properly. Check Step 3 of the “IEEE-488 Port Setup Procedure” to verify gpib is selected as the Host port, and to verify the gpib port address used in this procedure. If all is correct, check the ZT-1444A jumper and DIP switch settings (Appendix C), and finally cabling between the PC and 5820A.

11. In a similar manner, select the Local command from the Control menu, then click OK in the Parameter Input Window. Observe the 5820A Calibrator Control Display changes back to the reset condition (below).

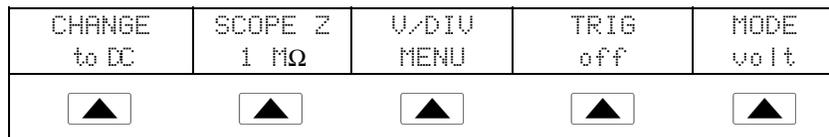

12. In the Main Control Window, select the End GPIB Test command from the Exit menu.

5-5. Setting up the RS-232 Host Port for Remote Control

The 5820A Calibrator is fully programmable over an RS-232 link with a PC the rear panel SERIAL 1 FROM HOST port (Figure 5-2). You can enter individual commands from a terminal, write your own programs using, for example, a Windows-based language such as Visual Basic, or run optional Windows-based Fluke software such as 5500/CAL or MET/CAL.

The RS-232 cable length for the port should not exceed 15 meters (50 feet), although longer cable lengths are permitted if the load capacitance measured at a connection point (including signal terminator) does not exceed 2500 pF.

5-6. RS-232 Host Port Setup Procedure

Complete the following procedure to set up the SERIAL 1 FROM HOST port. The RS-232 parameters you select here must match the parameters set for the PC COM port. The factory defaults (shown below in **bold**) are 9600 baud, 8 data bits, 1 stop bit, and no parity. Other parameters include flow control, EOL (end-of-line) character, and EOF (end-of-file) characters.

1. Turn the 5820A Calibrator power on. You may operate the calibrator during warmup, but specifications are not guaranteed until warmup is complete.
2. Press **SETUP** on the 5820A Calibrator front panel.
3. Negotiate the softkey selections shown below to select the serial port for remote operation, then continue to Step 4.

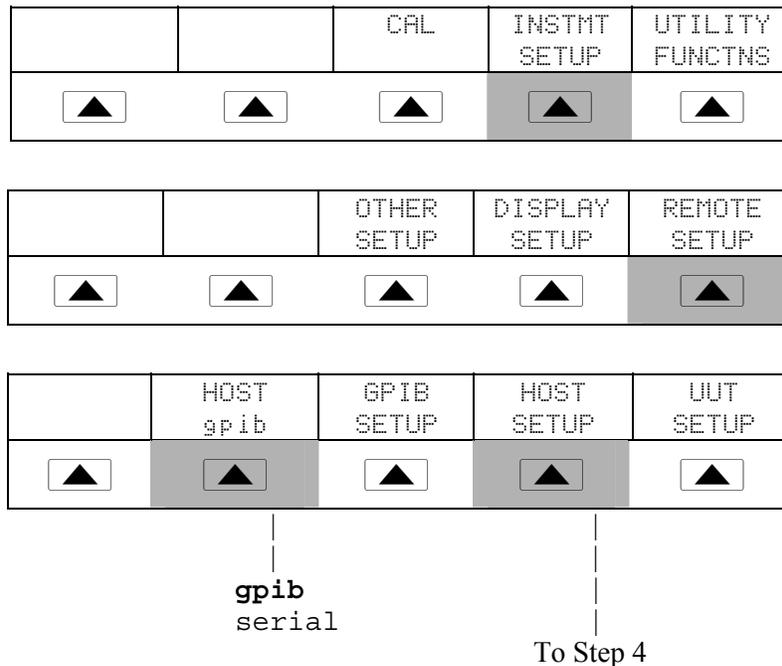

4. Negotiate the softkey selections shown below to select the HOST serial port parameters to match the PC COM parameters. (Individual softkey functions are discussed in Chapter 3.) If operating the port with a computer program instead of individual commands from a terminal, select Remote I/F **comp**.

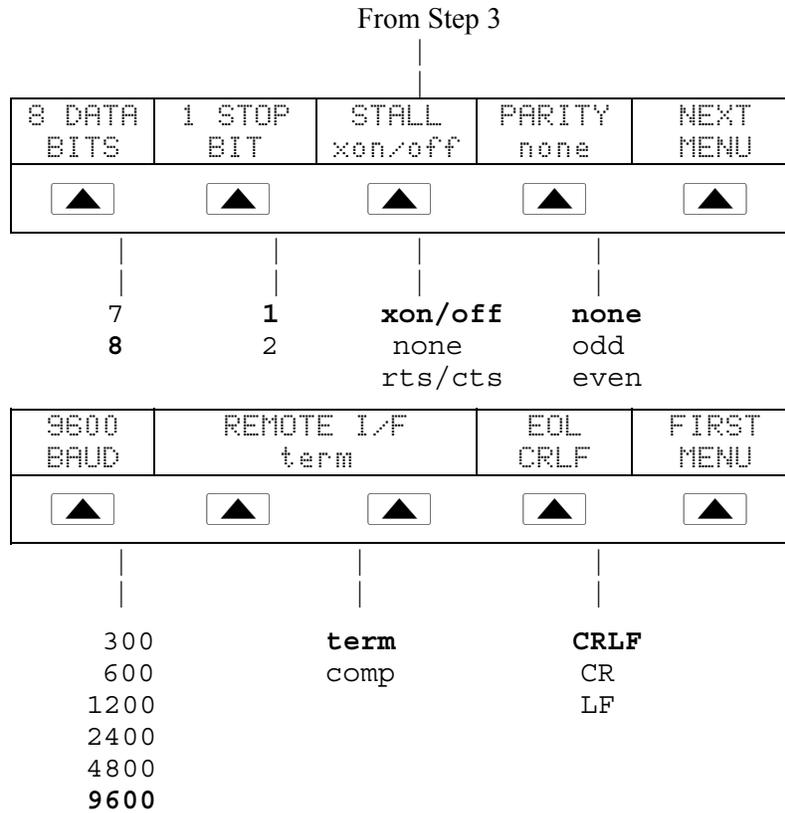

5. Press **PREV MENU** (not **ENTER**) several times until the message STORE CHANGES/DISCARD CHANGES appears or, if there were no changes, the reset displays. If you select STORE CHANGES, the serial and host port setting are saved in the instrument non-volatile memory.

5-7. Testing the RS-232 Host Port

Choose or adapt one of the following test procedures to test the 5820A Calibrator RS-232 Host port connected to a PC COM port. (See Figure 5-4.) A typical connection is shown below. Note the use of a null modem cable for connection. (See Appendix D for information about RS-232 cables and connectors.)

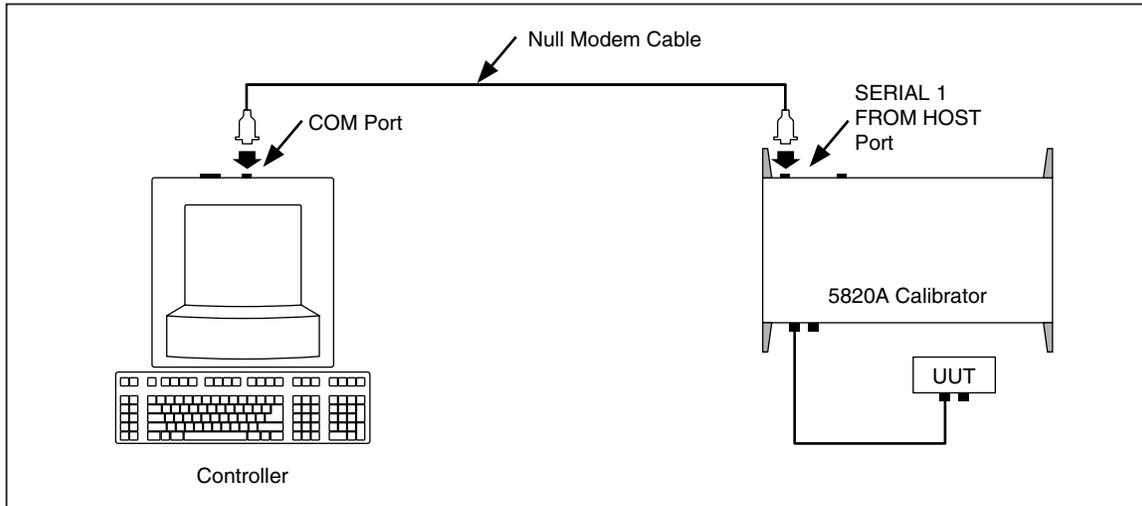

Figure 5-4. Testing the RS-232 Host Port

yh037f.eps

Terminal This procedure uses the Terminal accessory supplied with Windows (or equal) to test RS-232 Host port operation. To use this method, you must select term as the Remote I/F in Step 4 in the procedure “RS-232 Host Port Setup Procedure.”

Visual Basic This procedure uses Visual Basic (see Appendix E) to test RS-232 Host port and RS-232 UUT port operation.

5-8. Testing RS-232 Host Port Operation using a Terminal

Complete the following procedure to test RS-232 Host port operation using the Windows Terminal accessory (or equal).

1. Complete the “RS-232 Host Port Setup Procedure” earlier in this chapter to set up the 5820A for RS-232 Host port operation. Note the RS-232 Host port parameters that you selected in this procedure.
2. Connect the selected COM port on the PC to the 5820A SERIAL 1 FROM HOST port using a standard null-modem RS-232 cable. (See Appendix D for information on RS-232 cables and connectors.)
3. Open Windows to the Program Manager screen on your PC.

- Open Terminal from the Accessory group of Program Manager (below). If a terminal configuration file already exists, e.g., `host.terminal`, select the desired file using the Open command from the File menu and go to Step 7. Otherwise, go to Step 5.

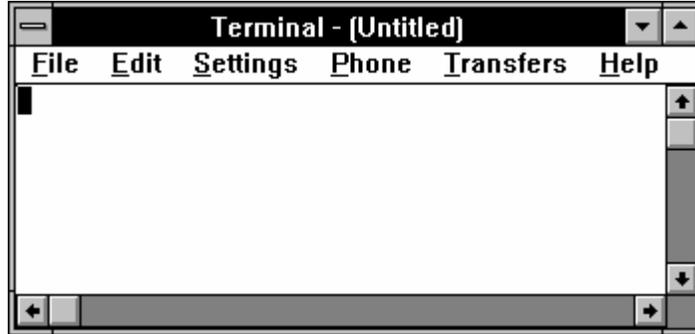

oq022f.bmp

- Select the Communications command from the Setting menu. Enter the RS-232 parameters that match those selected at the 5820A Calibrator for the Host port. If using the 5820A factory defaults, the Communications dialog box for COM1 will appear as shown below. Select COM as required. Click OK.

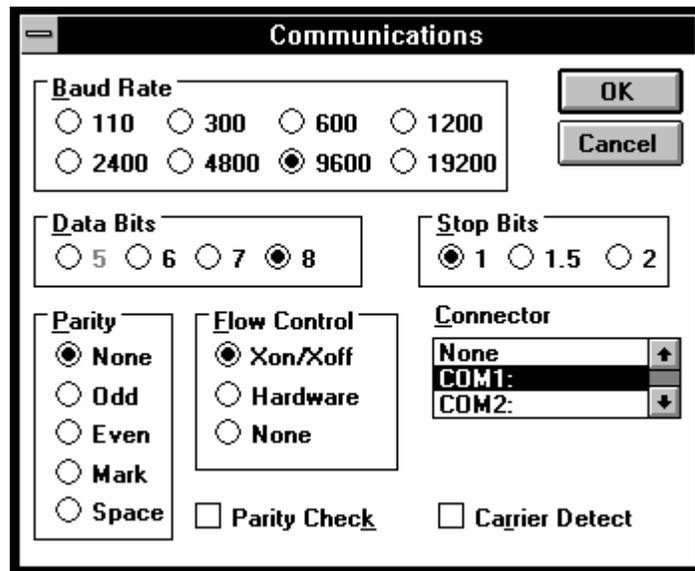

oq023f.bmp

- Verify the 5820A Calibrator is powered and in the reset condition. (If in doubt, press **RESET** on the 5820A Calibrator front panel.)
- On the Terminal screen, type the command `REMOTE` and press **ENTER**. Observe the 5820A Calibrator Control Display changes to `REMOTE CONTROL` (below).

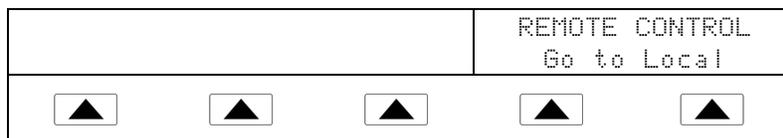

The characters REMOTE should have appeared on the terminal screen as they were entered. If they did not appear on the screen, but the Control Display changed to REMOTE CONTROL, then refer to step 4 of the “RS-232 Host Port Setup Procedure” and change the REMOTE I/F setting from comp to term.

If nonsense characters appeared on the screen, then you have a mismatch in RS-232 parameters. Refer to step 4 of the “RS-232 Host Port Setup Procedure” procedure for the correct RS-232 settings and then repeat this procedure starting at Step 5.

If no characters appeared on the screen, then refer to step 3 of the “RS-232 Host Port Setup Procedure” procedure to verify serial was selected for the Host port. Check that you used the correct RS-232 cable. It must be in a null-modem configuration where the RX and TX lines are reversed (see Appendix D). Also verify you have connected to the correct COM port on the PC.

8. Type the command LOCAL and press . Observe the 5820A Calibrator Control Display changes back to the reset condition (below).

CHANGE to DC	SCOPE Z 1 MΩ	V/DIV MENU	TRIG off	MODE volt
<input type="button" value="▲"/>	<input type="button" value="▲"/>	<input type="button" value="▲"/>	<input type="button" value="▲"/>	<input type="button" value="▲"/>

If you want to experiment with other commands in the command set, see Chapter 6. When finished, select the Exit command from the File menu to close the Terminal accessory.

Hint: To save the communication parameters in Terminal for future operations, first select Save from the File menu and then assign a name, for example, host . trm.

5-9. Testing RS-232 Host Port Operation using Visual Basic

Complete the following procedure to test RS-232 (Host) operation using the Windows-based programming language Visual Basic. This procedure assumes you have completed Appendix E to create the group RS-232 Test.

Complete the following procedure to test RS-232 operation using Visual Basic.

1. Complete the “RS-232 Host Port Setup Procedure” earlier in this chapter to set up the 5820A for RS-232 Host port operation. Note the RS-232 Host port parameters that you selected in this procedure.
2. Connect the selected COM port on the PC to the 5820A SERIAL 1 FROM HOST port using a standard null-modem RS-232 cable. (See Appendix D for information on RS-232 cables and connectors.)
3. To start the program, open the Test Ports icon from the RS-232 Test group (below).

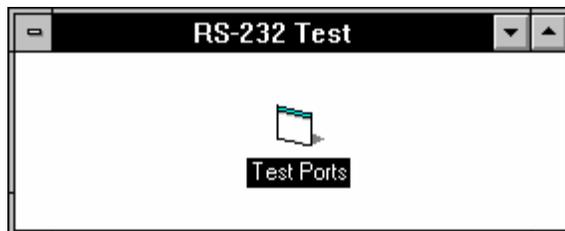

oq024f.bmp

4. Verify the 5820A Calibrator is powered and in the reset condition (if in doubt, press **RESET**), then click the Command1 button (below).

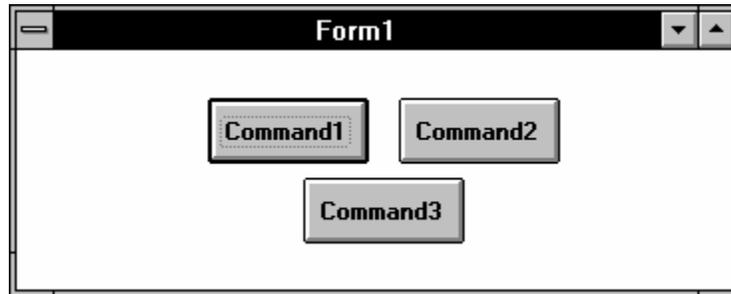

oq025f.bmp

5. Observe the 5820A Calibrator Control Display changes to REMOTE CONTROL (below).

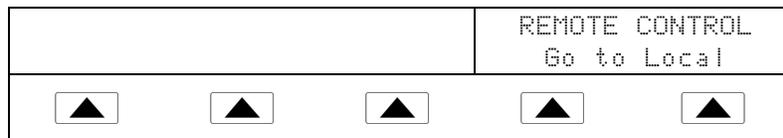

6. Click the Command2 button. Observe the 5820A Calibrator Control Display changes back to the reset condition (below).

(The Command3 button is used for RS-232 UUT port testing later in this chapter.)

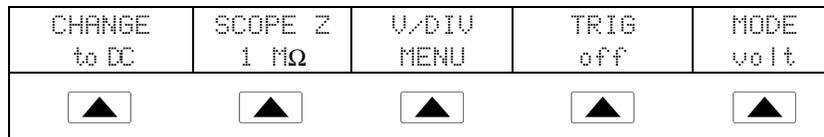

7. Close the program by clicking the top-left corner and Close.

5-10. Setting up the RS-232 UUT Port for Remote Control

The SERIAL 2 TO UUT serial data port connects a UUT to a PC or terminal via the 5820A Calibrator (Figures 5-1 and 5-2). This “pass-through” configuration eliminates the requirement for two COM ports at the PC or Terminal. The UUT_* commands (see Chapter 6) handle the UUT port data flow.

The RS-232 cable length for each port should not exceed 15 meters, although longer cable lengths are permitted if the load capacitance measured at a connection point (including signal terminator) does not exceed 2500 pF.

5-11. RS-232 UUT Port Setup Procedure

Complete the following procedure to set up the SERIAL 2 TO UUT port (defaults in **bold**). The RS-232 parameters you are selecting must match the RS-232 parameters of the UUT. This port operates independently, whether the 5820A Calibrator is controlled from the IEEE-488 port or from the RS-232 Host serial port. (See Figures 5-1 and 5-2.)

1. Turn the 5820A Calibrator power on. You may operate the calibrator during warmup, but specifications are not guaranteed until warmup is complete.
2. Press **SETUP** on the 5820A Calibrator front panel.
3. Negotiate the softkey selections shown below to configure the UUT serial port to match the settings of the UUT RS-232 port. The factory defaults (shown below in **bold**) are 9600 baud, 8 data bits, 1 stop bit, and no parity. Other parameters include flow control (STALL).

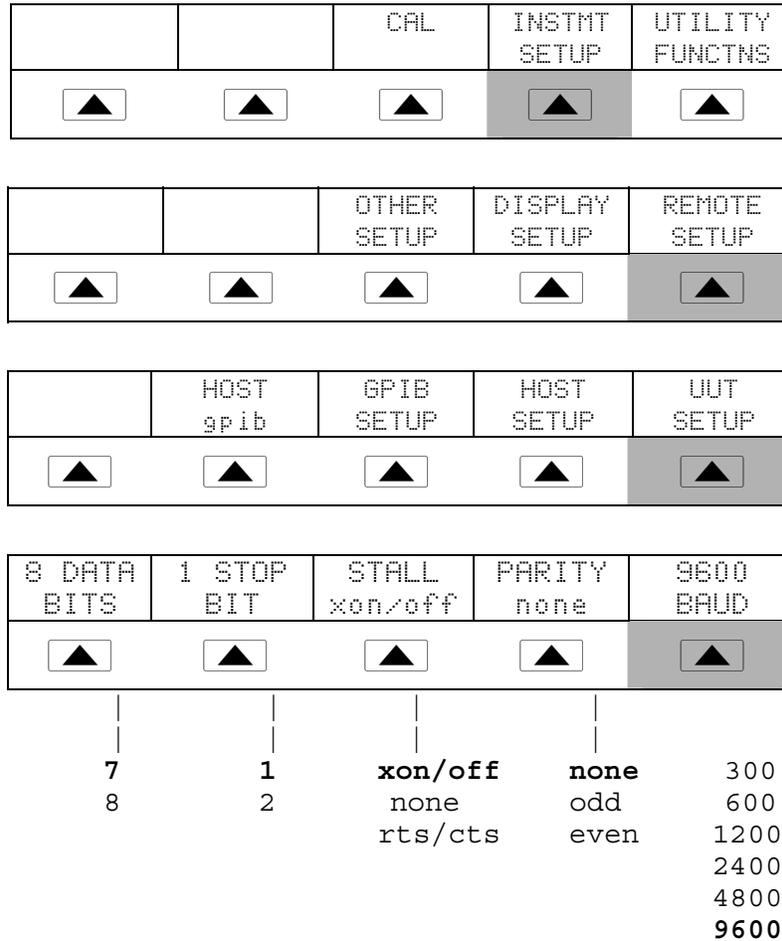

5-12. Testing the RS-232 UUT Port via RS-232 Host Port

Choose or adapt one of the following test procedures to test the 5820A Calibrator RS-232 UUT port via the RS-232 Host port. (See Figure 5-5.) Connect the UUT and PC as shown below. Note the use of a modem cable (NOT null modem) for UUT connection. (See Appendix D for information about RS-232 cables and connectors.)

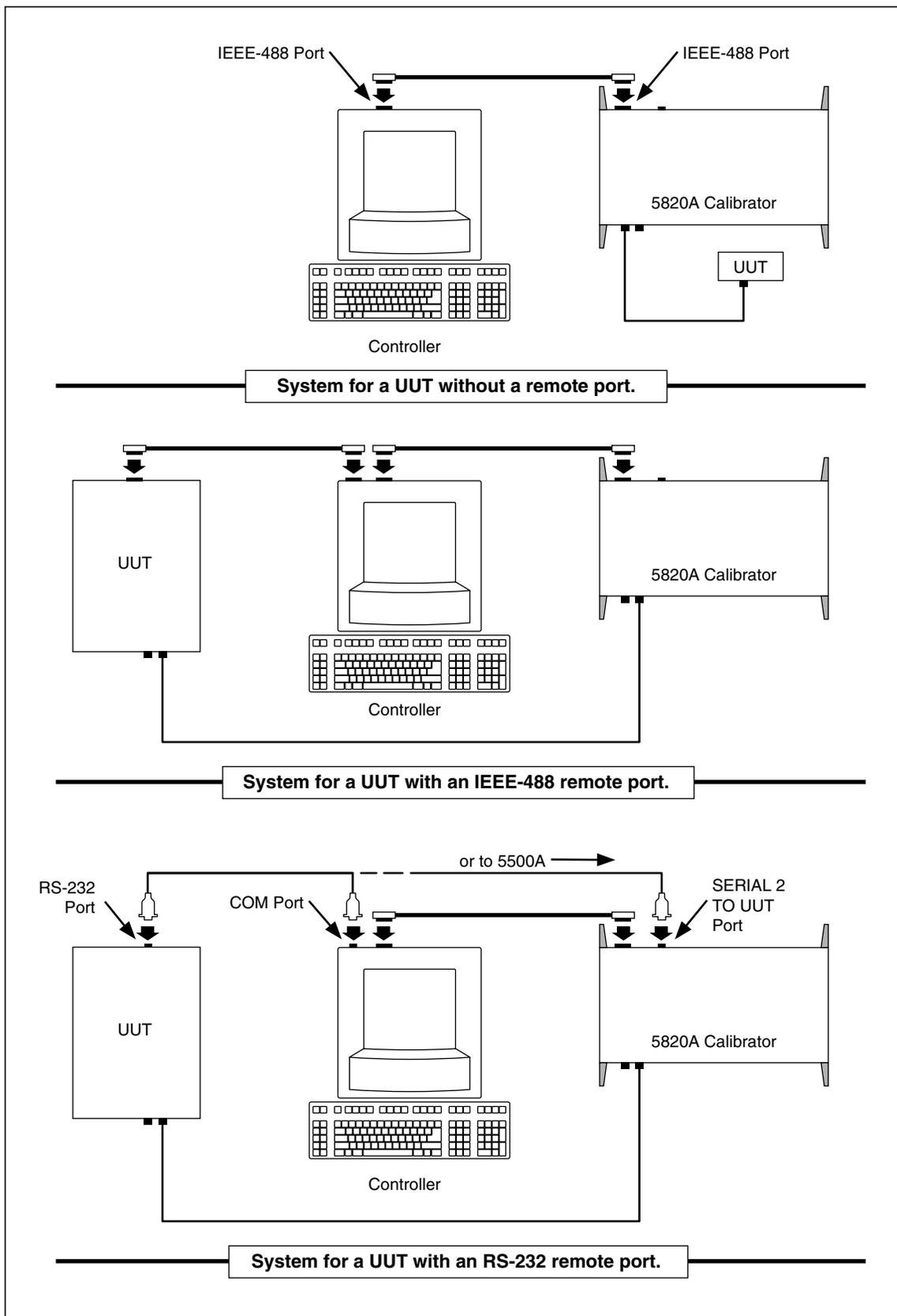

Figure 5-5. Testing the RS-232 UUT Port via the RS-232 Host Port

yh030f.eps

Terminal This procedure uses the Terminal accessory supplied with Windows (or equal) to test RS-232 UUT port operation.

Visual Basic This procedure uses Visual Basic (see Appendix E) to test RS-232 Host port and RS-232 UUT port operation.

5-13. Testing RS-232 UUT Port Operation via a Terminal

Complete the following procedure to test RS-232 UUT port operation via the RS-232 Host port using the Windows Terminal accessory (or equal).

1. Complete “RS-232 UUT Port Setup Procedure” to the 5820A RS-232 UUT port to match the parameters of the UUT RS-232 port.
2. Complete “Testing RS-232 Host Port Operation using a Terminal” to set up the 5820A RS-232 Host port to match the parameters of the PC COM port. After Step 9, return to this procedure and continue to Step 3 below.
3. On the Terminal screen, type `UUT_SEND "<uut command>"` where `<uut command>` is the command you selected for the UUT response, then press `<Enter>`. Observe the UUT responds. For example, to send the command `REMS` to a UUT, use `UUT_SEND "REMS\n"` and press `<Enter>`.

Note the use of `\n`, which indicates a Carriage Return (CR) as the end-of-line character. Other characters include `\r` (Line Feed), `\t` (Tab), `\b` (Backspace) and `\f` (Form Feed). If your UUT commands require an end-of-line character, select one or more of the above.

The characters `UUT_SEND "<uut command>"` should have appeared as they were entered. If they did not appear on the screen, the RS-232 interface between the PC and 5820A Host port is not operating. Review the “RS-232 Host Port Setup Procedure” and correct the problem.

If the UUT command does not execute, refer to step 3 of the “RS-232 UUT Port Setup Procedure” procedure to verify the RS-232 UUT port parameters. Also check the cable for UUT connection was a modem (not null modem) cable. Be sure your command was entered correctly had the proper end-of-line character(s), if required.

4. When finished testing UUT commands, select the Exit command from the File menu to close the Terminal accessory.

5-14. Testing RS-232 UUT Port Operation using Visual Basic

Complete the following procedure to test RS-232 UUT port operation via the RS-232 Host port using a Visual Basic test program. This procedure assumes you have already completed Appendix E to create the program used for this test.

Complete the following procedure to test RS-232 operation using Visual Basic.

1. Complete the “RS-232 UUT Port Setup Procedure” earlier in this chapter to set up the 5820A RS-232 UUT port to match the parameters of the UUT RS-232 port.
2. Complete “Testing RS-232 Host Port Operation using Visual Basic” to prepare the 5820A Calibrator RS-232 Host port. After Step 6, return to this procedure and continue to Step 3 below.
3. Click the Command3 button (below is typical). Observe the UUT responds to the command you used when you completed Appendix E, which discusses how to create a Visual Basic program.

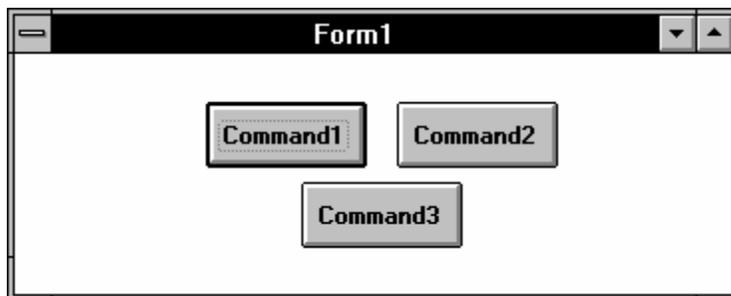

oq025f.bmp

If the UUT did not respond, check the RS-232 parameters set for the 5820A Calibrator UUT port and set for the UUT port. Verify you used a modem (not null modem) cable for the 5820A to UUT connection. Check the Visual Basic program to make sure the UUT command was entered correctly, including the end-of-line character, if any.

4. Close the program by clicking the top-left corner and Close.

5-15. Testing the RS-232 UUT Port via IEEE-488 Port

This procedure uses the GPIBTEST utility supplied with the recommended Ziatech ZT-1444A IEEE-488 PC interface circuit card. Connect the UUT and PC as shown in Figure 5-6. Note the use of a modem cable (NOT null modem) for UUT connection. (See Appendix D for information about RS-232 cables and connectors.)

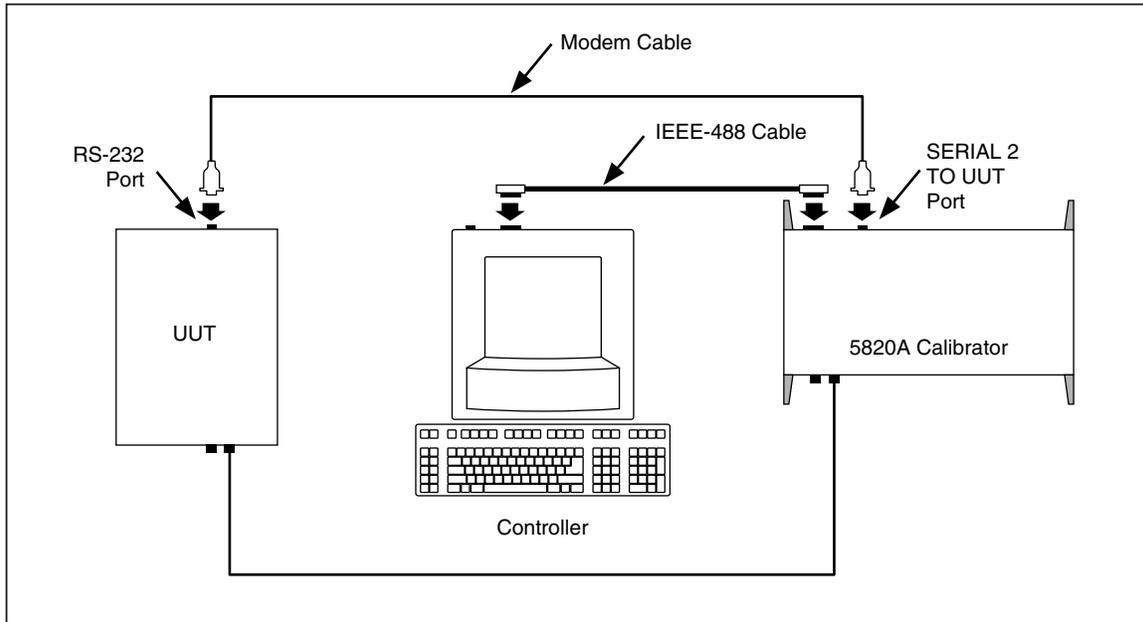

Figure 5-6. Testing the RS-232 UUT Port via IEEE-488 Port

yh039f.eps

Complete the following procedure to test RS-232 UUT port operation via the IEEE-488 port using the GPIBTEST utility.

1. Complete the "IEEE-488 Port Setup Procedure" earlier in this chapter to set up the 5820A for GPIB operation.
2. Complete "Testing the IEEE-488 Port" to prepare the 5820A Calibrator IEEE-488 port for testing. After Step 11, return to this procedure and continue to Step 3 below.
3. In the Main Control Window (below), select the Send to command from the Xfer menu. This brings the focus back to the Parameter Input Window.



oq026f.bmp

4. In the Parameter Input Window (below), make the following selections,
- | | |
|--------------------------|--|
| Listeners or Device List | (5820A Calibrator GPIB address; default 4) |
| Transfer Type | I/O, ASCII |
| End of Message | With EOI |
| Buffer to Send | ASCII |
| UUT_SEND "<uut command>" | |

where <uut command> is the command you selected for the UUT response, then click OK. Observe the UUT responds. For example, to send the command REMS to a UUT, use UUT_SEND "REMS\n".

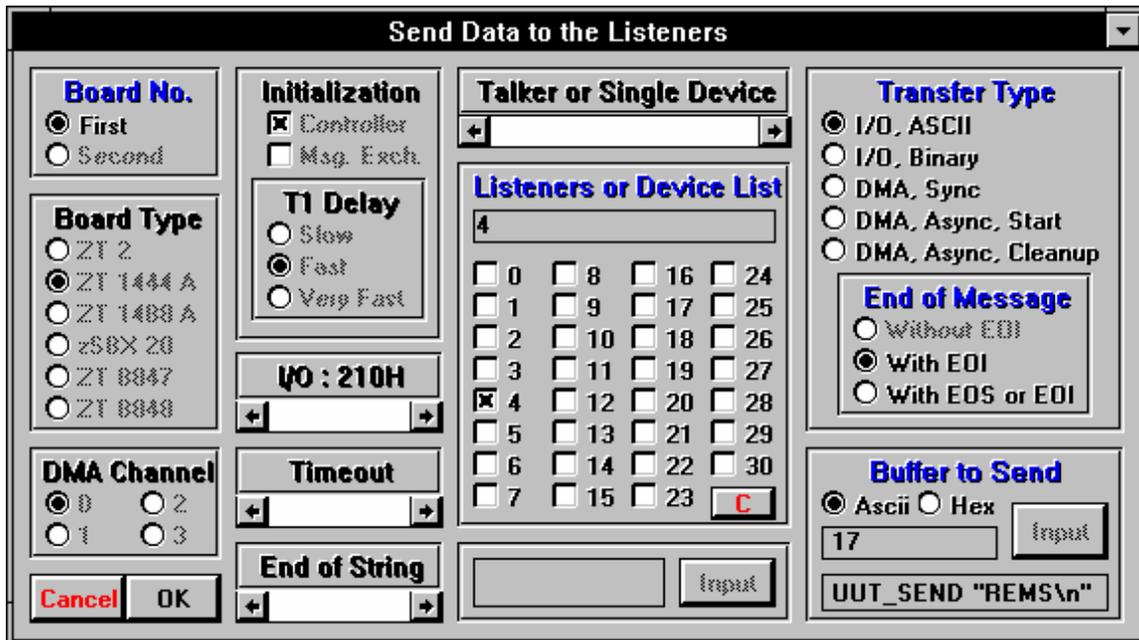

oq065f.bmp

Note the use of \n, which indicates a Carriage Return (CR) as the end-of-line character. Other characters include \r (Line Feed), \t (Tab), \b (Backspace) and \f (Form Feed). If your UUT commands require an end-of-line character, select one or more of the above.

If the UUT command does not execute the command, refer to step 3 of the “RS-232 UUT Port Setup Procedure” procedure to verify the RS-232 UUT port parameters. Also check the cable for UUT connection was a modem (not null modem) cable. Be sure your command was entered correctly and had the correct end-of-line character(s), if required.

5. In the Main Control Window, select the End GPIB Test command from the Exit menu.

5-16. Changing between Remote and Local Operation

In addition to local mode (front panel operation) and remote, the 5820A Calibrator can be placed in a local lockout condition at any time by command of the controller. Combined, the local, remote, and lockout conditions yield four possible operating states described as follows.

5-17. Local State

The 5820A Calibrator responds to local and remote commands. This is normal front panel operation. All remote commands are allowed to execute.

5-18. Local with Lockout State

Local with lockout is identical to local, except the 5820A Calibrator will go into the remote with lockout state instead of the remote state when it receives a remote command.

5-19. Remote State

When the 5820A Calibrator is placed in remote, either via RS-232 REMOTE command, or via IEEE-488 asserting the REN line, it enters the remote state. In the remote state, the Output Display continues to display the output setting or measurement as in local operation. The Control Display changes to:

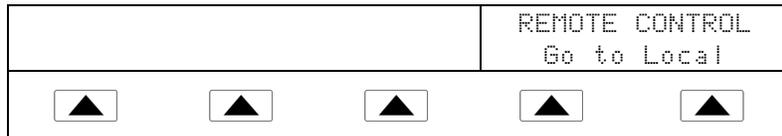

The left side of the Control Display shows information regarding the present output function. However, front panel operation is restricted to use of the power switch and the "Go To Local" softkeys. Pressing either of these softkeys, using RS-232 to send the command LOCAL, or IEEE-488 to send the GTL (Go To Local) message returns the 5820A Calibrator to the local state.

5-20. Remote with Lockout State

When the 5820A Calibrator is placed in lockout, either via RS-232 LOCKOUT command, or via the IEEE-488 message LLO, the 5820A front panel controls are totally locked out. In remote with lockout, the Control Display changes to:



The left side of the Control Display shows information regarding the present output function. However, front panel operation is restricted to use of the power switch. To

return the 5820A Calibrator to the local with lockout state, send the RS-232 LOCAL command or the IEEE-488 GTL (Go To Local) message and unasserts the REN line.

Table 5-1 summarizes the possible Remote/Local state transitions. (For more information on IEEE-488 GPIB messages, see “IEEE-488 Overview.”)

Table 5-1. Operating State Transitions

From	To	Front Panel	GPIB Message	Serial Command
Local	Remote		MLA + (REN True)	REMOTE
	Local with Lockout		LLO	LOCAL
Remote	Local	Go to Local softkey	GTL or REN False	LOCAL
	Remote with Lockout		LLO	LOCKOUT
Local with Lockout	Local		REN False	LOCAL
	Remote with Lockout		MLA (REN True)	REMOTE
Remote with Lockout	Local		REN False	LOCAL
	Local with Lockout		GTL	

5-21. RS-232 Interface Overview

The two 5820A Calibrator RS-232 ports are designed in accordance with EIA (Electronic Industries Association) standard RS-232-C. RS-232 is a serial binary data interchange operating from 300 to 9600 baud (selectable), and distances up to 50 feet. The 5820A Calibrator rear panel SERIAL 1 FROM HOST port is configured as DTE (Data Terminal Equipment) while the SERIAL 2 TO UUT is configured as DCE (Data Communications Equipment). See Appendix D for RS-232 cable and connector information. For detailed information, see the EIA standard RS-232-C.

A summary of RS-232 terms, interface lines and mnemonics are shown in Table 5-2.

Table 5-2. RS-232 Interface Wiring

Mnemonic	Description
CTS	Clear to Send
DB-9	Type DB connector, 9 pins
DB-25	Type DB connector, 25 pins
DCD	Data Carrier Detect
DCE	Data Communications Equipment
DSR	Data Set Ready
DTE	Data Terminal Equipment
DTR	Data Terminal Ready
GND	Ground
RI	Ring Indicator
RLSD	Received Line Signal Detector
RTD	Request to Send
RX	Receive Line
TX	Transmit Line

5-22. IEEE-488 Interface Overview

The IEEE-488 parallel interface sends commands as data and receives measurements and messages as data. The maximum data exchange rate is 1 Mbyte, with a maximum distance of 20 meters for the sum length of the connecting cables. A single cable should not exceed 4 meters in length. Some commands are reserved for RS-232 serial operation because these functions must be implemented as IEEE messages per the IEEE Standards. For example, the command REMOTE could be sent as data over the IEEE-488 interface to place the 5820A Calibrator into remote, but it is not because the IEEE Standards call for the remote function to be sent to the device as the uniline message REN. This is also true for several other commands and functions, as shown below, with their equivalent RS-232 emulation. A summary of IEEE-488 messages is shown in Table 5-3.

Table 5-3. RS-232 Emulation of IEEE-488 Messages

IEEE-488 Message	RS-232 Equivalent
GTL	LOCAL command
GTR	REMOTE command
LLO	LOCKOUT command
SDC, DCL	^C (<Cntl> C) character [clear the device]
GET	^T (<Cntl> T) character [execute a group trigger]
SPE, SPD	^P (<Cntl> P) character [print the serial poll string]
UNL, UNT	(not emulated on RS-232)

The IEEE-488 interface is based on the IEEE Standards 488.1 and 488.2. For detailed information, refer to the standards IEEE-488.1 and IEEE-488.2.

IEEE-488.1 IEEE-488.1 is the hardware portion of the interface. The parallel signal lines are divided into eight lines for the data bus, three lines for the handshake, and five lines for bus management. The handshake lines take care of the timing for data exchange. The bus management lines control the operation of data exchange. The ATN line indicates the use of the DIO lines for addresses or messages (true), or for DIO data (false). The EOI line is used with the data lines to mark the end of a message, and with the ATN line for polling. The SRQ line is used by the devices to indicate to the controller that they require service. The IFC line is used by the controller to quickly get all the devices on the bus to stop talking and start listening. The REN line is used to implement the remote/local states.

IEEE-488.2 IEEE-488.2 is the software portion of the interface, specifying data formats, common commands, message exchange protocol and the status register implementation.

Use the following to decode the columns in table 5-4. Appendix D shows a typical IEEE-488 connector and pin assignments.

Type	M - Multiline U - Uniline	
Class	AC - Addressed Command AD - Address (Talk or listen) UC - Universal Command ST - Status	DD - Device Dependent HS - Handshake SE - Secondary
Other	B1, B2, etc. - Information Bits Blanks - Doesn't Care condition	Logic Zero = 0 = False Logic One = 1 = True

5-23. Using Commands

Communications between the controller and the 5820A Calibrator consists of commands, queries, and interface messages. Although the commands are based on the 488.2 standard, they can be used on either the IEEE-488 or RS-232 interface, except for a few specialized RS-232 commands described in "Commands for RS-232 Only." (For more information on command structures, see the IEEE 488.2 standard.)

Refer to Chapter 6, when you require additional information about command references used in this chapter.

All commands and units may be entered in UPPER or lower case.

IEEE-488 Mode The IEEE-488 mode is used when the 5820A Calibrator is operated by computer program. In this mode, requested information is returned by query, and interface messages are queued and returned by command.

RS-232 Terminal Mode The RS-232 terminal mode is an interactive mode where an operator inputs commands, with immediate returns for requested information (queries) and interface messages.

RS-232 Computer Mode The RS-232 computer mode is used when the 5820A Calibrator is operated by computer program. In this mode, requested information is returned by query, and interface messages are queued and returned by command.

RS-232 Pass-Through Mode The RS-232 pass-through mode is used to pass commands from the PC to a UUT, but via the 5820A Calibrator. This configuration is used when the UUT has an RS-232 port. Commands are sent to the UUT by using the `UUT_SEND` command, returns use the `UUT_RECV?` query, and `UUT_FLUSH` clears the UUT receive buffer in the 5820A Calibrator.

Table 5-4. IEEE-488 Remote Message Coding

MESSAGE DESCRIPTION				DATA BUS								HAND-SHAKE			BUS MANAGEMENT				
M N E M	MESSAGE NAME	T Y P E	C L A S S	D I O 8	D I O 7	D I O 6	D I O 5	D I O 4	D I O 3	D I O 2	D I O 1	D A V	N R F D	N D A C	A T N	E O I	S R Q	I F C	R E N
ACG	Addressed Command Group	M	AC	0	0	0									1				
ATN	Attention	U	UC												1				
DAB	Data Byte	M	DD	B8	B7	B6	B5	B4	B3	B2	B1				0				
DAC	Data Accepted	U	HS											0					
DAV	Data Valid	U	HS									1							
DCL	Device Clear	M	UC	0	0	1	0	1	0	0					1				
END	End	U	ST												0	1			
EOS	End Of String	M	DD	B8	B7	B6	B5	B4	B3	B2	B1				0				
GET	Group Execute Trigger	M	AC	0	0	0	1	0	0	0					1				
GTL	Go To Local	M	AC	0	0	0	0	0	0	1					1				
IDY	Identify	U	UC													1			
IFC	Interface Clear	U	UC															1	
LAG	Listen Address Group	M	AD	0	1										1				
LLO	Local Lock Out	M	UC	0	0	1	0	0	0	1					1				
MLA	My Listen Address	M	AD	0	1	B5	B4	B3	B2	B1					1				
MTA	My Talk Address	M	AD	1	0	B5	B4	B3	B2	B1					1				
MSA	My Secondary Address	M	SE	1	1	B5	B4	B3	B2	B1					1				
NUL	Null Byte	M	DD	0	0	0	0	0	0	0									
OSA	Other Secondary Address	M	SE	(OSA = SCG ^ MSA-NOT)															
OTA	Other Talk Address	M	AD	(OTA = TAG ^ MTA-NOT)															
PCG	Primary Command Group	M	----	(PCG = ACG ~ UCG ~ LAG ~ TAG)															
PPC	Parallel Poll Configure	M	AC	0	0	0	0	1	0	1					1				
PPE	Parallel Poll Enable	M	SE	1	1	0	B4	B3	B2	B1					1				
PPD	Parallel Poll Disable	M	SE	1	1	1	B4	B3	B2	B1					1				
PPR1	Parallel Poll Response 1	U	ST								1				1	1			
PPR2	Parallel Poll Response 2	U	ST							1					1	1			
PPR3	Parallel Poll Response 3	U	ST						1						1	1			
PPR4	Parallel Poll Response 4	U	ST				1								1	1			
PPR5	Parallel Poll Response 5	U	ST			1									1	1			
PPR6	Parallel Poll Response 6	U	ST		1										1	1			
PPR7	Parallel Poll Response 7	U	ST	1											1	1			
PPR8	Parallel Poll Response 8	U	ST	1											1	1			
PPU	Parallel Poll Unconfigure	M	UC	0	0	1	0	1	0	1					1				
REN	Remote Enable	U	UC																1
RFD	Ready For Data	U	HS										0						
RQS	Request For Service	U	ST	1											0				
SCG	Secondary Command Group	M	SE	1	1										1				
SDC	Selected Device Clear	M	AC	0	0	0	0	1	0	0					1				
SPD	Serial Poll Disable	M	UC	0	0	1	1	0	0	1					1				
SPE	Serial Poll Enable	M	UC	0	0	1	1	0	0	0					1				
SRQ	Service Request	U	ST														1		
STB	Status Byte	M	ST	B8		B6	B5	B4	B3	B2	B1				0				
TCT	Take Control	M	AC	0	0	0	1	0	0	1					1				
TAG	Talk Address Group	M	AD	1	0										1				
UCG	Universal Command Group	M	UC	0	0	1									1				
UNL	Unlisten	M	AD	0	1	1	1	1	1	1					1				
UNT	Untalk	M	AD	1	0	1	1	1	1	1					1				

5-24. *Types of Commands*

The commands for the 5820A Calibrator can be grouped into one or more categories, depending on how they function. Each category is described below.

5-25. *Device-Dependent Commands*

Device-dependent commands are unique to the 5820A Calibrator. An example of a device-dependent command is,

```
SCOPE MARKER
```

instructing the 5820A Calibrator to the TIME MARKER function.

5-26. *Common Commands*

Common commands are defined by the IEEE 488.2 standard and are common to most bus devices. Common commands always begin with an * character. Common commands are available whether you are using the IEEE-488 or RS-232 interface for remote control. An example of a common command is,

```
*IDN?
```

instructing the 5820A Calibrator to return the instrument identification string.

5-27. *Query Commands*

Query commands request information, which is returned as the command executes, or placed in a buffer until requested. An example of a query, which always ends with a question mark, is,

```
SCOPE?
```

inquiring about the 5820A mode of operation.

5-28. *Interface Messages (IEEE-488)*

Interface messages manage traffic on the IEEE-488 interface bus. Device addressing and clearing, data handshaking, and commands to place status bytes on the bus are all directed by interface messages. Some of the interface messages occur as state transitions of dedicated control lines. The rest of the interface messages are sent over the data lines with the ATN signal true. (All device-dependent and common commands are sent over the data lines with the ATN signal false.)

An important thing to note about interface messages is that unlike device-dependent and common commands, interface messages are not sent literally (in a direct way). For example, when you send a device-dependent query to the 5820A Calibrator, the controller automatically sends the interface message MTA (My Talk Address).

IEEE-488 standards define interface messages. Table 5-5 lists the interface messages that the 5820A Calibrator accepts. Table 5-5 also shows the BASIC statement to generate the interface message. Table 5-6 lists the interface messages that the calibrator sends. The mnemonics listed in the tables are not sent in BASIC PRINT statements as commands are; in this way they are different from device-dependent and common commands.

Interface messages are handled automatically in most cases. For example, handshake messages DAV, DAC, and RFD automatically occur under the direction of an instrument's interface itself as each byte is sent over the bus.

Table 5-5. IEEE-488 Interface Messages (Receive)

Mnemonic	Name	Function
ATN	Attention	A control line that, when asserted, notifies all instruments on the bus that the next data bytes are an interface message. When ATN is low, the next data bytes are interpreted as device-dependent or common commands addressed to a specific instrument.
DAC	Data Accepted	Sets the handshake signal line NDAC low.
DAV	Data Valid	Asserts the handshake signal line DAV.
DCL	Device Clear	Clears the input/output buffers
END	End	A message that occurs when the Controller asserts the EOI signal line before sending a byte.
GET	Group Execute Trigger	Trigger a TC measurement and put the reading in the output buffer.
GTL	Go To Local	Transfer control of the 5820A from one of the remote states to one of the local states. (See Table 5-1)
LLO	Local Lockout	Transfers remote/local control of the 5820A. (See Table 5-1)
IFC	Interface Clear	A control line that sets the interface to a quiescent state.
MLA	My Listen Address	Addresses a specific device on the bus as a listener. The controller sends MLA automatically whenever it directs a device-dependent or common command to a specific instrument.
MTA	My Talk Address	Addresses a specific device on the bus as a talker. The controller sends MTA automatically whenever it directs a device-dependent or common query to a specific instrument.
REN	Remote Enable	Transfer remote/local control of the 5820A. (See Table 5-1.)
RFD	Ready For Data	Sets the handshake signal line NRFD low.
SDC	Selected Device Clear	Does the same thing as DCL, but only if the 5820A is currently addressed as a listener.
SPD	Serial Poll Disable	Cancels the effect of a Serial Poll Enable.
SPE	Serial Poll Enable	After the 5820A receives this message, it sends the Status Byte the next it is addressed as a listener, no matter what the command is.
UNL	Unlisten	“Unaddresses” a specific device on the bus as a listener. The controller sends UNL automatically after the device has successfully received a device-dependent or common command.
UNT	Untalk	“Unaddresses” a specific device on the bus as a listener. The controller sends UNL automatically after the device has successfully received a device-dependent or common query.

Table 5-6. IEEE-488 Interface Messages (Send)

Mnemonic	Name	Function
END	End	A message that occurs when the 5820A asserts the EOI control line. The 5820A asserts EOI while it transmits the ASCII character LF for its termination sequence or terminator.
DAC	Data Accepted	Set the handshake signal line NDAC low.
DAV	Data Valid	Asserts the handshake signal line DAV.
RFD	Ready for Data	Sets the handshake line NRFD low.
SRQ	Service Request	A control line that any device on the bus can assert to indicate that it requires attention. Refer to “Checking 5820A Status” for details.
STB	Status Byte	The status byte is what the 5820A sends when it responds to a serial poll (interface message SPE).

5-29. Compound Commands

A compound command is two or more commands in a single command line. For example, the following two commands could be entered individually,

```
SCOPE MARKER
OUT 10 ms
OPER
```

where the 5820A Calibrator outputs the TIME MARKER, with a period of 10 ms, and then goes into operate, or they could be combined into a compound command,

```
SCOPE MARKER ; OUT 10 ms ; OPER
```

using a semi-colon as a separator. Care must be taken when a compound command includes any of the coupled commands. (See “Coupled Commands.”)

5-30. Coupled Commands

A coupled command refers to two or more commands that appear in a compound command (see “Compound Commands”) that perform actions that could interfere with each other causing a fault. Commands in a compound command are separated by using the ; character. Compound commands using only coupled commands are not order-dependent.

In Chapter 6, the command graphic shows a check mark for Coupled commands.

The 16 coupled commands are:

CHAN	WAVE	FASTEDG
DC_OFFSET	OUT	REF10MHZ
TRIG_CHAN	OUT_IMP	TRIG
RANGE	SCOPE	TRIGSKEW
TDPULSE	TMWAVE	
VIDEOFMT	VIDEOMRK	

5-31. Overlapped Commands

Commands that begin execution but require slightly more time to complete are called overlapped commands, because they can be overlapped by the next command before they have completed execution.

The 31 overlapped commands are:

CHAN	RANGELCK	REFCLOCK	OLDREF
TRIG_CHAN	*RST	FASTEDG	
TRIG	ZERO_MEAS	REF10MHZ	
RANGE	SCOPE	TRIGSKEW	
TDPULSE	STBY	CAL_ABORT	
TMWAVE	DC_OFFSET	CAL_BACKUP	
INCR	WAVE	CAL_NEXT	
VIDEOFMT	VIDEOMARK	CAL_SKIP	
MULT	OPER	CAL_START	
OUT	OUT_IMP	CAL_SECT	

You can use the command *WAI to wait until the overlapped command has completed execution before executing the next command. For example,

```
SCOPE MARKER OUT 10 ms ; *WAI
```

You can also use the status commands *OPC and *OPC? to detect completion of overlapped commands. (See “Checking 5820A Status.”)

5-32. Sequential Commands

Commands that execute immediately are called sequential commands.

The majority of the commands, 87 of 111 commands, are sequential.

5-33. Commands that Require the Calibration Switch to be Enabled

The following commands do not work unless the rear panel CALIBRATION switch is in the ENABLE position:

```
FORMAT ALL
FORMAT CAL
*PUD
```

Attempting to use any of these commands with the CALIBRATION switch in the NORMAL position logs an error into the error queue. (Or it returns the error message if in the RS-232 Terminal Mode.)

5-34. Commands for RS-232 Only

The IEEE-488 and RS-232 interfaces both send commands to the 5820A Calibrator as data, except for those IEEE-488 functions that must be implemented as a message as specified in the IEEE-488 standards. For example, the RS-232 interface uses the command REMOTE to place the 5820A Calibrator in the remote mode. Although the IEEE-488 interface could also send a command REMOTE as data, it does not because this is one of the functions that must be implemented per IEEE-488 Standards.

The relationship between these IEEE-488 messages and the equivalent RS-232 emulation is shown in Table 5-7.

Table 5-7. Commands for RS-232 Only

IEEE-488 Message [1]	RS-232 Equivalent
GTL	LOCAL command
GTR	REMOTE command
LLO	LOCKOUT command
SRQ	SRQSTR command
SDC, DCL	^C (<Cntl> C) character [clear the device]
GET	^T (<Cntl> T) character [execute a group trigger]
SPE, SPD	^P (<Cntl> P) character [print the serial poll string]
[1] See "How IEEE-488 Operates" later in this chapter.	

In addition to the commands and special characters that emulate the IEEE-488 functions shown above, there are several more commands that are related to operation and control of the actual RS-232 Host port and are therefore completely unrelated to IEEE-488 operations. These include the following six commands.

SP_SET	SPLSTR	SRQSTR
SP_SET?	SPLSTR?	SRQSTR?

5-35. *Commands for IEEE-488 Only*

Commands that are used for the IEEE-488 interface are identified in the command graphic by checking the IEEE-488 check box. This is all the commands, except for those used for RS-232 operations. (See "Commands for RS-232 Only.") All commands are transferred over the IEEE-488 as data, except for the commands LOCAL, REMOTE, and LOCKOUT, which are implemented per IEEE Standards as messages (see Table 5-8).

Table 5-8. Commands for IEEE-488 Only

IEEE-488 Message [1]	Command Representation
GTL	LOCAL command
GTR	REMOTE command
LLO	LOCKOUT command
SDC, DCL	Clear the device
GET	Execute a group trigger
SPE, SPD	Print the serial poll string
[1] See "How IEEE-488 Operates" later in this chapter.	

5-36. Command Syntax

The following syntax rules apply to all the remote commands. Information about syntax of response messages is also given.

5-37. Parameter Syntax Rules

Table 5-9 lists the vocabulary of units accepted in command parameters and used in responses. All commands and units may be entered in UPPER or lower case.

Table 5-9. Units Accepted in Parameters and Used in Responses

Units	Meaning
HZ	Frequency in units of hertz
KHZ	Frequency in units of kilohertz
MHZ, MAHZ	Frequency in units of megahertz
GHZ	Gigahertz
UV	Volts in units of microvolts
MV	Volts in units of millivolts
V	Volts in units of volts
KV	Volts in units of kilovolts
PCT	Percent
PPM	Parts-per-million
DBM	Volts in units of decibels referenced to 1 milliwatt into 50 Ω load
OHM	Resistance in units of ohms
KOHM	Kilohm
MOHM	Megohm
NS	Period in units of nanoseconds
US	Period in units of microseconds
MS	Period in units of milliseconds
S	Period in units of seconds
PS	Picoseconds
F	Capacitance in units of farads
PF	Picofarad
NF	Nanofarad
UF	Microfarad
MF	Millifarad

General Rules The general rules for parameter usage is as follows:

1. When a command has more than one parameter, the parameters must be separated by commas. For example: OUT 1V, 1 KHZ.
2. Numeric parameters may have up to 15 significant digits and their exponents can be in the range +/-1.0E+/-20.
3. Including too many or too few parameters causes a command error.
4. Null parameters cause an error, e.g., the adjacent commas in OUT 1V, , 1 KHZ.
5. Expressions, for example $4+2*13$, are not allowed as parameters.
6. Binary Block Data can be in one of two forms: Indefinite Length and Definite Length format (both IEEE-488.2 standards).

Indefinite Length The Definite Length format accepts data bytes after the #0 until the ASCII Line Feed character is received with an EOI signal (for RS-232 just a line feed or carriage return will terminate the block).

Definite Length The Definite Length format specifies the number of characters that will follow in the <digits> field. These characters must be 0 to 9 (ASCII 48 to 57 decimal). The value of the number in the <digits> field defines the number of user data bytes that will follow in the <user data> field. For examples, see the UUT_SEND and *PUD command descriptions in Chapter 6.

5-38. Extra Space or Tab Characters

In the command descriptions in Chapter 6, parameters are shown separated by spaces. One space after a command is required (unless no parameters are required). All other spaces are optional. Spaces are inserted for clarity in the manual and may be left in or omitted as desired. You can insert extra spaces or tabs between parameters as desired. Extra spaces within a parameter are generally not allowed, except for between a number and its associated multiplier or unit. Chapter 6 contains examples for commands whose parameters or responses are not self-explanatory.

5-39. Terminators

Table 5-10 summarizes the terminator characters for both the IEEE-488 and RS-232 remote interfaces.

Table 5-10. Terminator Characters

Terminator Function	ASCII Character		Control Command Terminator	Language Command Terminator
	Number	Program		
Carriage Return (CR)	13	Chr(13)	<Cntl> M	\n
Line Feed (LF)	10	Chr(10)	<Cntl> J	\r
Backspace (BS)	8	Chr(8)	<Cntl> H	\b
Form Feed (FF)	12	Chr(12)	<Cntl> L	\f
Examples:				
RS-232 Terminal Mode	OUT 1 V, 60 Hz		<Enter>	
	UUT_SEND "REMS\n"		<Enter>	
	UUT_SEND #205REMS^M		<Enter> (^M means <Cntl> M)	
RS-232 Computer Mode (typical to Visual Basic)	Comm1.Output = "OUT 1 V, 60 HZ" + Chr(10)			
	Comm1.Output = "UUT_SEND "REMS\n" " + Chr(10)			
IEEE-488 Mode (command only)	OUT 1 V, 60 Hz			
	UUT_SEND "REMS\n"			

IEEE-488 Interface The 5820A Calibrator sends the ASCII character Line Feed with the EOI control line held high as the terminator for response messages. The calibrator recognizes the following as terminators when encountered in incoming data:

- ASCII LF character
- Any ASCII character sent with the EOI control line asserted

RS-232 Interface The 5820A Calibrator returns an EOL (End of Line) character with each response to the PC. This is selectable as Carriage Return (CR), Line Feed (LF) or both CRLF. (See "RS-232 Host Port Setup Procedure" earlier in this chapter.) Commands sent to the 5820A Calibrator must end in either a CR or LF, or both. (See Table 5-10 above.)

5-40. Incoming Character Processing

The 5820A Calibrator processes all incoming data as follows (except Binary Block Data as described under Parameter Syntax Rules):

1. The most significant data bit (DIO8) is ignored.
2. All data is taken as 7-bit ASCII.
3. Lower-case or upper-case characters are accepted.
4. ASCII characters whose decimal equivalent is less than 32 (Space) are discarded, except for characters 10 (LF) and 13 (CR) and in the *PUD command argument. Binary Block Data allows all characters in its argument and terminates in a special way.

5-41. Response Message Syntax

In the command descriptions in Chapter 6, responses from the 5820A Calibrator are described wherever appropriate. In order to know what type of data to read in, refer to the first part of the entry under "Response" in the tables. The response is identified as one of the data types in Table 5-11.

Table 5-11. Response Data Types

DATA TYPE	DESCRIPTION
Integer	Integers for some controllers or computers are decimal numbers in the range -32768 to 32768. Responses in this range are labeled Integer. Example: *ESE 123; *ESE? returns: 123
Floating	Numbers that may have up to 15 significant figures plus an exponent that may range from $\pm E20$. Example: DC_OFFSET? returns: 1.4293E+00
String	Any ASCII characters including quotation mark delimiters. Example: SRQSTR "SRQ from 5820A"; SRQSTR? returns: "SRQ from 5820A"
Character Response Data (CRD)	This type of response is always a keyword. Example: SCOPE MARKER ; SCOPE? returns: ACV
Indefinite ASCII (IAD)	Any ASCII characters followed by EOM. Queries with this type of response MUST be the last Query in a program message. Example: *OPT? returns: 5820A-5 CAL reports and lists which contains Line Feeds are typically of this type.
Binary Block Data	A special data type defined by the IEEE-488.2 standard. This type is used in *PUD? query. It is defined as follows: #(non-zero digit) (digits) (user data) The non-zero digit specifies the number of characters that will follow in the <digits> field. Characters allowed in the digits field are 0 through 9 (ASCII 48 through 57 decimal). The value of the number in the <digits> field in decimal defines the number of user data bytes that follow in the <user data> field. The maximum response is 64 characters. Example: *PUD "test1"; *PUD? returns: #205test1

5-42. Checking 5820A Status

The programmer has access to status registers, enable registers, and queues in the 5820A Calibrator to indicate various conditions in the instrument as shown in Figure 5-7. Some registers and queues are defined by the IEEE-488.2 standard. The rest are specific to the calibrator. In addition to the status registers, the Service Request (SRQ) control line, and a 16-element buffer called the Error Queue provide status information. Table 5-12 lists the status registers and gives the read/write commands and associated mask registers.

Table 5-12. Status Register Summary

Status Register	Read Command	Write Command
Serial Poll Status Byte (STB)	*STB?	—
Service Request Enable Register (SRE)	*SRE?	*SRE
Event Status Register (ESR)	*ESR?	—
Event Status Enable Register (ESE)	*ESE?	*ESE
Instrument Status Register (ISR)	ISR?	—
Instrument Status Change Register (ISCR)	ISCR?	—
ISCR 1 to 0 transition	ISCR0?	—
ISCR 0 to 1 transition	ISCR1?	—
Instrument Status Change Enable Register (ISCE)	ISCE?	ISCE
ISCE 1 to 0 transition	ISCE0?	ISCE0
ISCE 0 to 1 transition	ISCE1?	ISCE1

Each status register and queue has a summary bit in the Serial Poll Status Byte. Enable registers are used to mask various bits in the status registers and generate summary bits in the Serial Poll Status Byte. For IEEE-488 interface operation, the Service Request Enable Register is used to assert the SRQ control line on detection of any status condition or conditions the programmer chooses. For RS-232 interface operation, the SRQSTR string is sent over the serial interface when the SRQ line is set. (See the SRQSTR command description in Chapter 6 for more information.)

5-43. Serial Poll Status Byte (STB)

The 5820A Calibrator sends the serial poll status byte (STB) when it responds to a serial poll. This byte is cleared (set to 0) when the power is turned on. The value of this byte at power-on is determined by the value of the service request enable register (SRE), which is saved in nonvolatile memory. The STB byte is defined as shown in Figures 5-8. If you are using the RS-232 as the remote control interface, transmitting the ^P character (in the Terminal mode, hold down the <Cntl> key and press P) returns the SPLSTR (Serial Poll String) and the status byte. Refer to the *STB command, and for RS-232 interface operation, the SPLSTR and SPLSTR? commands, in Chapter 6 for more information.

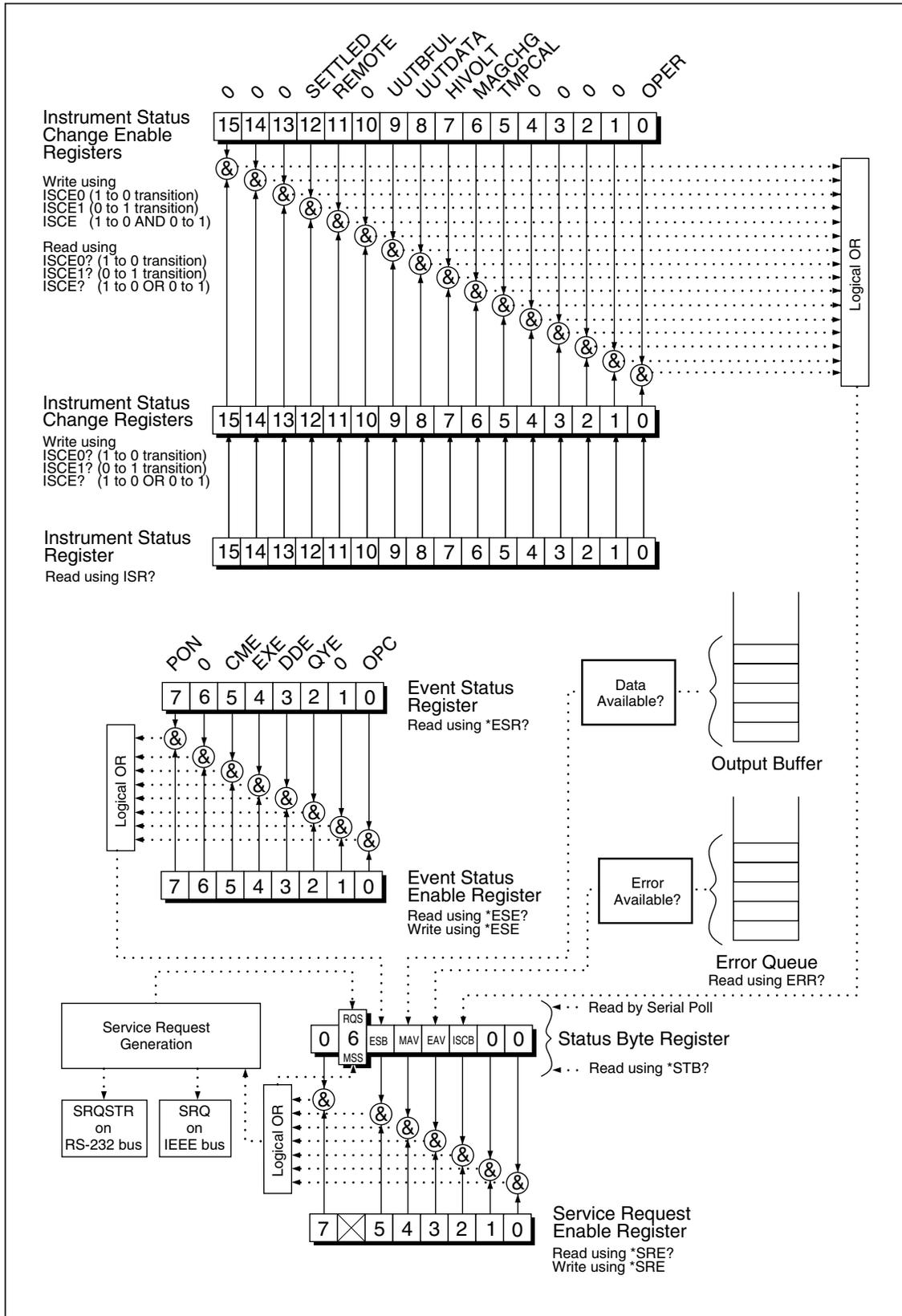

oq032f.eps

Figure 5-7. Status Register Overview

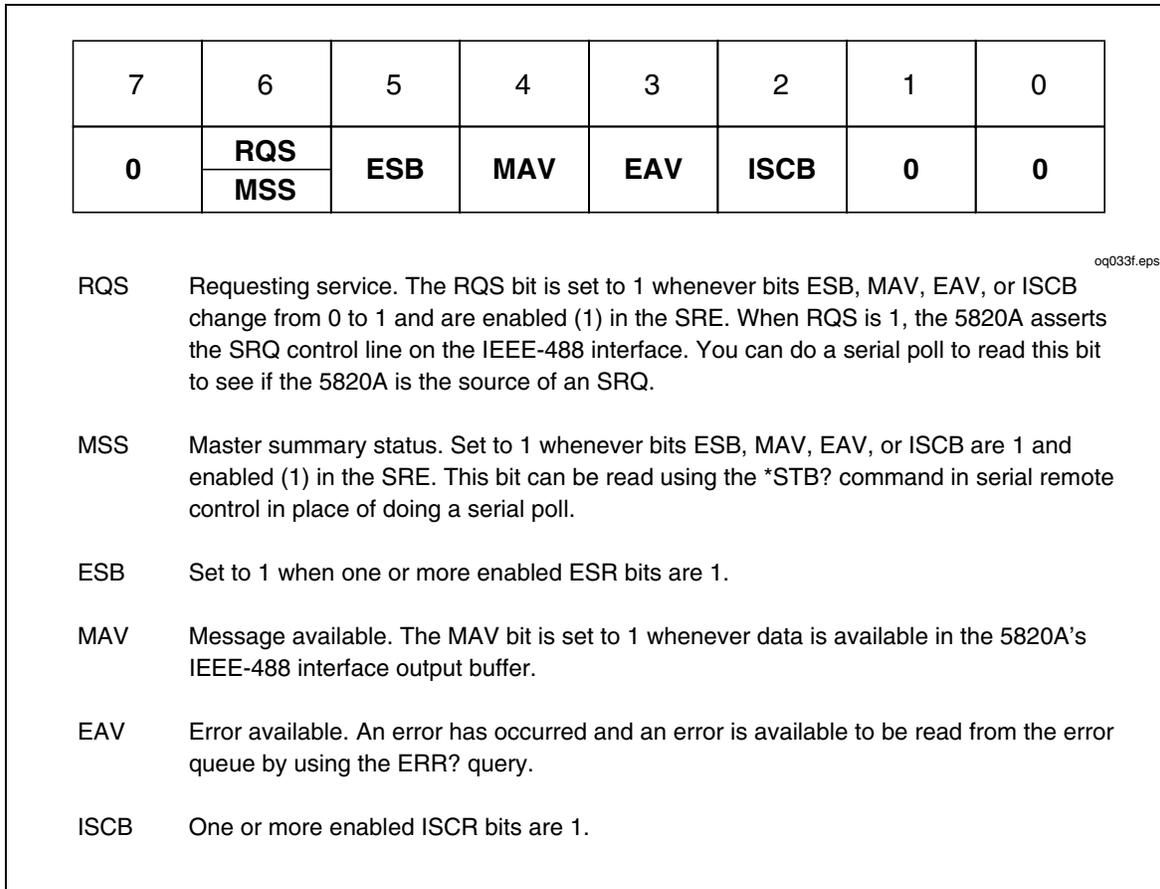

Figure 5-8. Serial Poll Status Byte (STB) and Service Request Enable (SRE)

5-44. Service Request (SRQ) Line

IEEE-488 Service Request (SRQ) is an IEEE-488.1 bus control line that the 5820A Calibrator asserts to notify the controller that it requires some type of service. Many instruments can be on the bus, but they all share a single SRQ line. To determine which instrument set SRQ, the Controller normally does a serial poll of each instrument. The calibrator asserts SRQ whenever the RQS bit in its Serial Poll Status Byte is 1. This bit informs the controller that the calibrator was the source of the SRQ.

RS-232 Remote operations using the RS-232 interface emulate the IEEE-488 SRQ line by sending the SRQSTR string over the serial interface when the SRQ line is set. (See the SRQSTR command description in Chapter 6 for more information.)

The 5820A Calibrator clears SRQ and RQS whenever the controller/host performs a serial poll, sends *CLS, or whenever the MSS bit is cleared. The MSS bit is cleared only when ESB, MAV, EAV, and ISCB are 0, or they are disabled by their associated enable bits in the SRE register being set to 0.

5-45. Service Request Enable Register (SRE)

The Service Request Enable Register (SRE) enables or masks the bits of the Serial Poll Status Byte. The SRE is cleared at power up. Refer to Figure 5-9 for the bit functions.

5-46. Programming the STB and SRE

By resetting (to 0) the bits in the SRE, you can mask (disable) associated bits in the serial poll status byte. Bits set to 1 enable the associated bit in the serial poll status byte. The following sample BASIC program enables the Error Available (EAV) bit.

```

10 ! THIS PROGRAM SETS EAV IN THE SRE
20 PRINT @6, "*"SRE 8"           ! LOAD THE REGISTER
30 PRINT @6, "*"SRE?"           ! ASK FOR THE SRE CONTENTS
40 INPUT @6, A%                 ! RETRIEVE THE REGISTER CONTENTS
50 PRINT "SRE = ";A%
60 RETURN

```

The following BASIC program generates an error and checks the Serial Poll Status Byte. Enable the EAV bit with the example above.

```

10 ! THIS PROGRAM GENERATES AN ERROR AND CHECKS IT
20 PRINT @6, "OUT 1300V"         ! 1300V IS OUT OF 5820A RANGE
30 A% = SPL(6)                  ! DO A SERIAL POLL
40 IF ((A% AND 72%)=0%) THEN PRINT "EAV and RQS should have been set"
50 PRINT @6, "*"STB?"           ! RETRIEVE BYTE
60 INPUT @6, A%
70 IF ((A% AND 8%)=0%) THEN PRINT "EAV should have been set"

```

5-47. Event Status Register (ESR)

The Event Status Register is a two-byte register in which the higher eight bits are always 0, and the lower eight bits represent various conditions of the 5820A Calibrator. The ESR is cleared (set to 0) when the power is turned on, and every time it is read.

Many of the remote commands require parameters. Improper use of parameters causes command errors to occur. When a command error occurs, bit CME (5) in the Event Status Register (ESR) goes to 1 (if enabled in ESE register), and the error is logged in the error queue.

5-48. Event Status Enable (ESE) Register

A mask register called the Event Status Enable register (ESE) allows the controller to enable or mask (disable) each bit in the ESR. When a bit in the ESE is 1, the corresponding bit in the ESR is enabled. When any enabled bit in the ESR is 1, the ESB bit in the Serial Poll Status Byte also goes to 1. The ESR bit stays 1 until the controller reads the ESR or does a device clear, a selected device clear, or sends the reset or *CLS command to the calibrator. The ESE is cleared (set to 0) when the power is turned on.

5-49. Bit Assignments for the ESR and ESE

The bits in the Event Status Register (ESR) and Event Status Enable register (ESE) are assigned as shown in Figure 5-10.

15	14	13	12	11	10	9	8
0	0	0	0	0	0	0	0
7	6	5	4	3	2	1	0
PON	0	CME	EXE	DDE	QYE	0	OPC

oq034f.eps

- PON** Power on. This bit is set to 1 if line power has been turned off and on since the last time the ESR was read.
- CME** Command error. The 5820A's IEEE-488 interface encountered an incorrectly formed command. (The command ERR? fetches the earliest error code in the error queue, which contains error codes for the first 15 errors that have occurred.)
- EXE** Execution error. An error occurred while the 5820A tried to execute the last command. This could be caused, for example, by a parameter being out of range. (The command ERR? fetches the earliest error in the error queue, which contains error codes for the first 15 errors that have occurred.)
- DDE** Device-dependent error. An error related to a device-dependent command has occurred.
- QYE** Query error. The 5820A was addressed to talk when no response data was available or appropriate, or when the controller failed to retrieve data on the output queue.
- OPC** Operation complete. All commands previous to reception of a *OPC command have been executed, and the interface is ready to accept another message.

Figure 5-9. Event Status Register (ESR) and Event Status Enable (ESE)

5-50. Programming the ESR and ESE

To read the contents of the ESR, send the remote command, *ESR?. The ESR is cleared (set to 0) every time it is read. To read the contents of the ESE, send the remote command, *ESE?. The ESE is not cleared when it is read. When you read either register, the 5820A Calibrator responds by sending a decimal number that when converted to binary represents bits 0 through 15. The following sample BASIC program retrieves the contents of both registers:

```

10 ! THIS PROGRAM READS THE ESR AND THE ESE REGISTERS
20 PRINT @6, "*ESR?"           ! ASK FOR THE ESR CONTENTS
30 INPUT @6, A%                ! RETRIEVE THE REGISTER CONTENTS
40 PRINT @6, "*ESE?"           ! ASK FOR THE ESE CONTENTS
50 INPUT @6, B%                ! RETRIEVE THE REGISTER CONTENTS
60 PRINT "ESR = ";A%           ! DISPLAY THE ESR REGISTER CONTENTS VALUE
70 PRINT "ESE = ";B%           ! DISPLAY THE ESE REGISTER CONTENTS VALUE
80 END

```

Convert the contents of variables A and B into binary, and you can read the status of the registers. For example if A is 32, its binary equivalent is: 00000000 00100000. Therefore, bit 5 (CME) in the ESR is set (1) and the rest of the bits are reset (0). This means that the calibrator tried to execute an incorrectly formed command.

By setting the bits in the ESE, you can mask (disable) the associated bits in the ESR. For example, to prevent the occurrence of a command error from causing bit 5 (ESB) in the serial poll status byte to go to 1, you can reset (to 0) bit 5 in the ESE register. The following sample program accomplishes this by checking the status of the CME bit, then toggling it if it is 1.

```

10 ! THIS PROGRAM RESETS BIT 5 (CME) IN THE ESE
20 PRINT @6, "*ESE 33" ! INITIAL ESE IS CME + OPC
30 GOSUB 100 ! GET AND PRINT INITIAL ESE
40 IF (A% AND 32%) THEN A% = A% - 32% ! CLEAR CME (BIT 5)
50 PRINT @6, "*ESE ";A% ! LOAD ESE WITH NEW VALUE
60 GOSUB 100 ! GET AND PRINT NEW ESE
70 END
100 PRINT @6, "*ESE?" ! ASK FOR ESE CONTENTS
110 INPUT @6, A% ! RETRIEVE REGISTER CONTENTS
120 PRINT "ESE = ";A%
130 RETURN

```

5-51. Instrument Status Register (ISR)

The Instrument Status Register (ISR) gives the controller access to the state of the 5820A Calibrator, including some of the information presented to the operator on the Control Display and the display annunciators during local operation.

5-52. Instrument Status Change Registers

There are two registers dedicated to monitoring changes in the ISR. These are the ISCR0 (Instrument Status 1-0 Change Register) and the ISCR1 (Instrument Status 0-1 Change Register). Each status change register has an associated mask register. Each ISCR is cleared (set to 0) when the 5820A Calibrator is turned on, every time it is read, and at each *CLS (Clear Status) command.

5-53. Instrument Status Change Enable Registers

The Instrument Status Change Enable registers (ISCE0 and ISCE1) are mask registers for the ISCR0 and ISCR1 registers. If a bit in the ISCE is enabled (set to 1) and the corresponding bit in the ISCR makes the appropriate transition, the ISCB bit in the Status Byte is set to 1. If all bits in the ISCE are disabled (set to 0), the ISCB bit in the Status Byte never goes to 1. The contents of the ISCE registers are set to 0 at power-up.

5-54. Bit Assignments for the ISR, ISCR, and ISCE

The bits in the Instrument Status, Instrument Status Change, and Instrument Status Change Enable registers are assigned as shown in Figure 5-10.

15	14	13	12	11	10	9	8
0	0	0	SETTLED	REMOTE	0	UUTBFUL	UUTDATA

7	6	5	4	3	2	1	0
HIVOLT	MAGCHG	TMPCAL	0	0	0	0	OPER

oq035f.eps

SETTLED	Set to 1 when the output has stabilized to within specification or the TC measurement has settled and is available.
REMOTE	Set to 1 when the 5820A is under remote control.
UUTBFUL	Set to 1 when data from the UUT port has filled up the UUT buffer.
UUTDATA	Set to 1 when there is data available from the UUT port.
HIVOLT	Set to 1 when the 5820A is programmed to a voltage above 33 Volts.
MAGCHG	Set to 1 when the output magnitude has changed as a result of another change. This bit is always 0 in the ISR. It changes to 1 only in the ISCR0 and ISCR1 registers.
TMPCAL	Set to 1 when the 5820A is using temporary (non-stored) calibration data.
OPER	Set to 1 when the 5820A is in operate, 0 when it is in standby.

Figure 5-10. Bit Assignments for the ISR, ISCEs and ISCRs

5-55. Programming the ISR, ISCR, and ISCE

To read the contents of the ISR, send the remote command, `ISR?`. To read the contents of the ISCR0 or 1, send the remote command, `ISCR0?`, or `ISCR1?`. To read the contents of the ISCE0 or 1, send the remote command, `ISCE0?`, or `ISCE1?`. The 5820A Calibrator responds by sending a decimal number that represents bits 0 through 15. Every time you read the ISCR0 or 1, its contents are zeroed. The following sample program reads all five registers:

```

10 ! THIS PROGRAM READS THE ISR, ISCR, AND ISCE REGISTERS
20 ! NOTE THAT THE ICSR? COMMANDS CLEAR THE ISCR CONTENTS
30 PRINT @6, "ISR?" ! ASK ISR CONTENTS
40 INPUT @6, A% ! RETRIEVE REGISTER CONTENTS FROM 5820A
50 PRINT @6, "ISCR0?" ! ASK FOR AND CLEAR ISCR0 CONTENTS
60 INPUT @6, B% ! RETRIEVE REGISTER CONTENTS FROM 5820A
70 PRINT @6, "ISCE0?" ! ASK FOR ISCE0 CONTENTS
80 INPUT @6, C% ! RETRIEVE REGISTER CONTENTS FROM 5820A
90 PRINT @6, "ISCR1?" ! ASK FOR AND CLEAR ISCR1 CONTENTS
100 INPUT @6, D% ! RETRIEVE REGISTER CONTENTS FROM 5820A
110 PRINT @6, "ISCE1?" ! ASK FOR ISCE1 CONTENTS
120 INPUT @6, E% ! RETRIEVE REGISTER CONTENTS FROM 5820A
130 PRINT "ISR = ";A% ! DISPLAY ISR
140 PRINT "ISCR0 = ";B% ! DISPLAY ISCR0
150 PRINT "ISCE0 = ";C% ! DISPLAY ISCE0
160 PRINT "ISCR1 = ";D% ! DISPLAY ISCR1
170 PRINT "ISCE1 = ";E% ! DISPLAY ISCE1
180 END

```

Convert the returned variables into binary, and you can read the status of the instrument. For example if a register contains 4, its binary equivalent is: 00000000 00000100. Therefore, bit 3 (VBOOST) is set (1) and the rest of the bits are reset (0).

By setting the bits in an ISCE register, you can mask (disable) the associated bits in the ISCR. For example, to cause an SRQ interrupt when the output has settled, bit 12 (SETTLED) in the ISCE1 register must be 1. (The ISCB bit must also be enabled in the SRE.) The following sample program loads a decimal 1024 into the ISCE, which sets bit 12 and resets the other bits:

```

10 ! THIS PROGRAM LOADS 00010000 00000000 BINARY INTO THE ISCE
20 PRINT @6, "ISCE 4096" ! LOAD DECIMAL 4096 INTO ISCE
30 PRINT @6, "ISCE?" ! READ BACK ISCE VALUE
40 INPUT @6, A% ! "
50 PRINT "ISCE = ";A% ! PRINT IT, IT SHOULD BE 4096
60 END

```

5-56. Output Queue

The output queue is loaded whenever a query is processed, and holds up to 800 characters. The controller reads it with a statement such as a BASIC INPUT statement, removing what it reads from the queue. If the queue is empty, the 5820A Calibrator does not respond to the INPUT statement from the controller. The Message Available (MAV) bit in the Serial Poll Status Byte is 1 if there is something in the output queue and 0 if the output queue is empty.

5-57. Error Queue

When a command error, execution error, or device-dependent error occurs, its error code is placed in the error queue where it can be read by the ERR? command. (See Appendix F for a list of error messages.) A way to decode an error code is to send the command, EXPLAIN?, which returns a description of a error code. Reading the first error with the ERR? command removes that error from the queue. A response of 0 means the error queue is empty. The Error Available (EAV) bit in the Serial Poll Status Byte indicates whether the queue is empty. The error queue is cleared when you turn off the power, and when you use the *CLS (Clear Status) common command.

The error queue contains up to 16 entries. If many errors occur, only the first 15 errors are kept in the queue. A 16th entry in the queue is always an "error queue overflow" error, and all later errors are discarded until the queue is at least partially read. The first errors are kept, because if many errors occur before the user can acknowledge and read them, the earliest errors are the most likely to point to the problem. The later errors are usually repetitions or consequences of the original problem.

5-58. Remote Program Examples

The following programming examples illustrate ways to handle errors, to take measurements, take a number of successive readings, lock the range, and calibrate the calibrator. These excerpts from programs are written in DOS BASIC.

5-59. Guidelines for Programming the Calibrator

Commands are processed one at a time as they are received. Some commands require a previous condition be set before the command will be accepted by the 5820A Calibrator. Using the following programming guidelines will insure that the output is programmed to the desired state.

- The SCOPE command should be programmed first.
- The output should be programmed next with the OUT command.
- All other output parameters such as offset and waveform should be programmed next.
- The error status should be checked with the ERR? command. The calibrator will not process the OPER command if an unacknowledged error exists.
- Finally, the calibrator should be placed in operate with the OPER command.

A controller program first needs to initialize the interface and the 5820A Calibrator. Refer to following sample program:

```
10 INIT PORT 0 \ REMOTE @6           ! PUT THE 5820A INTO THE
                                     ! REMOTE STATE
20 PRINT @6, "*RST;SCOPE VOLT; OUT 1v, 0HZ;;OPER" ! RESET THE 5820A,
                                     ! PROGRAM IT TO OUTPUT
                                     ! 1 V DC
```

If you wish to use SRQs, first use the *SRE, *ESE, and ISCE commands to enable the desired event. Refer to "Checking 5820A Status."

You retrieve instrument parameters with a query (a programming command that ends with a question mark):

```

200 PRINT @6, "FUNC?"           ! RETRIEVE OUTPUT FUNCTION
210 INPUT LINE @6, A$
220 PRINT "Function is: "; A$
230 PRINT @6, "ONTIME?"        ! RETRIEVE ON TIME
240 INPUT LINE @6, A$
250 PRINT "The instrument has been on for "; A$;" hours"

```

This program generates the following sample output:

```

Function is: DCV
The instrument has been on for 0 days, 02:23:58 hours

```

Check for programming errors as in the following sample programs. Check the Error Available (EAV) bit in the serial poll register using a serial poll.

```

300 A = SPL(6)                 ! CHECK FOR ERRORS
310 IF (A AND 8) THEN PRINT "There was an error"
320 PRINT @6, "*CLS"           ! CLEAR ERRORS

```

Retrieve errors and explanations as follows. Since errors are accumulated in a queue, you must read the entire queue to retrieve and clear all the errors.

```

400 PRINT @6, "ERR?"          ! CHECK FOR ERRORS
410 INPUT @6, A, A$           ! READ IN THE ERROR
420 IF (A = 0) THEN GOTO 500  ! NO MORE ERRORS
430 PRINT "Error# :";A, A$    ! PRINT ERROR# AND EXPLANATION
440 GOTO 400
500 END

```

5-60. Writing an SRQ and Error Handler

It is good practice to include fault (error) handling routines in your applications. The following sample program lines show a method for halting program execution on occurrence of an SRQ (Service Request) on the bus, checking to see if the calibrator is the source of the SRQ, retrieving its fault messages, and acting on the faults. You should modify and extend this code as necessary for your application.

If you want to use SRQs, first use the *SRE, *ESE, and ISCE commands to enable the desired event. Refer to "Checking 5820A Status" for more information.

```

10  INIT PORT0                 ! IFC the bus
20  CLEAR PORT0               ! DCL the bus
30  ! INITIALIZE THE 5820A SRQ HANDLER
40  PRINT @6, "*SRE 8"        ! Enable STB.EAV (error available)
50  ON SRQ GOTO 1100         ! Install SRQ handler
60  ! Body of the application goes here
1100 ! Bus SRQ handler
1110 CLEAR PORT0             ! Make sure devices are not confused
1120 IF (SPL(6) AND 64) THEN GOSUB 1200 ! If (STB.RQS) call SRQ
1130 ! TEST OTHER DEVICES RQS BITS IF DESIRED
1140 RESUME
1200 ! 5820A SRQ handler
1210 IF (SPL(6) AND 8) THEN GOSUB 1300 ! If (STB.EAV) call handler
1220 ! Test other STB bits if desired here
1299 RETURN
1300 ! 5820A STB.EAV (error) handler
1320 PRINT @6, "ERR?"        ! Read and clear error
1330 INPUT @6, E%, E$        ! Read in error # and explanation
1340 PRINT "Error# :";E, E$  ! Print error # and explanation
1350 IF (E% <> 0) THEN GOTO 1320 ! Until no more errors
1360 STOP                    ! Other commands for your app
1370 END

```

5-61. Using *OPC?, *OPC, and *WAI

The *OPC?, *OPC, and *WAI commands let you maintain control of the order of execution of commands that could otherwise be passed up by subsequent commands.

If you had sent an OUT command, you can check if the output has settled by sending the query *OPC?. As soon as the OUT command has completed (output settled), a "1" appears in the output buffer. You should always follow an *OPC? command with a read command. The read command causes program execution to pause until the addressed instrument responds. The following sample program shows how you can use *OPC?.

```

10 PRINT @4, "OUT 1V,1KHZ;OPER; *OPC?" ! 5820A ADDRESS IS 4
20 INPUT @4, A ! READ THE "1" FROM THE 5820A
30 !PROGRAM HALTS HERE UNTIL A "1" IS PUT INTO THE OUTPUT BUFFER
40 PRINT "OUTPUT SETTLED"

```

The *OPC command is similar in operation to the *OPC? query, except that it sets bit 0 (OPC for "Operation Complete") in the Event Status Register to 1 rather than sending a 1 to the output buffer. One simple use for *OPC is to include it in the program in order for it to generate an SRQ (Service Request). Then an SRQ handler written into the program can detect the operation complete condition and respond appropriately. You can use *OPC similarly to *OPC?, except your program must read the ESR to detect the completion of all operations. The following sample program shows how you can use *OPC.

```

10 REMOTE
20 PRINT @4, "OUT 1V,1KHZ;OPER;*OPC" ! 5820A ADDRESS IS 4
30 PRINT @4, "*ESR?" ! PUT THE ESR BYTE IN BUFFER
40 INPUT @4, A% ! READ THE ESR BYTE
50 IF (A% AND 1%) = 0% GOTO 30 ! TRY AGAIN IF NO OPC
60 PRINT "OUTPUT SETTLED"
70 END

```

The *WAI command causes the 5820A Calibrator to wait until any prior commands have been completed before continuing on to the next command, and takes no other action. Using *WAI is a convenient way to halt operation until the command or commands preceding it have completed. The following sample program shows how you can use *WAI.

```

10 REMOTE
20 PRINT @4, "OUT 100V,1KHZ;OPER;*WAI" ! 5820A ADDRESS IS 4
30 PRINT @4, "OUT?" ! READ THE OUTPUT VALUE
40 PRINT @4, A$,B$,C$ ! A$ CONTAINS THE OUTPUT VALUE
50 PRINT "OUTPUT SETTLED"
60 PRINT "OUTPUT IS: ";A$;B$;" at ";C$
70 END

```

5-62. Taking an Impedance Measurement

The following program takes one measurement at a time.

```

10 REM Set Bus Timeout to 20 seconds, Init IEEE Bus
20 TIMEOUT 20 * 1000
30 INIT PORT 0
40 CLEAR @6
100 REM Reset 5820A, impedance measurement mode
110 PRINT @6,"*RST; SCOPE MEASZ; RANGE TZ50OHM"
200 PRINT "Hit Carriage Return to take a Reading"
210 INPUTLINE A$
220 REM Trigger and wait for measurement
230 PRINT @6, "*TRG"
240 REM Read measurement, unit
250 INPUT @6, M,U$
260 GOTO 200

```

5-63. Using the RS-232 UUT Port to Control an instrument

The SERIAL 2 TO UUT RS-232 port is used to pass commands on to another instrument. For example, a meter that is being calibrated can have its RS-232 port connected to the calibrator SERIAL 2 TO UUT serial port. Commands sent from a controller can be routed through the calibrator's UUT port and received by the meter or UUT. There are six special UUT_* commands incorporated into the calibrator for passing commands on to an instrument connected to the UUT port. Refer to Chapter 6 for more information.

5-64. Input Buffer Operation

As the 5820A Calibrator receives each data byte from the controller, it places the bytes in a portion of memory called the input buffer. The input buffer holds up to 350 data bytes and operates in a first in, first out fashion.

IEEE-488 The 5820A Calibrator treats the EOI IEEE-488 control line as a separate data byte and inserts it into the input buffer if it is encountered as part of a message terminator. Input buffer operation is transparent to the program running on the controller. If the controller sends commands faster than the calibrator can process them, the input buffer fills to capacity. When the input buffer is full, the calibrator holds off the IEEE-488 bus with the NRFD (Not Ready For Data) handshake line. When the calibrator has processed a data byte from the full input buffer, it then completes the handshake, allowing the controller to send another data byte. The calibrator clears the input buffer on power-up and on receiving the DCL (Device Clear) or SDC (Selected Device Clear) messages from the controller.

RS-232 Under RS-232-C serial port remote control using ^S (<Cntl> S) XOFF protocol, the calibrator issues a ^S XOFF when the input buffer becomes 80 % full. The calibrator issues a ^Q (<Cntl> Q) when it has read enough of the input buffer so that it is less than 40 % full. When using RTS (Request to Send) protocol (selected as part of the "RS-232 Host Port Setup Procedure"), the serial interface asserts and unasserts RTS in response to same conditions as for XON/XOFF protocol.

Chapter 6

Remote Codes

	Title	Page
6-1.	Introduction.....	6-3
6-2.	Command Summary by Function	6-3
6-3.	Summary of Commands and Queries	6-8

6-1. Introduction

This chapter documents the IEEE-488/RS-232 remote commands for the 5820A Calibrator. Remote commands duplicate activities that can be initiated from the front panel in local operation. Table 6-1 summarizes the commands by function. Following the summary table is a complete alphabetical listing of all commands complete with protocol details. Separate headings in the alphabetical listing provide the parameters and responses, plus an example for each command. For information on using commands, see Chapter 5.

6-2. Command Summary by Function

Note

The following commands are not useful over the remote interface, but are provided to imitate the front panel more completely.

Table 6-1. Command Summary by Function

Error Mode Commands	
EDIT	Sets the edit field. PRI is specified for the output value in single output functions and the primary output value in dual output functions.
EDIT?	Returns the edit field setting.
ERR_UNIT	Choose how UUT error is shown.
ERR_UNIT?	Return presently selected value of ERR_UNIT.
INCR	Increments or decrements the output (as selected by the edit field) and enters error mode, the same as using the output adjustment knob in local operation.
MULT	Multiplies the reference magnitude (as selected by the edit field).
NEWREF	Sets the reference value to be the present 5820A output value, the same as pressing the NEW REF key in local operation.
OLDREF	Sets the 5820A output to the previously programmed reference value, the same as pressing the ENTER key in local operation.
OUT_ERR?	Returns the UUT error computed by the 5820A after shifting the output with the INCR command.
REFOUT?	Returns the value of the reference, which is the output values of the 5820A the last time a new reference was established with an OUT, NEWREF, or MULT.

Table 6-1. Command Summary by Function (cont.)

Common Commands	
*CLS	(Clear status.) Clears the ESR, ISCR0, ISCR1, the error queue, and the RQS bit in the status byte. This command terminates pending operation complete commands (*OPC or *OPC?).
*ESE	Loads a byte into the Event Status Enable register.
*ESE?	Returns the contents of the Event Status Enable register.
*ESR?	Returns the contents of the Event Status Register and clears the register.
*IDN?	Identification query. Returns instrument model number, serial number, and firmware revision levels for the main, front panel, and inguard.
*OPC	Enables setting of bit 0 (OPC for "Operation Complete") in the Event Status Register to 1 when all pending device operations are complete.
*OPC?	Returns a 1 after all pending operations are complete. This commands causes program execution to pause until all operations are complete. (See also *WAI.)
*OPT?	Returns a list of the installed hardware and software options, including any 5725A Amplifiers that are attached.
*PUD	Protected user data command. This command allows you to store a string of bytes in nonvolatile memory. This command works only when the CALIBRATION switch is in the ENABLE position.
*PUD?	Returns the contents of the *PUD (Protected User Data) memory.
*RST	Reset. Resets the state of the instrument to the power-up state. This command holds off execution of subsequent commands until it is complete. (Overlapped command.)
*SRE	Loads a byte into the Service Request Enable register (SRE).
*SRE?	Returns the byte from the Service Request Enable register.
*STB?	Returns the status byte.
*TST?	Initiates a series of self-tests, then returns a "0" for pass or a "1" for fail. If any faults are detected, they are logged into the fault queue where they can be read by the ERR? query.
*WAI	Wait-to-Continue command. This command prevents further remote commands from being executed until all previous remote commands have been executed.

Table 6-1. Command Summary by Function (cont.)

Output Commands	
FUNC?	Returns the present calibration function.
OL_TRIP?	Returns the detected state of scope overload protection.
OPER	Activates the 5820A output if it is in standby.
OPER?	Returns the operate/standby setting.
OUT	Sets the output of the 5820A and establishes a new reference point for the error mode.
OUT?	Returns the output amplitudes and frequency of the 5820A.
OUT_IMP	Sets the output impedance of the SCOPE BNC.
OUT_IMP?	Returns the output impedance of the SCOPE BNC.
RANGE	Programs the range in PULSE, MEAS Z, and OVERLD modes.
RANGE?	Returns the present output ranges.
RANGELCK	Locks in the present range, or selects auto ranging.
RANGELCK?	Returns whether or not the preset output range is locked.
SCOPE	Sets the calibrator output to an oscilloscope mode.
SCOPE?	Returns the present oscilloscope mode.
STBY	Puts the 5820A in standby.
TDPULSE	Turns the tunnel diode pulse drive on or off in EDGE mode.
TLIMIT	Sets the OPERATE time limit for the OVERLD mode signal.
TLIMIT?	Returns the OPERATE time limit for the OVERLD mode signal.
TMWAVE	Selects the waveform for MARKER mode.
TMWAVE?	Returns the MARKER mode waveform setting.
*TRG	Triggers and returns a new impedance measurement.
TRIG	Sets the divider (and location if the 5-channel option is installed) of the signal at the TRIG OUT BNC.
TRIG?	Returns the divider (and location if the 5-channel option is installed) of the signal at the TRIG OUT BNC.
TRIGSKEW	Sets the skew between the trigger and the pulse outputs.
TRIGSKEW?	Returns the skew value between the trigger and pulse outputs.
VAL?	Returns the last impedance measurement value.
VIDEOFMT	Selects the format for VIDEO mode.
VIDEOFMT?	Returns the VIDEO mode format.
VIDEOMARK	Programs the VIDEO mode line marker location.
VIDEOMARK?	Returns the VIDEO mode line marker location.
WAVE	Sets the waveform for wavegen output.
WAVE?	Returns the waveform of the output.
ZERO_MEAS	Sets the measurement offset to the capacitance value.

Table 6-1. Command Summary by Function (cont.)

RS-232 Host Port Commands	
LOCAL	Puts the 5820A into the local state.
LOCKOUT	Puts the 5820A into the lockout state. This command duplicates the IEEE-488 LLO (Local Lockout) message.
REMOTE	Puts the 5820A into the remote state. This command duplicates the IEEE-488 REN (Remote Enable) message.
SPLSTR	Sets the serial remote mode Serial Poll response string.
SPLSTR?	Returns the string programmed for serial remote mode Serial Poll responses.
SRQSTR	Sets the serial remote mode SRQ (Service Request) response (up to 40 characters).
SRQSTR?	Returns the string programmed for Serial Mode SRQ response.
^P (<cntl>p)	Control-P character prints the serial poll string. (See SPLSTR for string format.)
^C (<cntl>c)	Control-C character clears the device.
^T (<cntl>t)	Control-T character executes a group trigger.
Setup and Utility Commands	
FORMAT	Use with extreme care. Restores the contents of the nonvolatile memory device to factory defaults.
ONTIME?	Returns the time since the 5820A was powered up last.
PR_RPT	Prints the Stored, Active, or CAL_Report through either the HOST or the UUT Serial Port.
SP_SET	Sets the RS-232-C serial port settings and saves them in nonvolatile memory. The settings apply only to HOST port.
SP_SET?	Returns the HOST serial port settings contained in nonvolatile memory.
TLIMIT_D	Sets the default OPERATE time limit for the OVERLD mode signal.
TLIMIT_D?	Returns the default overload time limit.
ERR_UNIT	Chooses how the UUT error is shown.
ERR_UNIT?	Returns presently selected values of ERR_UNIT.

Table 6-1. Command Summary by Function (cont.)

Status Commands	
ERR?	Returns the first error code contained in the 5820A error queue, then removes that error code from the queue.
EXPLAIN?	Explains an error code. This command returns a string that explains the error code furnished as the parameter.
FAULT?	Returns the first error code contained in the 5820A error queue, then removes that error from the queue.
ISCE	Loads two bytes into both the Instrument Status 1 to 0 Change Enable register and the Instrument Status 0 to 1 Change Enable register.
ISCE?	Returns the OR of the contents of the Instrument Status 1 to 0 Change Enable register and the Instrument Status 0 to 1 Change Enable register.
ISCE0	Loads two bytes into the Instrument Status 1 to 0 Change Enable register.
ISCE0?	Returns the contents of the Instrument Status 1 to 0 Change Enable register.
ISCE1	Loads two bytes into the Instrument Status 0 to 1 Change Enable register.
ISCE1?	Returns the contents of the Instrument Status 0 to 1 Change Enable register.
ISCR?	Returns the OR of the contents of the Instrument Status 1 to 0 Change Register and the Instrument Status 0 to 1 Change Register and clears both registers.
ISCR0?	Returns and clears the contents of the Instrument Status 1 to 1 Change Register.
ISCR1?	Returns and clears the contents of the Instrument Status 0 to 0 Change Register.
ISR?	Returns the contents of the Instrument Status Register.
RS-232 UUT Port Commands	
UUT_FLUSH	Flush the UUT receive buffer.
UUT_RECV?	Return data from the UUT serial port.
UUT_SEND	Sends a string to the UUT serial port.
UUT_SET	Sets the UUT serial port settings and saves them in nonvolatile memory.
UUT_SET?	Returns the UUT serial port settings contained in nonvolatile memory.

6-3. Summary of Commands and Queries

The following is an alphabetical list of all 5820A Calibrator commands and queries, including common commands and device-dependent commands. Each command title includes a graphic that indicates remote interface applicability, IEEE-488 and RS-232, and command group: Sequential, Overlapped, and Coupled.

IEEE-488 (GPIB) and RS-232 Applicability Each command and query has a check box indicating applicability to IEEE-488 (general purpose interface bus, or GPIB) and RS-232 remote operations. For sorting purposes, this list ignores the * character that precedes the common commands.

Sequential Commands Commands executed immediately as they are encountered in the data stream are called sequential commands. Anything not overlapped or coupled is sequential. For more information, see Chapter 5.

Overlapped Commands Commands that require additional time to execute are called overlapped commands because they can overlap the next command before completing execution. To be sure an overlapped command is not interrupted during execution, use the *OPC, *OPC?, and *WAI commands to detect command completion. For more information, see Chapter 5.

Coupled Commands The commands OUT, WAVE, and DC_OFFSET, are coupled commands because they “couple” in a compound command sequence. Care must be taken to be sure the action of one command does not disable the action of a second command and thereby cause a fault. For more information, see Chapter 5.

CAL_ABORT

(IEEE-488, RS-232, Overlapped)

(Calibration Abort query) Instructs 5820A to abort calibration procedure after present step.

Example: CAL_ABORT

CAL_BACKUP

(IEEE-488, RS-232, Overlapped)

Skips to the next entry point in the calibration procedure.

CAL_CONST?

(IEEE-488, RS-232)

(Calibration Constant command/query) Retrieves the value in use of the given calibration constant.

Parameter: The name of the calibration constant

Response: (float) The value of the constant

Example: CAL_CONST? VDAC_G

CAL_DATE?

(IEEE-488, RS-232)

(Calibration Date command) Returns date associated with active calibration constants as entered on the front panel or entered with the CAL_STORE command.

Parameter: MAIN, OPT5, and GHZ

Example: CAL_DATE? MAIN

CAL_FACT

(IEEE-488, RS-232)

(Calibration Fact command) Sets the procedure “fault action” flag.

Parameter: (char) CONT to continue on faults or ABORT to abort on faults)

Example: CAL_FACT ABORT (this is the default)

CAL_FACT?

(IEEE-488, RS-232)

(Calibration Fact query) Gets the procedure “fault action” flag.

Response: (char) CONT or ABORT or BACKUP (BACKUP backs up to previous entry)

Example: ABORT

CAL_FAULT?

(IEEE-488, RS-232)

(Calibration Fault query) Gets information about calibration error (if one occurred).

Response: 1. error number (use EXPLAIN? command to interpret)
2. name of step where error occurred

CAL_INFO?

(IEEE-488, RS-232)

(Calibration Information query) Returns message or instructions associated with running step.

Response: (string) the message string

CAL_NEXT

(IEEE-488, RS-232, Overlapped)

(Calibration Next command) Continues a calibration procedure if it is waiting.

Parameter: (Optional) Reference value (used if it's waiting for a reference). If the reference value has no unit, the unit is assumed to be that returned by the CAL_REF? command.

Example: CAL_NEXT
CAL_NEXT 2.999987

CAL_REF?

(IEEE-488, RS-232)

(Calibration Reference query) Returns nominal value expected for reference entry.

Response: 1. the nominal value
2. the accepted or implied unit

Example: 3.000000e+00,V

CAL_SKIP

(IEEE-488, RS-232, Overlapped)

Skips to the next entry point in calibration procedure.

CAL_SECT

(IEEE-488, RS-232, Overlapped)

Skips to the next section of the calibration procedure.

CAL_START

(IEEE-488, RS-232, Overlapped)

(Calibration Start command) Starts a calibration procedure.

Parameter: 1. Procedure name (MAIN or OPT5):

MAIN is the procedure for the 5800 .

OPT5 is available if you have the 5-channel option

2. (Optional) name of the step at which to start.

If this parameter is not provided, it starts at the beginning.

Example: CAL_START MAIN

CAL_STATE?

(IEEE-488, RS-232)

(Calibration State query) Returns state of calibration.

Response: RUN - running a calibration step.

REF - waiting for a CAL_NEXT with reference (measurement) value.

INS - instruction available, waiting for a CAL_NEXT.

NOT - not in a calibration procedure (or at end of one).

ADJ - waiting for a CAL_NEXT after output is adjusted to match something.

CAL_STEP?

(IEEE-488, RS-232)

(Calibration Step query) Returns name of step currently running.

Response: (chart) The step name

Example: IDAC_RATIO (running IDAC ratio calibration)

NOT (not running a calibration procedure now)

CAL_STORE

(IEEE-488, RS-232)

(Calibration Store command) Stores new calibration constants (CAL switch must be ENABLED).

CAL_STORE?

(IEEE-488, RS-232)

(Calibration Store query) Returns whether a cal store is needed.

Response: 1 is yes, 0 if no

CAL_SW?

(IEEE-488, RS-232)

(Calibration Switch query) Returns the setting of the calibration enable switch.

Response: (integer) 1 for enable, 0 for normal

Example: 1

CCO?

(IEEE-488, RS-232)

Same as CAL_CONST?

CHAN

(IEEE-488, RS-232, Overlapped, Coupled)

Selects the output channel.

Parameter: C1, C2, C3, C4, or C5

CHAN?

(IEEE-488, RS-232)

Returns the output channel.

Parameter: C1, C2, C3, C4, or C5

CLOCK

(IEEE-488, RS-232)

Sets the real time clock. The time may be set whenever desired. To set the date, the CALIBRATION switch must be set in the ENABLE position.

Parameter:

1. (int) year	(1992-2091 valid)
2. (int) month	(1 - 12)
3. (int) day	(1 - 31)
4. (int) hour	(0 - 23)
5. (int) minute	(0 - 59)
6. (int) second	(0 - 59)

OR

1. (int) hour	(0 - 23)
2. (int) minute	(0 - 59)
3. (int) second	(0 - 59)

CLOCK?

(IEEE-488, RS-232)

Returns the date and item according to the real time clock.

Parameter: None

Response: In ISO 8601 format. e.g. 1999-09-19, 21:53:26

****CLS***

(IEEE-488, RS-232)

(Clear Status command) Clears the ESR, ISCR0, ISCR1, the error queue, and the RQS bit in the status byte. This command terminates pending operation complete commands (*OPC or *OPC?).

Parameter: (None)

Example: *CLS

D_SP_SET

(IEEE-488, RS-232)

Temporarily sets the host serial settings until reset.

D_UUTSET

(IEEE-488, RS-232)

Temporarily sets the UUT serial settings until reset.

DC_OFFSET

(IEEE-488, RS-232, Overlapped, Coupled)

Applies a dc offset to an ac signal in WAVEGEN mode only.

Parameter: Offset amplitude with optional multiplier and voltage unit.

Example: DCOFFSET 1.44 MV.

DC_OFFSET?

(IEEE-488, RS-232)

Returns the dc offset voltage.

Response: (Float) signed offset amplitude.

Example: +1.44E-03 (1.44 mV)
+0.00E-03 (No dc offset)

EDIT

(IEEE-488, RS-232)

(Edit command) Sets the edit field. PRI is specified for the output value in single output functions and the primary output value in dual output functions. SEC is specified for the secondary value in dual output functions. FREQ is specified for the frequency in single ac output functions. The frequency cannot be edited in dual ac output functions. EDIT OFF is the same as using the NEWREF command.

Parameters: PRI (edit the value in single output functions and the pulse width in PULSE mode)
SEC (edit the pulse period in PULSE mode)
FREQ (edit the frequency value in single ac output functions)
OFF (edit is off, which is the same as using the NEWREF command)

Example: EDIT FREQ

Load FREQ into the edit field to edit frequency.

A zero value is returned when the error queue is empty. To read the entire contents of the error queue, repeat ERR? until the response 0, "No Error" is returned. For terminal users, the error queue return for ERR? is always 0, "No Error" because error messages are returned instead of queued.

Response: <value>, (error code value)
<string> (text string explaining the error)

Example: ERR? returns 0, "No Error"

Return 0, "No Error" when the error queue is empty.

ERR_UNIT

(IEEE-488, RS-232, Overlapped)

(UUT Error Unit Thresh Hold command) Chooses how UUT error is shown (this in nonvolatile).

Parameter:	GT1000	UUT error is displayed in % above 1000 ppm, ppm below
	GT100	UUT error is displayed in % above 100 ppm, ppm below
	GT10	UUT error is displayed in % above 10 ppm, ppm below
	PPM	UUT error is displayed in ppm always
	PCT	UUT error is displayed in % always

ERR_UNIT?

(IEEE-488, RS-232)

(UUT Error Unit Thresh Hold query) Returns presently selected values of ERR_UNIT as one of the choices.

Responses:	GT1000	UUT error is displayed in % above 1000 ppm, ppm below
	GT100	UUT error is displayed in % above 100 ppm, ppm below
	GT10	UUT error is displayed in % above 10 ppm, ppm below
	PPM	UUT error is displayed in ppm always
	PCT	UUT error is displayed in % always

***ESE**

(IEEE-488, RS-232)

(Event Status Enable command) Loads a byte into the Event Status Enable (ESE) register. (See Chapter 5 for more information.)

Parameter: <value> (decimal equivalent of the 8-bit binary number to load into the register.)

Example: *ESE 140

Enables bits 2 (QYE), 3 (DDE), and 7 (PON), and disables all the other bits.

ESE?

(IEEE-488, RS-232)

(Event Status Enable query) Returns the contents of the Event Status Enable (ESE) register. (See Chapter 5 for more information.)

Parameter: None

Response: (Integer) Decimal equivalent of the register byte.

Example: *ESE?

Returns "140" if bits 2 (QYE), 3 (DDE), and 7 (PON) are enabled (1) and the rest of the bits are disabled (0).

***ESR?**

(IEEE-488, RS-232)

(Event Status Register query) Returns the contents of the Event Status Register (ESR) and clears the register. (See Chapter 5 for more information.)

Response: (Integer) Decimal equivalent of the register byte.

Example: *ESR?

Returns "140" if bits 2 (QYE), 3 (DDE), and 7 (PON) are set (1) and the rest of the bits are reset (0).

EXPLAIN?

(IEEE-488, RS-232)

(Explain Error query) Explains an error code. This command returns a string that explains the error code furnished as the parameter. The error code (same as the parameter) is originally obtained by sending the FAULT? query. (See the ERR? command, which returns both the error code and the explanation string.) See Appendix F for a list of error codes and error messages.

Parameter: <value> if the error code (an integer)

Response: <string> that explains the error code, with the parameter (if there is one) shown as a percent sign followed by d (integer parameter), f (floating point parameter), or s (string parameter)

Example: EXPLAIN? 539 returns "Can't change compensation now."

Return the explanation of error 539: "Can't change compensation now."

FASTEDG

(IEEE-488, RS-232, Overlapped, Coupled)

[ON or OFF] Set the output to the 150 ps edge rise time (normally off)- EDGE mode only.

Note

FASTEDG and TDPULSE cannot both be on. Turning one on automatically shuts the other off.

FAULT?

(IEEE-488, RS-232)

*Note**This is provided for 5700A compatibility. ERR? is preferred.*

(Fault query) Returns the first error code contained in the 5820A Calibrator error queue, then remove that error from the queue. After obtaining the error code, use the EXPLAIN? command to view an explanation. A zero value is returned when the error queue is empty. To read the entire contents of the error queue, repeat FAULT? until the response is 0. (Only system errors appear in the error queue.)

Response: <value> of the error code

Example: FAULT? returns 539

Return the first error code in the error queue, number 539. To view an explanation of the error, enter the command EXPLAIN? 539.

FORMAT

(IEEE-488, RS-232)

(Format command) Use with extreme care. Restores the contents of the nonvolatile memory device to factory defaults. The memory holds calibration constants and setup parameters. You lose all calibration data permanently. The CALIBRATION switch on the rear panel of the 5820A Calibrator must be set in the ENABLE position or an execution error occurs, except for FORMAT SETUP.

Parameter: ALL (replaces the whole contents with factory defaults)
 CAL (replaces all cal constants with factory defaults)
 SETUP (replaces setup parameters with factory defaults)

Example: FORMAT SETUP

Replace the setup parameters with the default setup values (below). (The FORMAT ALL command is the same as FORMAT CAL and then FORMAT SETUP.) The FORMAT SETUP command also clears the *PUD string (see the *PUD command) and SRQSTR is set to "SRQ: %02x %02x %04x %04x" (see the SRQSTR command) and SPLSTR is set to "SPL: %02x %02x %04x %04x" (see the SPLSTR command).

Features			
Host Connection	gpiib (IEEE-488)	Display Brightness*	level 1,0
GPIB Port Address	8	EOL (end of line)	CRLF
Serial Ports	8 bits, 1 stop bit, xon/xoff, parity none, 9600 baud, wait 30 sec.	Remote I/F	term
Remote commands			
SRQSTR	SRQ: %02x %02x %04x %04x	*PUD string	cleared
* Output Display and Control Display, respectively. There are 8 levels: 0,1,2,3,4,5,6,7.			

FUNC?

(IEEE-488, RS-232)

(Function query) Returns the present output, measurement, or calibration function. See the response below for output & measurement modes.

Responses:

SACV	(oscilloscope ac volts function)
SDCV	(oscilloscope dc volts function)
SDORM	(no function active)
WAVEGEN	(oscilloscope wave generating function)
VIDEO	(oscilloscope video function)
OVERLD	(oscilloscope overload function)
MEAS Z	(oscilloscope measure capacitance/impedance function)
AUXIN	(oscilloscope auxiliary input function)
PULSE	(oscilloscope pulse function)
MARKER	(oscilloscope marker function)
LEVSINE	(oscilloscope leveled sine function)
EDGE	(oscilloscope edge function)
SDCI	(dc current)
SACI	(ac current)
MEASV	(measure voltage)

Example: FUNC? returns SACV

***IDN?**

(IEEE-488, RS-232)

(Identification query.) Returns instrument model number, serial number and firmware revision levels for the main, and front panel CPUs.

Response: (Indefinite ASCII) A message containing five fields separated by commas as follows:

1. Manufacturer (FLUKE)
 2. Model number (5820A)
 3. Serial number
 4. Firmware revision level for the Main CPU
 5. Firmware revision level for the Front Panel CPU
 6. Firmware revision level for the Inguard PGA
-

INCR

(IEEE-488, RS-232, Overlapped)

(Increment command) Increments or decrements the output (as selected using the EDIT command) and enters error mode; the same as using the output adjustment knob in local operation.

Parameters: Increment step size; positive for incremental step, negative for decremental step. Units (optional) specify magnitude. The units must match those units in the selected edit field.

Example: INCR -.00001 mV

Enter the error mode and decrement the output by .00001.

ISCE

(IEEE-488, RS-232)

(Instrument Status Change Enable command) Loads two bytes into the two 16-bit ISCE mask registers (ISCE1 and ISCE0). (See Chapter 5 for more information.)

Parameter: <value> (decimal equivalent of the 16 bits, 0 to 32767)

Example: ISCE 4108

Load decimal 4108 (binary 0001000000001100) to enable bit 12 (SETTLED). This is equivalent to sending the commands ISCE0 4108 and ISCE1 4108 (see below).

ISCE?

(IEEE-488, RS-232)

(Instrument Status Change Enable query) Returns the two bytes from the two 16-bit ISCE mask registers (ISCE1 and ISCE0). (See Chapter 5 for more information.)

Response: <value> (decimal equivalent of the 16 bits, 0 to 32767)

Example: ISCE? returns 4108

Return decimal 4108 (binary 0001000000001100) if bit 12 (SETTLED) is set to 1.

ISCE0

(IEEE-488, RS-232)

(Instrument Status 0 to 1 Change Enable command) Loads the two bytes into the 16-bit ISCE0 register. (See Chapter 5 for more information.)

Parameter: <value> (decimal equivalent of the 16 bits, 0 to 32767)

Example: ISCE0 4108

Load decimal 4108 (binary 0001000000001100) to enable bit 12 (SETTLED).

ISCE0?

(IEEE-488, RS-232)

(Instrument Status 0 to 1 Change Enable query) Returns the two bytes from the 16-bit ISCE0 register. (See Chapter 5 for more information.)

Response: <value> (decimal equivalent of the 16 bits, 0 to 32767)

Example: ISCE0? returns 4108

Return decimal 4108 (binary 0001000000001100) if bit 12 (SETTLED) is set to 1.

ISCE1

(IEEE-488, RS-232)

(Instrument Status 1 to 0 Change Enable command) Loads the two bytes into the 16-bit ISCE1 register. (See Chapter 5 for more information.)

Parameter: <value> (decimal equivalent of the 16 bits, 0 to 32767)

Example: ISCE1 4108

Load decimal 4108 (binary 0001000000001100) to enable bit 12 (SETTLED).

ISCE1?

(IEEE-488, RS-232)

(Instrument Status 1 to 0 Change Enable query) Returns the two bytes from the 16-bit ISCE1 register. (See Chapter 5 for more information.)

Response: <value> (decimal equivalent of the 16 bits, 0 to 32767)

Example: ISCE1? returns 4108

Return decimal 4108 (binary 0001000000001100) if bit 12 (SETTLED) is set to 1.

ISCR?

(IEEE-488, RS-232)

(Instrument Status Change Register query) Returns and clears the contents of the Instrument Status 0 to 1 Change Register (ISCR0) and Instrument Status 1 to 0 Change Register (ISCR1). (See Chapter 5 for more information.)

Response: <value> (decimal equivalent of the 16 bits, 0 to 32767)

Example: ISCR? returns 4108

Return decimal 4108 (binary 0001000000001100) if bit 12 (SETTLED) is enabled (set to 1) in the Instrument Status 0 to 1 Change Register and bit 12 (SETTLED) is enabled (set to 1) in the Instrument Status 1 to 0 Change Register.

ISCR0?

(IEEE-488, RS-232)

(Instrument Status 0 to 1 Change Register query) Returns and clears the contents of the Instrument Status 0 to 1 Change Register.

Response: <value> (decimal equivalent of the 16 bits, 0 to 32767)

Example: ISCR0? returns 4108

Return decimal 4108 (binary 0001000000001100) if bit 12 (SETTLED) is set to 1.

ISCR1?

(IEEE-488, RS-232)

(Instrument Status 1 to 0 Change Register query) Returns and clears the contents of the Instrument Status 1 to 0 Change Register.

Response: <value> (decimal equivalent of the 16 bits, 0 to 32767)

Example: ISCR1? returns 4108

Return decimal 4108 (binary 0001000000001100) if bit 12 (SETTLED) is set to 1.

ISR?

(IEEE-488, RS-232)

(Instrument Status Register query) Returns contents of the Instrument Status Register.

Response: <value> (decimal equivalent of the 16 bits, 0 to 32767)

Example: ISR? returns 4108

Return decimal 4108 if bit 12 (SETTLED) is set to 1.

LOCAL

(RS-232)

(Local command) Puts the 5820A Calibrator into the local state, clearing the remote state (see the REMOTE command) and front panel lockout (see the LOCKOUT command). This command duplicates the IEEE-488 GTL (Go To Local) message.

Parameter: (None)

Example: LOCAL

Set the instrument into the local state, clearing the remote state and front panel lockout (if enable).

LOCKOUT

(RS-232)

(Lockout command) Puts the 5820A Calibrator into the lockout state when in remote control (see the REMOTE command). This means no local operation at the front panel is allowed during remote control. To clear the lockout condition, use the LOCAL command. This command duplicates the IEEE-488 LLO (Local Lockout) message.

Parameter: (None)

Example: LOCKOUT

Set the instrument into the front panel lockout state. The front panels controls cannot be used.

MEAS_OFFSET?

(IEEE-488, RS-232)

Returns the capacitance measurement offset (in farads).

MULT

(IEEE-488, RS-232, Overlapped)

(Multiply command) Multiplies the reference magnitude (as selected with the EDIT command). The reference magnitude is the present output in direct mode and the reference in error mode.

Parameter: Floating point number acts as a multiplier.

Example: MULT 1.9

If the output is 10 V with error mode off and you send the command, "MULT 1.9," the output changes to 19 V.

NEWREF

(IEEE-488, RS-232)

(New Reference command) Sets the new reference to be the present 5820A Calibrator output value and exit the error mode (if selected). For example, you might edit the 5820A Calibrator output using the EDIT and INCR commands, and then use the NEWREF command to establish a new reference point and exit the error mode. This is the same as pressing the 5820A Calibrator front panel  key.

Parameter: (None)

Example: NEWREF

Set the reference value to the current 550A Calibrator output value.

OLDREF

(IEEE-488, RS-232, Overlapped)

(Old Reference command) Sets the 5820A Calibrator output to the previously programmed reference value and exit the error mode (if selected). This is the same as pressing the  key in local operation.

Parameter: (None)

Example: OLDREF

Set the output to the existing reference value, clearing editing changes.

OL_TRIP?

(IEEE-488, RS-232)

Returns the detected state of scope overload protection.

Parameters: (None)

Response: Returns the number of seconds before protection was tripped. Returns 0 if protection has not been tripped or if OVERLD mode not active.

ONTIME?

(IEEE-488, RS-232)

(Calibrator On Time query) Returns the time since the 5820A Calibrator was most recently powered up.

Response: <days>,<hours> (24-hour clock)

Example: ONTIME? returns 5 DAYS, 19:57:45

Return the time since the 5820A Calibrator was last powered up: 5 days, 19 hours, 57 minutes and 45 seconds.

*Note**Resetting the clock alters the ONTIME? results.*

***OPC**

(IEEE-488, RS-232)

(Operations Complete command) Enables setting of bit 0 (OPC for "Operation Complete") in the Event Status Register to 1 when all pending device operations are complete.

Parameter: (None)

Example: *OPC

Set bit 0 of the Event Status Register to 1 when all pending device operations are done.

***OPC?**

(IEEE-488, RS-232)

(Operations Complete query) Returns a 1 after all pending operations are complete. This command causes program execution to pause until all operations are complete. (See also *WAI.)

Response: 1 (all operations are complete)

Example: *OPC? returns 1

Return 1 when all pending operations are complete.

OPER

(IEEE-488, RS-232, Overlapped)

(Operate command) Activate the 5820A Calibrator output if it is in standby. If there are errors in the error queue, the OPER command is inhibited for outputs 33 V rms and over. (Also see the ERR? command and STBY command.)

Parameter: (None)

Example: OPER

Connect the selected output to the 5820A Calibrator front panel terminals.

OPER?

(IEEE-488, RS-232)

(Operate query) Return the operate/standby setting.

Response: 1 (Operate)
 0 (Standby)

Example: OPER? returns 1

Return 1 when the 5820A Calibrator is in operate.

***OPT?**

(IEEE-488, RS-232)

Returns a list of the installed hardware and software options, including any auxiliary amplifiers that are attached.

Responses: <option string>,<option string>,... (options list, separated by commas)
 0 (no options are installed)

Example: 0

OUT

(IEEE-488, RS-232, Overlapped, Coupled)

Sets the output of the 5820A Calibrator and establishes a new reference point for the error mode. If the frequency is not supplied, the 5820A Calibrator will use the frequency that is presently in use. One amplitude or the frequency must be supplied. (Overlapped command.)

Use multipliers e.g., k, M, μ with the OUT command, as desired.

Parameters: <value> V	Volts dc or update volts ac
<value> DBM mode only)	Volts ac dBm update (LEVSINE)
<value> V, <value> HZ	Volts ac or volts dc with 0 Hz
<value> DBM, <value> HZ	Volts ac in dBm
<value> HZ	Update frequency
<value> S	Pulse width
<value> S, <value> S	Pulse width or update pulse width
<value> S, <value> HZ	Pulse width or update period
<value> PCT	Update percentage
<value> HZ, <value> S	Period or update pulse width
<value>	For single output, changes amplitude keeping unit and frequency the same.
<value>A	Amps dc
<value>A, <value>HZ	Amps ac

Examples:

VOLT, EDGE, LEVSINE, and WAVEGEN modes:

OUT 1.2 V, 1 kHz	output 1.2 V, 1 kHz
OUT 8 kHz	output 8 kHz, same amplitude as before
OUT 0 Hz	output dc, same amplitude as before
OUT 1 V	output 1 V, same frequency as before

(The frequencies have to differ for LEVSINE, its minimum being 50 kHz)

MARKER mode:

OUT 1 ms	output 1 millisecond time marker
OUT 1 kHz	same thing

VIDEO mode:

OUT 100 pct	output 100 % (1 V) video signal
OUT 1 V	same thing

PULSE mode:

OUT 100 ns,1 μ	output 100 nanosecond width pulse, 1 microsecond period
OUT 100 ns,1MHz	output 100 nanosecond width pulse, 1 microsecond period
OUT 100 ns	output 100 nanosecond width pulse, same period as before
OUT 1 MHz	output 1 microsecond period, same pulse width as before

OVERLD mode:

OUT 5 V	output 5 V ac or dc signal, depending on RANGE selection
---------	--

Each example shows a value and unit, e.g., -15.2 V. If a value is entered without a unit, the value of the existing output is changed, when logically allowed.

OUT?

(IEEE-488, RS-232)

Returns the output amplitudes and frequency of the 5820A Calibrator. Multipliers (e.g., K or M) are not used in the response.

Response: <primary amplitude value>,<primary units>,
 <secondary amplitude value>,<secondary units>,
 <fundamental frequency value>

Examples:

-1.520000E+01,V,+0.000000E+00,00.000E+00 (-15.2V)
 +1.883000E-01,A,+0.000000E+00,04.420E+02 (188.3 mA, 442 Hz)

OUT_ERR?

(IEEE-488, RS-232)

(Output Error query) Returns the UUT error and units computed by the 5820A Calibrator after shifting the output with the INCR command. The UUT error is computed only when editing VOLTAGE mode amplitude and MARKER period.

Response: 1. (Float) UUT error magnitude
 2. (Character) Units for the above number (PPM, PCT, DB, or 0)

Example: OUT_ERR? returns -1.00000E+01,PCT

Return -10 % when the UUT is reading low by 10 %.

OUT_IMP

(IEEE-488, RS-232, Overlapped, Coupled)

Programs the oscilloscope's output impedance. The scope output impedance is selectable only in the volt scope mode.

Parameters: Z50 (Programs the oscilloscope's output impedance to 50 Ω.)
 Z1M (Programs the oscilloscope's output impedance to 1 MΩ.)

Example: OUT_IMP Z50

OUT_IMP?

(IEEE-488, RS-232)

Returns the impedance setting of the oscilloscope's output.

Parameters: (None)

Response: (Character) Z50 or Z1M

PR_PRT X IEEE X RS-232

Prints a self-calibration report out the selected serial port.

Parameters:

1. Type of report to print: STORED, ACTIVE, or CONSTS
2. Format of report: PRINT (designed to be read), SPREAD (designed to be loaded into a spreadsheet)
3. Calibration interval to be used for instrument specification in the report: 190D (90 day spec), 11Y (1 year spec)
4. Serial port through which to print: HOST, UUT

Example: PR_PRT STORED, PRINT, 190D, HOST

***PUD**

(IEEE-488, RS-232)

(Protected User Data command) Protected user data command. This command allows you to store a string of bytes in nonvolatile memory. This command works only when the CALIBRATION switch is in the ENABLE position.

Parameter: #2<nn><nn characters string> (definite length)
 #0<character string> (indefinite length)
 "<character string>" (character string)

Example: Binary Block Data

*PUD #0CAL LAB NUMBER 1\<Line Feed with EOF>

or

*PUD #216CAL LAB NUMBER 1

Note

*The 2 indicates that there is are two digits to follow (in this case "16"), and the 16 indicates that there are 16 characters including space characters in the remainder of the *PUD message (in this case "CAL LAB NUMBER 1")*

This type of data is called Binary Block Data in the IEEE-488.2 Standard. In the 5820A, you may also use String Data. The parameter "CAL LAB NUMBER 1" works exactly the same.

***PUD?**

(IEEE-488, RS-232)

Returns the contents of the *PUD (Protected User Data) memory.

Response: (Binary Block) The maximum response is 64 characters.

Example: *PUD? returns #216CAL LAB NUMBER 1

Assuming that this is stored as in the example for *PUD above.

RANGE

(IEEE-488, RS-232, Coupled, Overlapped)

Explicitly programs the instrument range in PULSE, MEAS Z, OVERLD modes. It provides functionality similar to the range or amplitude select softkeys in those modes.

Parameters:

The range name, from the following choices (by mode):

Pulse	TP8DB	TP20DB	TP28DB	TP40DB	TP48DB
Range	1.5 V	600 mV	150 mV	60 mV	15 mV

Impedance Measure	TZ50OHM	TZ1MOHM	TZCAP
Range	res 50Ω	res 1MΩ	cap

Overload	TOLDC	TOLAC
Range	dc signal	1 kHz squarewave, ac signal

Example: RANGE TP20DB

RANGE?

(IEEE-488, RS-232)

Returns the present output ranges.

Parameter: None

Response: 1. (Character) Symbolic name of the range of single or first output.
2. (Character) Symbolic name of the range of second output (0 if no second output).

RANGELCK

(IEEE-488, RS-232, Overlapped)

(Range Lock command) Locks in the present range or selects auto ranging for leveled sine mode. The range automatically unlocks if the output function changes. When RANGELCK is on, this is equivalent to the softkey range lock showing locked. When RANGELCK is off, this is equivalent to the softkey range lock showing auto.

Parameter: ON (Locks the range)
OFF (Unlocks the range for autoranging)

Example: RANGELCK OFF

RANGELCK?

(IEEE-488, RS-232)

(Range Lock query) Returns whether or not the preset output range is locked.

Response: ON (range is locked and autoranging is not allowed)
OFF (range is not locked and autoranging is allowed)

REF10MHZ

(IEEE-488, RS-232, Overlapped command)

(Leveled Sine Mode 10 MHz Reference Frequency Toggle)

Parameters: ON or 1 Toggles to 10 MHz reference frequency.
OFF or 0 Toggle to previously programmed frequency.

REF10MHZ?

(IEEE-488, RS-232, Sequential)

(Leveled Sine 10 MHz Reference query) Interrogates calibrator whether 10 MHz is engaged.

Parameters: ON engaged
OFF not engaged

REFCLOCK

(IEEE-488, RS-232, Overlapped)

(Reference Clock) Sets the reference clock source. This is a nonvolatile setup parameter.

Parameter: INT (Sets the internal reference clock)
EXT (Sets the external reference clock)

REFCLOCK?

(IEEE-488, RS-232)

Returns the reference clock source.

Response: (Character) INT (Reference clock is internal)
EXT (Reference clock is external)

REFOUT?

(IEEE-488, RS-232)

(Reference Output query) Returns the present value of the reference which is the output values of the 5820A the last time a new reference was established with an OUT, NEWREF, or MULT. This applies only to VOLTAGE and MARKER mode.

Response: (Float) Reference amplitude

Example: REFOUT? returns 0E+00

Return 0 when the output is not being edited.

Example: REFOUT? returns 2.500000E-01

Return .250 when the output is being edited and the reference is, for example, 250 mV.

REMOTE

(RS-232)

(Remote command) Places the 5820A Calibrator into the remote state. This command duplicates the IEEE-488 REN (Remote Enable) message. When in the remote state, the Control Display shows the softkey “REMOTE CONTROL Go to Local.” Pressing this softkey returns the 5820A Calibrator to local operation. If the front panel is locked out, the Control Display shows the softkey “REMOTE CONTROL LOCAL LOCK OUT.” (See the LOCKOUT command.) To unlock the front panel, use the LOCAL command, or cycle the 5820A Calibrator power switch.

Parameter: (None)

Example: REMOTE

Place the 5820A Calibrator in the remote state and display this state on the front panel Control Display with a softkey REMOTE CONTROL.

***RST**

(IEEE-488, RS-232, Overlapped)

(Reset Instrument command) Reset the 5820A Calibrator to the power-up state. *RST holds off execution of subsequent commands until the reset operation is complete. This command is the same as pressing the front panel R key.

A reset action evokes the following commands and values:

Command	Value	Command	Value
STBY	(No output)	TRIG	OFF
OUT	0 V, 0 HZ	OVLD	10 s
DC_OFFSET	0 V	OUT_CHAN	1
VIDEOFMT	NTSC	TRIG_CHAN	5
VIDEOMKR	line 10	OUTPUT	20 mV
TRIGLMT	10 s	SCOPEMODE	V
RANGELCK	OFF	TDPULSE	OFF
MARKER	spike	SCOPE	OFF
WAVEGEN	square	OUT_IMP	Z1M

Leveled Sine goes to “jump” at a rate of 1 MHz. Refer to Chapter 4 for more information. Changes made to the setup menus that are not saved in memory are discarded on reset.

Response: (None)

Example: *RST

Place the 5820A Calibrator in a reset condition, evoking the commands and values shown above.

SCOPE

(IEEE-488, RS-232, Overlapped command)

Selects the scope mode.

Table 6-2. SCOPE Command Parameters

Parameter	Description/Example
VOLT	Oscilloscope ac and dc VOLT mode. Programs 20 mV peak-to-peak, 1 kHz, output at the SCOPE BNC, output impedance 1 M Ω , standby if from OFF or previously in standby. FUNC? returns SACV (for ac) or SDCV (for dc).
	Example: SCOPE VOLT; OUT 4 V, 1 kHz (ac voltage, 4 V peak-to-peak, 1 kHz.)
EDGE	Oscilloscope EDGE mode. Programs 20 mV peak-to-peak, 1 MHz, output at the SCOPE BNC, standby if from OFF or previously in standby. FUNC? returns EDGE.
	Example: SCOPE EDGE; OUT 0.5 V, 5 kHz (Edge, 0.5 V peak-to-peak, 5 kHz.)
LEVSINE	Oscilloscope LEVSINE mode. Programs 30 mV peak-to-peak, 50 kHz, output at the SCOPE BNC, standby if from OFF or previously in standby. FUNC? returns LEVSINE.
	Example: SCOPE LEVSINE; OUT 1 V, 50 kHz (Leveled sine wave, 1 V peak-to-peak, 50 kHz.)
MARKER	Oscilloscope MARKER mode. Programs the period to 1 ms, output at the SCOPE BNC, standby if from OFF or previously in standby. FUNC? returns MARKER.
	Example: SCOPE MARKER; OUT 2 ms (Marker, period of 2 ms.)
WAVEGEN	Oscilloscope WAVEGEN mode. Programs 20 mV peak-to-peak, square wave, 1 kHz, no offset, output impedance 1 M Ω , standby if from OFF or previously in standby. FUNC? returns WAVEGEN.
	Example: SCOPE WAVEGEN; OUT 1 V, 1 kHz (Wave Generator, 1 V peak-to-peak, 1 kHz.)
VIDEO	Oscilloscope VIDEO mode. Programs 100 % output (1 V p/p), line marker 10, format NTSC. FUNC? returns VIDEO.
	Examples: SCOPE VIDEO; OUT 90PCT (Video, 90 % output) SCOPE VIDEO; OUT -70PCT (Video, -70 % output, inverse video)

Table 6-2. SCOPE Command Parameters (cont.)

Parameter	Description/Example
PULSE	Oscilloscope PULSE mode. Programs 100 ns pulse width, 1.000 μ s period, 2.5V range. FUNC? returns PULSE.
	Example: SCOPE PULSE; OUT 50 ns, 500 ns; RANGE TP8DB (Pulse, 50 ns pulse width, 500 ns period, 1.5 V range)
MEASZ	Oscilloscope Impedance/Capacitance measurement (MEAS Z) mode. Programs 50 Ω range. FUNC? returns MEASZ.
	Example: SCOPE MEASZ; RANGE TZCAP (MEAS Z mode, capacitance range)
MEASV	Measure DC voltage at the terminals (at the required range)
OVERLD	Oscilloscope Overload mode. Programs 5 V dc range. FUNC? returns OVERLD.
	Example: SCOPE OVERLD; OUT 7 V; RANGE TOLAC (Overload, 7 V output, ac range)
AMP	Source Current at the frequency (0 = DC) and amplitude specified. Note defaults are AMP = 100uA and FREQ = 1kHz
AUXIN	Oscilloscope AUXIN mode: Passed auxiliary input through to selected output channel.

Example:

SCOPE VOLT; OUT -2 V, 0HZ	(dc voltage, -2 V)
SCOPE VOLT; OUT 2 V, 1KHZ	(ac voltage, 2 V peak-to-peak, 1 kHz)
SCOPE LEVSINE; OUT 5 V, 60KHZ	(Leveled sine, 5 V peak-to-peak, 60 kHz)
SCOPE MARKER; OUT 2MS	(Marker, period of 2 ms)
SCOPE EDGE; OUT .5 V, 5KHZ	(Edge, .5 V peak-to-peak, 5 kHz)
SCOPE WAVEGEN; OUT 1V, 10KHZ; WAVE TRI	(Wave gen, triangle wave 1 V pp)
SCOPE VIDEO; OUT 50 PCT; VIDEOFMT PAL; VIDEOMARK 150	(Video, PAL format, 50 % video signal, mark at line 150)
SCOPE PULSE; OUT 5 NS, 10US; RANGE TP8DB	(Pulse, 5 ns width, 10 μ s period, 1.5 V amplitude)
SCOPE MEASZ; RANGE TZCAP	(Capacitance measurement)
SCOPE OVERLD; RANGE TOLAC; OUT 8V	(Overload test, 8 V pp ac signal)
SCOPE MEASV	(Voltage Measurement)
SCOPE AMP; OUT 1MA, 1KHZ AC CURRENT, 1MA PEAK TO PEAK, 1KHZ	

SCOPE?

(IEEE-488, RS-232)

Returns the oscilloscope's current mode of operation. Returns OFF if the oscilloscope is off.

Parameter: (None)

Response: <character> (Returns OFF, VOLT, EDGE, LEVSINE, MARKER, WAVEGEN, VIDEO, PULSE, MEASZ, or OVERLD.)

SP_SET

(RS-232)

(Host Serial Port Set command) Sets the RS-232-C settings for the 5820A Calibrator rear panel SERIAL 1 FROM HOST serial port, which is saved in the 5820A non-volatile memory. (While saving configuration data in the non-volatile memory, a period of about 2 seconds, the 5820A does not respond to remote commands.) (To set the parameters for the rear panel SERIAL 2 TO UUT serial port, see the UUT_SET command.) The factory default values are shown below in bold type. (To return to the factory defaults, see the FORMAT SETUP command.)

The interface selection sets the command response, with command echo back for commands and error messages with TERM (terminal) or no echo back with COMP (computer).

Parameters: <baud rate value>, 300, 600, 1200, 2400, 4800, 9600
 <interface>, TERM (terminal), COMP (computer)
 <flow control>, XON (xon/xoff), NOSTALL (none), RTS (rts/cts)
 <number data bits>, DBIT7 (7 bits) or DBIT8 (8 bits)
 <number stop bits>, SBIT1 (1 bit) or SBIT2 (2 bits)
 <parity>, PNONE (none), PODD (odd), PEVEN (even)
 <end of line char.> CR (carriage return), LF (line feed),
 CRLF (carriage return/line feed)

Example: SP_SET 9600,TERM,XON,DBIT8,SBIT1,PNONE,CRLF

Set the parameters for the rear panel SERIAL 1 FROM HOST serial port to the factory default values.

SP_SET?

(RS-232)

(Host Serial Port Set query) Returns the RS-232-C settings for the 5820A Calibrator rear panel SERIAL 1 FROM HOST serial port. (To return the parameters for the rear panel SERIAL 2 TO UUT serial port, see the UUT_SET? command.) The factory default values are shown below in bold type. (To return to the factory defaults, see the FORMAT SETUP command.)

Responses: <baud rate value>, 300, 600, 1200, 2400, 4800, 9600
 <interface>, TERM (terminal), COMP (computer)
 <flow control>, XON (xon/xoff), NOSTALL (none), RTS (rts/cts)
 <number data bits>, DBIT7 (7 bits) or DBIT8 (8 bits)
 <number stop bits>, SBIT1 (1 bit) or SBIT2 (2 bits)
 <parity>, PNONE (none), PODD (odd), PEVEN (even)
 <end of line char.> CR (carriage return), LF (line feed),
 CRLF (carriage return/line feed)

Example: SP_SET? returns 9600,TERM,XON,DBIT8,SBIT1,PNONE,CRLF

Return the parameters for the rear panel SERIAL 1 FROM HOST serial port, as shown, when set to the factory default values.

SPLSTR

(IEEE-488, RS-232)

(Serial Poll String command) Sets the Serial Poll String (string up to 40 characters) which is saved in the 5820A non-volatile memory. (While saving configuration data in the non-volatile memory, a period of about 2 seconds, the 5820A does not respond to remote commands.) The SPLSTR is sent to the host over the serial interface when a ^P (<cntl> P) character is sent. The default format is:

SPL: %02x %02x %04x %04x

where the term %02x (8 bits) means print the value in hexadecimal with exactly 2 hex digits, and %04x (16 bits) means print the value in hexadecimal with exactly 4 hex digits. The string representations are:

SPL: (STB) (ESR) (ISCR0) (ISCR1)

See the commands, respectively, *STB?, *ESR?, ISCR0?, and ISCR1?. A typical string in the default format sent to the host is: SPL: 44 00 0000 1000. This command is for format. For values instead of format, enter a ^P (<cntl> p) character. Also see the SRQSTR command.

Parameter: “<string>\n” (\n represents the NEWLINE character, hex 0A)

Example: SPLSTR “SPL: %02x %02x %04x %04x\n”

Set the SPLSTR to the default values SPL: %02x %02x %04x %04x\n.

SPLSTR?

(IEEE-488, RS-232)

(Serial Poll Response String query) Returns the string programmed for Serial Poll response. For values, enter a ^P (<cntl> p) character. Also see the SRQSTR command.

Response: <string>

Example: SRQSTR returns SRQ: %02x %02x %04x %04x\n

Return the SPLSTR string format (default settings in this example).

***SRE**

(IEEE-488, RS-232)

(Service Request Enable command) Loads a byte into the Service Request Enable (SRE) register. (See Chapter 5 for more information. Since bit 6 is not used (decimal value 64), the maximum entry is $255 - 64 = 191$.)

Parameter: <value> (The decimal equivalent of the binary number to load into the register.)

Example: *SRE 56

Enable bits 3 (IIR), 4 (MAV), and 5 (ESR).

***SRE?**

(IEEE-488, RS-232)

(Service Request Enable query) Returns the byte in the Service Request Enable (SRE).

Response: <value> ((Integer) The decimal equivalent of the register byte.)

Example: *SRE? returns 56

Return 56 when bits 3 (EAV), 4 (MAV), and 5 (ESR) are enabled (1) and the rest of the bits are disabled (0).

SRQSTR

(IEEE-488, RS-232)

(Service Request String command) Sets the Serial Mode SRQ (Service Request) response (up to 40 characters) in the 5820A non-volatile memory. (While saving configuration data in the non-volatile memory, a period of about 2 seconds, the 5820A does not respond to remote commands.) The SRQSTR is sent to the host over the serial interface when the SRQ line is asserted (terminal mode only). Default format is:

SRQ: %02x %02x %04x %04x

where the term %02x (8 bits) means print the value in hexadecimal with exactly 2 hex digits, and %04x (16 bits) means print the value in hexadecimal with exactly 4 hex digits. The string representations are:

SRQ: (STB) (ESR) (ISCR0) (ISCR1)

See the commands, respectively, *STB?, *ESR?, ISCR0?, and ISCR1? A typical string in the default format sent to the host is: SRQ: 44 00 0000 1000. This command is for format. See the SPLSTR command for the serial poll response.

Parameter: “<string>\n” (\n represents the Line Feed character, hex 0A)

Example: SRQSTR “SRQ: %02x %02x %04x %04x\n”

Set the SRQSTR to the default values SRQ: %02x %02x %04x %04x\n.

SRQSTR?

(IEEE-488, RS-232)

(Service Request String query) Returns the string programmed for Serial Mode SRQ response. This is the format of the Service Request String; actual values come from the registers. Also see the SPLSTR command.

Response: <string>

Example: SRQSTR returns SRQ: %02x %02x %04x %04x\n

Return the SRQSTR string format (default settings in this example).

***STB?**

(IEEE-488, RS-232)

(Status Byte Register command) Returns the byte for the Status Byte Register. (See Chapter 5 for more information.)

Response: <value> (the decimal equivalent of the status byte)

Example: *STB? returns 72

Return 72 if bits 3 (EAV) and 6 (MSS) are set (1) and the rest of the bits are reset (0).

STBY

(IEEE-488, RS-232, Overlapped)

(Standby command) Deactivates the 5820A Calibrator output if it is in operate.

Parameter: (None)

Example: STBY

Disconnect the selected output from the 5820A Calibrator front panel terminals.

TDPULSE

(IEEE-488, RS-232, Overlapped, Coupled)

Turns tunnel diode pulser drive on/off in EDGE mode.

Parameters: ON (or non-zero) or OFF (or zero)

Example: TDPULSE ON

Returns the tunnel diode pulse drive setting in EDGE mode.

Parameters: None

Response: 1 if ON, 0 if OFF.

Note

FASTEDG and TDPULSE cannot both be on. Turning one on automatically shuts the other off.

TDPULSE?

(IEEE-488, RS-232)

Returns the tunnel diode pulser drive setting.

Response: 1 if ON, 0 if OFF

TLIMIT

(IEEE-488, RS-232)

Sets the OPERATE time limit for the OVERLD mode signal. The Calibrator automatically returns to STANDBY if the UUT protection trips within this interval or at the end of this interval if the protection has not tripped.

Parameters: 1 to 60 (seconds)

Example: TLIMIT 30

TLIMIT?

(IEEE-488, RS-232)

Returns the programmed OPERATE time limit for the OVERLD mode signal.

Response: <Integer> Time limit in seconds.

TLIMIT_D

(IEEE-488, RS-232)

Sets the default OPERATE time limit for the OVERLD mode signal. At the end of the specified interval, the instrument will automatically to STANDBY.

Parameters: 1 to 60 (seconds)

Example: TLIMIT_D 15

TLIMIT_D?

(IEEE-488, RS-232)

Returns the default overload time limit.

Response: <Integer> Default time limit in seconds.

TMWAVE

(IEEE-488, RS-232, Coupled, Overlapped)

Selects the waveform for MARKER mode.

Parameters:	SINE	Sine wave (2 ns to 15 ns)
	SPIKE	Triangular/sawtooth pulse (15 ns to 5s)
	SQUARE	Square wave (50 % duty cycle) (4 ns to 5s)
	SQ20PCT	Square wave (20 % duty cycle) (85 ns to 5s)

Example: TMWAVE SPIKE

TMWAVE?

(IEEE-488, RS-232)

Returns the MARKER mode waveform setting.

Parameters: None

Response: <character> (Returns SINE, SPIKE, SQUARE, or SQ20PCT.)

***TRG**

(IEEE-488, RS-232)

Triggers and returns a new impedance measurement value when used in MEAS Z mode.

Responses: <measurement value>, OHM (input impedance value in ohms)
 <measurement value>, F (input capacitance value in farads)
 <measurement value>, NONE (no measurement is available)

Example: *TRG returns 1.00E+03,OHM (1 k Ω input impedance).

Note

*You can also use the VAL? query to return an impedance measurement value. VAL? returns the last measurement, whereas *TRG gets a new measurement. Responses are the same as shown above for the *TRG command.*

TRIG

(IEEE-488, RS-232, Overlapped, Coupled)

Programs the oscilloscope's trigger output BNC. The oscilloscope trigger output is only available in the MARKER, VOLT, PULSE, and EDGE modes.

Parameters: OFF (Turns the trigger output off.)
 DIV1 (Turns the trigger output on. Frequency is the same as the signal at SCOPE output.)
 DIV10 (Turns the trigger output on. Frequency is 1/10 of the signal at SCOPE output.)
 DIV100 (Turns the trigger output on. Frequency is 1/100 of the signal at SCOPE output.)

Example: TRIG DIV10

TRIG?

(IEEE-488, RS-232)

Returns the output setting of the oscilloscope's trigger.

Parameters: (None)

Response: <character> (Returns OFF, DIV1, DIV10, or DIV100.)

TRIG_CHAN

(IEEE-488, RS-232, Overlapped, Coupled)

Selects the output channel.

Parameters C 1 or C5

TRIG_CHAN?

(IEEE-488, RS-232)

Returns the output channel.

Response: C1 or C5

TRIGSKEW

(IEEE-488, RS232, Overlapped, and Coupled)

Set the trigger skew for pulse output. (PULSE mode)

Parameter: <value> of the skew in seconds. A positive value means the trigger leads the output pulse.

Example: TRIGSKEW 10.0ns

Sets the trigger to lead the pulse by 10 nano-seconds

TRIGSKEW?

(IEEE-488 AND RS232)

Return the present setting of the trigger skew for pulse output.

Response: <value> of the skew in seconds.

Example: TRIGSKEW? returns -2.00e-8

Trigger lags the pulse by 20 nano-seconds.

***TST?**

(IEEE-488, RS-232)

(Self Test command) Initiates self-test and return a 0 for pass or a 1 for fail. If any faults are detected, they are logged into the fault queue where they can be read by the ERR? query (computer mode).

Response: 0 (pass self test)

1 (fail self test)

Example: *TST? returns 1

Return 1 when self test is successful.

UUT_FLUSH

(IEEE-488, RS-232)

(Flush UUT Receive Buffer command) Flushes the UUT receive buffer for data received from the UUT over the 5820A Calibrator rear panel SERIAL 2 TO UUT serial port. The command may be sent over gpib or RS-232 ports, but applies to SERIAL 2 TO UUT serial port operation.

Parameter: (None)

Example: UUT_FLUSH

Flush the 5820A Calibrator receive data buffer for the UUT.

UUT_RECV?

(IEEE-488, RS-232)

(Return UUT Receive Data command) Returns data from the UUT serial port. The command may be sent over gpib or RS-232 ports, but applies to SERIAL 2 TO UUT serial port operation.

Response: (String) Data from the UUT serial port.

Example: UUT_RECV? returns #211+1.99975E+0

Return (for example) a measurement from the UUT. The format is #2 (two numbers follow) 11 (characters follow) +1.99975E+0 (11 characters).

UUT_RECVB?

(IEEE-488, RS-232)

Returns binary data as integers from the UUT serial port.

Parameter: (Integer) Optional maximum number of integers per line

Response: (Indefinite ASCII) Comma separated integers as follows:

1. (Integer) Number of data bytes being returned not including the count
- 2-n. (Integer) Data from the UUT serial port as integers.

Example: In a Fluke 45 is hooked up to the UUT port and it returns => followed by a carriage return and a line feed, UUT_RECVB will return 4, 61, 62, 13, 10.

UUT_SEND

(IEEE-488, RS-232)

(Send UUT Data command) Sends data to the UUT serial port in binary block or string data format over the 5820A Calibrator rear panel SERIAL 2 TO UUT serial port. The command may be sent over gpib or RS-232 ports, but applies to SERIAL 2 TO UUT serial port operation. Include a line feed (RS-232) character to terminate the block data or End or Identify (EOI) command (IEEE-488).

Parameter: #2<nn><nn characters string> (definite length)
 #0<character string> (indefinite length)
 "<character string>" (character string)

Examples:

UUT_SEND #206F1S2R0 (definite length format)

Send the data F1S2R0 to the UUT in definite length format. The format is #2 (two numbers follow) 06 (characters follow) F1S2R0 (6 characters).

UUT_SEND #0F1S2R0 (indefinite length format)

Send the data F1S2R0 to the UUT in indefinite length format. The format is #0 then the characters.

UUT_SEND "F1S2R0" (character string)

Send the data F1S2R0 to the UUT as a character string.

Special Case When the character string sent to a UUT must end in a carriage return (CR) command or line feed (LF) command or both, you must use the following:

Definite Length Format Follow the instructions above and after the character string add a command ^J for CR or ^M for LF or both, where ^J means hold down the <Cntl> key and type the letter J. For example, sending the string REMS in this format with both CR and LF, you would count 4 characters for REMS and 1 character each for ^J and ^M for a total of 6 characters. The command would be UUT_SEND #206REMS^J^M then <enter>. (The ^J and ^M "characters" actually perform the CR and LF functions.)

Indefinite Length Format This format may not be used when a character string requires CR and LF commands.

Character String Follow the instructions above and after the character string, add a \n for CR or \r for LF or both, where the alpha character is entered in lower case. For example, in the terminal mode to send the string REMS in this format with both CR and LF, the command would be UUT_SEND "REMS\n\r". In the computer mode where commands are entered as part of a command string, use double quotes to show embedded quotes. For example, "uut_send ""REMS\n\r"" "

The following characters and commands may be implemented as described above:

Carriage Return	^J	\n
Line Feed	^M	\r
Tab	Tab	\t
Backspace	^H	\b
Form Feed	^L	\f

UUT_SENDB

(IEEE-488, RS-232)

Sends binary data as integers to the UUT serial port.

Parameter: 1 to 10 (Integer) Integers to send to the UUT port.

Example: To send “*IND?” followed by a new line (ASCII 10), use:
 UUTSENDB 42, 73, 68, 78, 63, 10

UUT_SET

(IEEE-488, RS-232)

(UUT Serial Port Set command) Sets the RS-232-C settings for the 5820A Calibrator rear panel SERIAL 2 TO UUT serial port, which is saved in the 5820A non-volatile memory. (While saving configuration data in the non-volatile memory, a period of about 2 seconds, the 5820A does not respond to remote commands.) (To set the parameters for the rear panel SERIAL 1 FROM HOST serial port, see the SP_SET command.) The factory default values are shown below in bold type. (To return to the factory defaults, see the FORMAT SETUP command.)

The interface selection sets the command response, with command echo back with TERM (terminal) and no echo back with COMP (computer).

Parameters: <baud rate value>, 300, 600, 1200, 2400, 4800, 9600
 <flow control>, XON (xon/xoff), NOSTALL (none), RTS (rts/cts)
 <number data bits>, DBIT7 (7 bits) or DBIT8 (8 bits)
 <number stop bits>, SBIT1 (1 bit) or SBIT2 (2 bits)
 <parity> PNONE (none), PODD (odd), PEVEN (even)

Example: UUT_SET 9600,XON,DBIT8,SBIT1,PNONE

Set the parameters for the rear panel SERIAL 2 TO UUT serial port to the factory default values.

UUT_SET?

(IEEE-488, RS-232)

(UUT Serial Port Set query) Returns the RS-232-C settings for the 5820A Calibrator rear panel SERIAL 2 TO UUT serial port. (To return the parameters for the rear panel SERIAL 1 FROM HOST serial port, see the SP_SET? command.) The factory default values are shown below in bold type. (To return to the factory defaults, see the FORMAT SETUP command.)

Responses: <baud rate value>, 300, 600, 1200, 2400, 4800, 9600
 <flow control>, XON (xon/xoff), NOSTALL (none), RTS (rts/cts)
 <number data bits>, DBIT7 (7 bits) or DBIT8 (8 bits)
 <number stop bits>, SBIT1 (1 bit) or SBIT2 (2 bits)
 <parity> PNONE (none), PODD (odd), PEVEN (even)

Example: UUT_SET? returns 9600,XON,DBIT8,SBIT1,PNONE

Return the parameters for the rear panel SERIAL 2 TO UUT serial port, as shown, when set to the factory default values.

VAL?

(IEEE-488, RS-232)

Returns an impedance measurement value. VAL? returns the last measurement, whereas *TRG gets a new measurement.

Responses: <measurement value>, OHM (input impedance value in ohms)
 <measurement value>, F (input capacitance value in farads)
 <measurement value>, NONE (no measurement is available)

Example: VAL? returns 1.00E+03,OHM (1 k Ω input impedance).

VIDEOFMT

(IEEE-488, RS-232, Overlapped, Coupled,)

Selects the format for VIDEO mode. (Coupled, Overlapped command.)

Parameters: NTSC, PAL, PALM (for PAL-M), or SECAM

Example: VIDEOFMT SECAM

VIDEOFMT?

(IEEE-488, RS-232)

Returns the VIDEO mode format.

Parameters: None

Response: NTSC, PAL, PALM (for PAL-M), or SECAM

VIDEOMARK

(IEEE-488, RS-232, Overlapped, Coupled,)

Programs the VIDEO mode line marker location. To select a line in the even frame for NTSC or PAL-M, add 262 to the line number. (Coupled, Overlapped command.)

Parameters: (number) Line marker location.

Example: VIDEOFMT NTSC; VIDEOMARK 272 (line 10, even frame)
 VIDEOFMT PALM; VIDEOMARK 75 (line 75, odd frame)
 VIDEOFMT PAL; VIDEOMARK 413 (line 413)

VIDEOMARK?

(IEEE-488, RS-232)

Returns the VIDEO line marker location.

Parameters: None.

Response: (number) Line marker location.

***WAI**

(IEEE-488, RS-232)

(Wait-to-Continue command) Prevents further remote commands from being executed until all previous remote commands have been executed. For example, if you send an OUT command, you can cause the 5820A Calibrator to wait until the output has settled before continuing on to the next command if you follow OUT with a *WAI command. The *WAI command is useful with any overlapped command, preventing the 5820A Calibrator from processing other commands until the overlapped command is processed.

Example: *WAI

Process all existing commands before continuing.

WAVE

(IEEE-488, RS-232, Overlapped, Coupled)

(Waveform command) Sets the output waveforms for WAVEGEN mode. Waveform choices are SINE (sinewave), TRI (trianglewave), SQUARE (squarewave), or NONE (waveform does not apply).

Parameter: <waveform> ,(SINE, TRI, SQUARE, NONE)

Example: WAVE SINE

WAVE?

(IEEE-488, RS-232)

(Waveform query) Returns the output waveform. Waveform choices are SINE (sinewave), TRI (trianglewave), SQUARE (squarewave), or NONE (waveform does not apply).

Responses: < waveform> , (SINE, TRI, SQUARE, NONE)

Example: WAVE? returns SQUARE

Return SQUARE when the WAVEGEN ac primary output is a squarewave.

ZERO_MEAS

(IEEE-488, RS-232, Overlapped)
(in MEASV mode, TZCAP range)

Sets the measurement offset to the capacitance value to the most recent measurement if ON, to zero if OFF.

Parameters: (boolean) ON or OFF.

Chapter 7

Maintenance

	Title	Page
7-1.	Introduction.....	7-3
7-2.	Replacing the Line Fuse	7-3
7-3.	Cleaning the Air Filter	7-4
7-4.	General Cleaning	7-6
7-5.	Verification Tables	7-6
7-6.	DC Voltage Output Verification	7-6
7-7.	AC Voltage Amplitude Verification.....	7-7
7-8.	AC Voltage Frequency Verification.....	7-8
7-9.	DC Voltage Measurement Verification.....	7-8
7-10.	Wave Generator Amplitude Verification: 1 M Ω Output Impedance	7-9
7-11.	Wave Generator Amplitude Verification: 50 Ω Output Impedance.	7-10
7-12.	Wave Generator Frequency Verification: 1 M Ω Output Impedance	7-11
7-13.	Leveled Sinewave Verification: Amplitude	7-11
7-14.	Leveled Sinewave Verification: Frequency	7-11
7-15.	Leveled Sinewave Verification: Harmonics.....	7-12
7-16.	Leveled Sinewave Verification: Flatness	7-13
7-17.	Edge Verification: Amplitude	7-19
7-18.	Edge Verification: Frequency.....	7-19
7-19.	Edge Verification: Duty Cycle	7-19
7-20.	Edge Verification: Rise Time	7-20
7-21.	Tunnel Diode Pulser Verification.....	7-20
7-22.	Marker Generator Verification	7-20
7-23.	Pulse Generator Verification: Period.....	7-21
7-24.	Pulse Generator Verification: Pulse Width	7-21
7-25.	Input Impedance Verification: Resistance.....	7-21
7-26.	Input Impedance Verification: Capacitance	7-21
7-27.	Current Verification.....	7-22

7-1. Introduction

This chapter explains how to perform the routine maintenance to keep a normally operating 5820A Calibrator in service. These tasks include:

- Replacing the fuse
- Cleaning the air filter
- Cleaning the external surfaces

Refer to the Service manual for intensive maintenance tasks such as calibration or repair, and all procedures that require opening the cover of the instrument. The Service Manual also contains complete verification procedures for checking that traceability to national standards maintained by the normal calibration procedure.

7-2. Replacing the Line Fuse

The line power fuse is accessible on the rear panel. The fuse rating label above the ac power input module shows the correct replacement fuse for each line voltage setting. Table 7-1 lists the fuse part numbers for each line voltage setting.

To check or replace the fuse, refer to Figure 7-1 and proceed as follows:

1. **Disconnect line power.**
2. The line power fuse and line voltage switch are located in a compartment on the right end of the ac input module. To open the compartment and remove the fuse, insert the blade of a standard screwdriver to the left of the tab located at the left side of the compartment cover.
3. Pry the tab out of the slot and the compartment cover will pop part way out.
4. Remove the compartment cover with your fingers.
5. The fuse comes out with the compartment cover and can be easily replaced.
6. To reinstall the fuse, push the compartment cover back into the compartment until the tab locks with the ac input module.

Table 7-1. Replacement Fuses

Part Number	Fuse Description	Line Voltage Setting
△109181	2A/250V SB (Time Delay)	100 V or 120 V
△109272	1A/250V SB (Time Delay)	200 V or 240 V

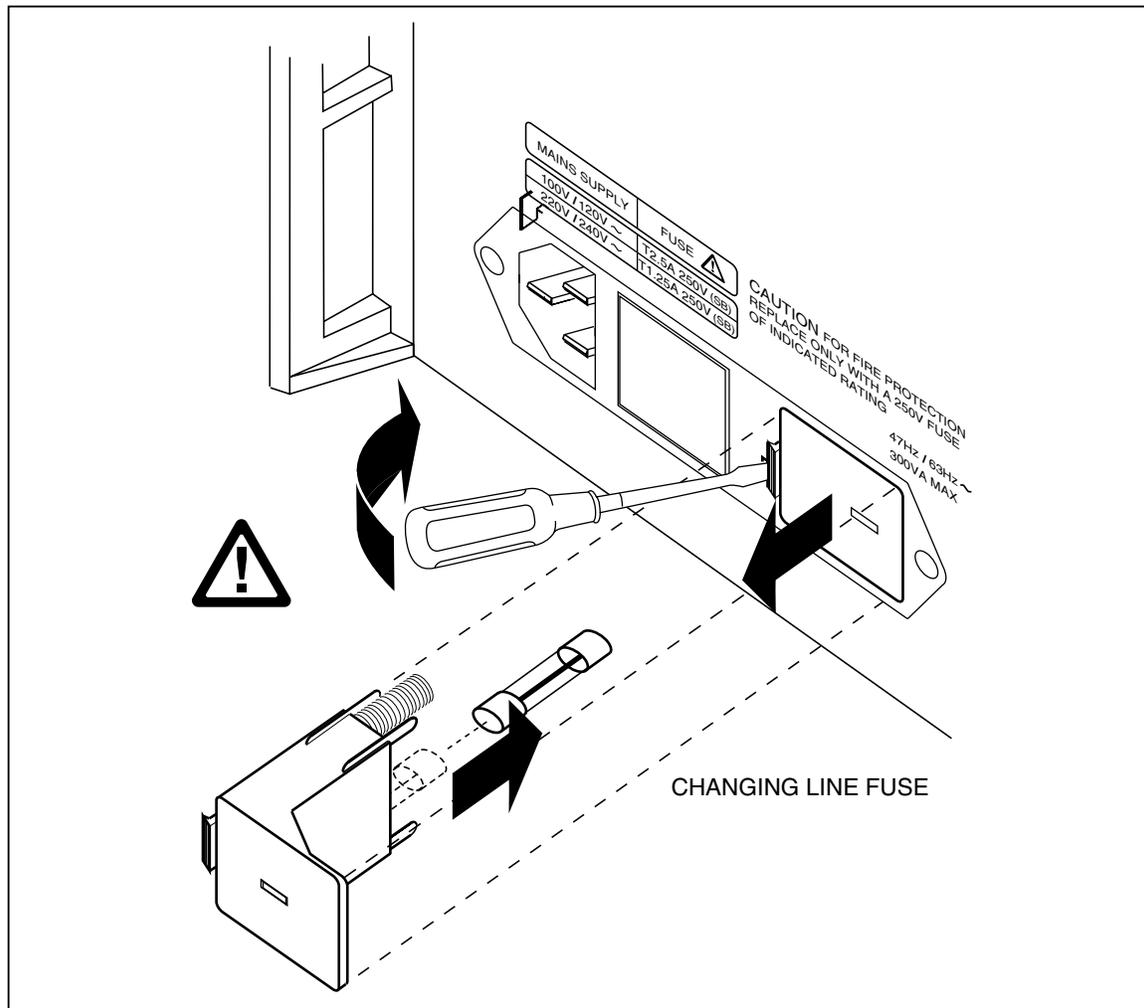

aag067f.eps

Figure 7-1. Accessing the Fuse

7-3. Cleaning the Air Filter

⚠️⚠️ Warning

To avoid risk of injury, never operate or power the 5820A calibrator without the fan filter in place.

⚠️ Caution

To avoid possible damage caused by overheating, keep the area around the fan unrestricted. If the air intake becomes restricted, the intake air will be too warm, or the filter will become clogged.

The air filter must be removed and cleaned every 30 days or more frequently if the calibrator is operated in a dusty environment. The air filter is accessible from the rear panel of the calibrator.

To clean the air filter, refer to Figure 7-2 and proceed as follows:

1. **Disconnect line power.**
2. Remove the filter element.
 - a. Grasp the top and bottom of the air filter frame.
 - b. Squeeze the edges of the frame towards each other to disengage the filter tabs from the slots in the calibrator.
 - c. Pull the filter frame straight out from the calibrator.
3. Clean the filter element.
 - a. Wash the filter element in soapy water.
 - b. Rinse the filter element thoroughly.
 - c. Shake out the excess water, then allow the filter element to dry thoroughly before reinstalling it.
4. Reinstall the filter element by performing the filter removal steps in reverse order.

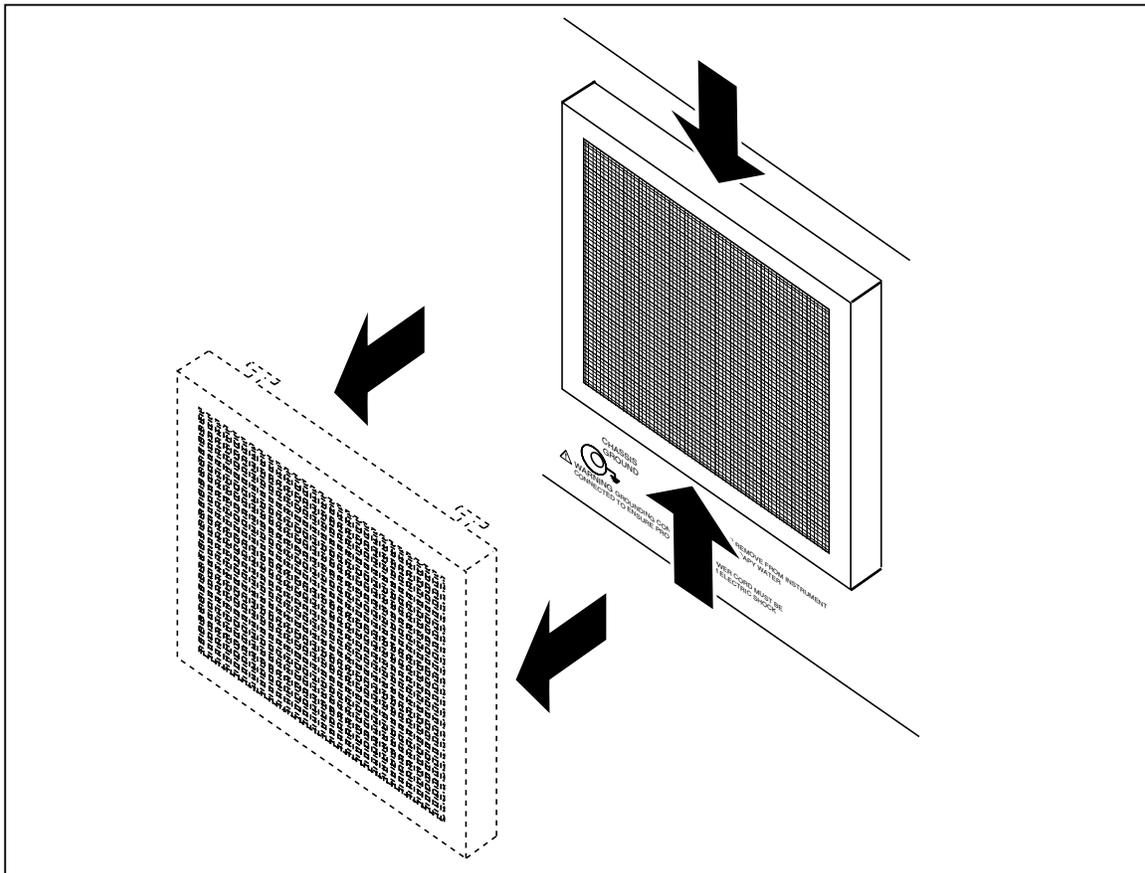

Figure 7-2. Accessing the Air Filter

oq062f.eps

7-4. General Cleaning

For general cleaning, wipe the case, front panel keys, and lens using a soft cloth slightly dampened with water or a non-abrasive mild cleaning solution that does not harm plastics.

⚠ Caution

To prevent damage, do not use aromatic hydrocarbons or chlorinated solvents for cleaning. They can damage the plastic materials used in the calibrator.

7-5. Verification Tables

The verification test points are provided here as a guide when verification to one-year specifications is desired. Verification procedures are located in the 5820A Service Manual.

7-6. DC Voltage Output Verification

Table 7-2. DC Voltage Output Verification

(into 1 M Ω impedance unless noted)			
Nominal Value (V dc)	Measured Value (V dc)	Deviation (V dc)	1-Year Spec.
0			25 μ V
0.00125			25.3 μ V
-0.00125			25.3 μ V
0.00249			25.6 μ V
-0.00249			25.6 μ V
0.0025			25.6 μ V
-0.0025			25.6 μ V
0.00625			26.5 μ V
-0.00625			26.5 μ V
0.0099			27.5 μ V
-0.0099			27.5 μ V
0.01			27.5 μ V
-0.01			27.5 μ V
0.0175			29.4 μ V
-0.0175			29.4 μ V
0.0249			31.2 μ V
-0.0249			31.2 μ V
0.025			31.2 μ V
-0.025			31.2 μ V
0.0675			41.8 μ V
-0.0675			41.8 μ V
0.1099			52.5 μ V
-0.1099			52.5 μ V
0.11			52.5 μ V
-0.11			52.5 μ V
0.305			101.50 μ V
-0.305			101.50 μ V
0.499			150 μ V
-0.499			150 μ V

Table 7-2. DC Voltage Output Verification (cont.)

Nominal Value (V dc)	Measured Value (V dc)	Deviation (V dc)	1-Year Spec.
0.5			150 μ V
-0.5			150 μ V
1.35			362.5 μ V
-1.35			362.5 μ V
2.19			572 μ V
-2.19			572 μ V
2.2			572 μ V
-2.2			572 μ V
6.6			1.67 mV
-6.6			1.67 mV
10.99			2.77 mV
-10.99			2.77 mV
11			2.77 mV
-11			2.77 mV
70.5			17.65 mV
-70.5			17.65 mV
130			32.5 mV
-130			32.5 mV
6.599 (50 Ω)			16.5 mV

7-7. AC Voltage Amplitude Verification

Table 7-3. AC Voltage Amplitude Verification

(into 1 M Ω impedance unless noted)				
Nominal Value (V p-p)	Frequency (Hz)	Measured Value (V p-p)	Deviation (V p-p)	1-year Spec. (V p-p)
0.001	1000			5.5 μ V
-0.001	1000			5.5 μ V
0.025	1000			17.5 μ V
-0.025	1000			17.5 μ V
0.11	1000			60 μ V
-0.11	1000			60 μ V
0.5	1000			255 μ V
-0.5	1000			255 μ V
2.2	1000			1.1 mV
-2.2	1000			1.1 mV
11	1000			5.5 mV
-11	1000			5.5 mV
130	1000			6.5 mV
-130	1000			6.5 mV
6.599 (50 Ω)	1000			16.5 mV

7-8. AC Voltage Frequency Verification

Table 7-4. AC Voltage Frequency Verification

(1 M Ω output impedance unless noted)				
Nominal Value (V p-p)	Frequency (Hz)	Measured Value (Hz)	Deviation (Hz)	1-year Spec. (Hz)
2.1	10			3.3E-6
2.1	100			33E-6
2.1	1000			330E-6
2.1	10000			3.3E-3

7-9. DC Voltage Measurement Verification

Table 7-5. DC Voltage Measurement Verification

Nominal Value (V dc)	Measured Value	Deviation	1-year Spec. (V p-p)
0 V			0.001
1 V			0.0015
2.5 V			0.00225
5 V			0.0035
6.5 V			0.02625
9.9 V			0.03475
-1 V			0.0015
-2.5 V			0.00225
-5 V			0.0035
-6.5 V			0.02625
-9.9 V			0.03475

7-10. Wave Generator Amplitude Verification: 1 MΩ Output Impedance

Table 7-6. Wave Generator Amplitude Verification (into 1 MΩ impedance)

Wave Shape	Nominal Value (V p-p)	Frequency (Hz)	Measured Value (V p-p)	Deviation (V p-p)	1-Year Spec. (V p-p)
square	0.0018	1000			0.000154
square	0.0119	1000			0.000457
square	0.0219	1000			0.000757
square	0.022	1000			0.00076
square	0.056	1000			0.00178
square	0.0899	1000			0.002797
square	0.09	1000			0.0028
square	0.155	1000			0.00475
square	0.219	1000			0.00667
square	0.22	1000			0.0067
square	0.56	1000			0.0169
square	0.899	1000			0.02707
square	0.9	1000			0.0271
square	3.75	1000			0.1126
square	6.59	1000			0.1978
square	6.6	1000			0.1981
square	30.8	1000			0.9241
square	55	10			1.6501
square	55	100			1.6501
square	55	1000			1.6501
square	55	10000			1.6501
sine	0.0018	1000			0.000154
sine	0.0219	1000			0.000757
sine	0.0899	1000			0.002797
sine	0.219	1000			0.00667
sine	0.899	1000			0.02707
sine	6.59	1000			0.1978
sine	55	1000			1.6501
triangle	0.0018	1000			0.000154
triangle	0.0219	1000			0.000757
triangle	0.0899	1000			0.002797
triangle	0.219	1000			0.00667
triangle	0.899	1000			0.02707
triangle	6.59	1000			0.1978
triangle	55	1000			1.6501

7-11. Wave Generator Amplitude Verification: 50 Ω Output Impedance**Table 7-7. Wave Generator Amplitude Verification (into 50 Ω impedance)**

Wave Shape	Nominal Value (V p-p)	Frequency (Hz)	Measured Value (V p-p)	Deviation (V p-p)	1-Year Spec. (V p-p)
square	0.0018	1000			0.000154
square	0.0064	1000			0.000292
square	0.0109	1000			0.000427
square	0.011	1000			0.00043
square	0.028	1000			0.00094
square	0.0449	1000			0.001447
square	0.045	1000			0.00145
square	0.078	1000			0.00244
square	0.109	1000			0.00337
square	0.11	1000			0.0034
square	0.28	1000			0.0085
square	0.449	1000			0.01357
square	0.45	1000			0.0136
square	0.78	1000			0.0235
square	1.09	1000			0.0328
square	1.1	1000			0.0331
square	1.8	1000			0.0541
square	2.5	10			0.0751
square	2.5	100			0.0751
square	2.5	1000			0.0751
square	2.5	10000			0.0751
sine	0.0018	1000			0.000154
sine	0.0109	1000			0.000427
sine	0.0449	1000			0.001447
sine	0.109	1000			0.00337
sine	0.449	1000			0.01357
sine	1.09	1000			0.0328
sine	2.5	1000			0.0751
triangle	0.0018	1000			0.000154
triangle	0.0109	1000			0.000427
triangle	0.0449	1000			0.001447
triangle	0.109	1000			0.00337
triangle	0.449	1000			0.01357
triangle	1.09	1000			0.0328
triangle	2.5	1000			0.0751

7-12. Wave Generator Frequency Verification: 1 MΩ Output Impedance

Table 7-8. Wave Generator Frequency Verification (into 1 MΩ Impedance)

Nominal Value (V p-p)	Frequency	Measured Value (Hz)	Deviation (Hz)	1-Year Spec. (Hz)
2.1	1			7.5000E-06
2.1	10			3.0000E-05
2.1	100			2.5500E-04
2.1	1000			2.5050E-03
2.1	10000			2.5005E-02
2.1	100000			2.5001E-01

7-13. Leveled Sinewave Verification: Amplitude

Table 7-9. Leveled Sinewave Verification: Amplitude

Nominal Value (V p-p)	Frequency	Measured Value (V p-p)	Deviation (V p-p)	1-Year Spec. (V p-p)
0.005	50 kHz			0.0004
0.0075	50 kHz			0.00045
0.0099	50 kHz			0.000498
0.01	50 kHz			0.0005
0.025	50 kHz			0.0008
0.039	50 kHz			0.00108
0.04	50 kHz			0.0011
0.07	50 kHz			0.0017
0.099	50 kHz			0.00228
0.1	50 kHz			0.0023
0.25	50 kHz			0.0053
0.399	50 kHz			0.00828
0.4	50 kHz			0.0083
0.8	50 kHz			0.0163
1.2	50 kHz			0.0243
1.3	50 kHz			0.0263
3.4	50 kHz			0.0683
5.5	50 kHz			0.1103

7-14. Leveled Sinewave Verification: Frequency

Table 7-10. Leveled Sinewave Verification: Frequency

Nominal Value (V p-p)	Frequency	Measured Value (Hz)	Deviation (Hz)	1-Year Spec. (Hz)
5.5	50 kHz			16.5E-3
5.5	1 MHz			330E-3
5.5	10 MHz			3.3
5.5	100 MHz			33
5.5	600 MHz			198

7-15. Leveled Sinewave Verification: Harmonics

Table 7-11. Leveled Sinewave Verification: Harmonics

Calibrator Mainframe Output Frequency (@ 5.5 V p-p)	Harmonic	HP 8590A Reading (dB)	Tolerance
50 kHz	2		-33 dB
50 kHz	3, 4, 5		-38 dB
100 kHz	2		-33 dB
100 kHz	3, 4, 5		-38 dB
200 kHz	2		-33 dB
200 kHz	3, 4, 5		-38 dB
400 kHz	2		-33 dB
400 kHz	3, 4, 5		-38 dB
800 kHz	2		-33 dB
800 kHz	3, 4, 5		-38 dB
1 MHz	2		-33 dB
1 MHz	3, 4, 5		-38 dB
2 MHz	2		-33 dB
2 MHz	3, 4, 5		-38 dB
4 MHz	2		-33 dB
4 MHz	3, 4, 5		-38 dB
8 MHz	2		-33 dB
8 MHz	3, 4, 5		-38 dB
10 MHz	2		-33 dB
10 MHz	3, 4, 5		-38 dB
20 MHz	2		-33 dB
20 MHz	3, 4, 5		-38 dB
40 MHz	2		-33 dB
40 MHz	3, 4, 5		-38 dB
80 MHz	2		-33 dB
80 MHz	3, 4, 5		-38 dB
100 MHz	2		-33 dB
100 MHz	3, 4, 5		-38 dB
200 MHz	2		-33 dB
200 MHz	3, 4, 5		-38 dB
400 MHz	2		-33 dB
400 MHz	3, 4, 5		-38 dB
600 MHz	2		-33 dB
600 MHz	3, 4, 5		-38 dB

7-16. Leveled Sinewave Verification: Flatness

Table 7-12. Leveled Sinewave Verification: Flatness

Nominal Value (V p-p)	Frequency	Measured Value (V p-p)	Deviation (V p-p)	1-Year Spec. (V p-p)
0.005	50 kHz		na	na
0.005	1 MHz			0.000175
0.005	10 MHz			0.000175
0.005	50 MHz			0.000175
0.005	100 MHz			0.000175
0.005	150 MHz			0.0002
0.005	200 MHz			0.0002
0.005	250 MHz			0.0002
0.005	300 MHz			0.0002
0.005	350 MHz			0.0003
0.005	400 MHz			0.0003
0.005	450 MHz			0.0003
0.005	500 MHz			0.0003
0.005	550 MHz			0.0003
0.005	600 MHz			0.0003
0.0075	50 kHz		na	na
0.0075	1 MHz			0.0002125
0.0075	10 MHz			0.0002125
0.0075	50 MHz			0.0002125
0.0075	100 MHz			0.0002125
0.0075	150 MHz			0.00025
0.0075	200 MHz			0.00025
0.0075	250 MHz			0.00025
0.0075	300 MHz			0.00025
0.0075	350 MHz			0.0004
0.0075	400 MHz			0.0004
0.0075	450 MHz			0.0004
0.0075	500 MHz			0.0004
0.0075	550 MHz			0.0004
0.0075	600 MHz			0.0004
0.0099	50 kHz		na	na
0.0099	1 MHz			0.0002485
0.0099	10 MHz			0.0002485
0.0099	50 MHz			0.0002485
0.0099	100 MHz			0.0002485
0.0099	150 MHz			0.000298
0.0099	200 MHz			0.000298
0.0099	250 MHz			0.000298
0.0099	300 MHz			0.000298
0.0099	350 MHz			0.000496
0.0099	400 MHz			0.000496
0.0099	450 MHz			0.000496
0.0099	500 MHz			0.000496
0.0099	550 MHz			0.000496
0.0099	600 MHz			0.000496

Table 7-12. Levelled Sinewave Verification: Flatness (cont.)

Nominal Value (V p-p)	Frequency	Measured Value (V p-p)	Deviation (V p-p)	1-Year Spec. (V p-p)
0.01	50 kHz		na	na
0.01	1 MHz			0.00025
0.01	10 MHz			0.00025
0.01	50 MHz			0.00025
0.01	100 MHz			0.00025
0.01	150 MHz			0.0003
0.01	200 MHz			0.0003
0.01	250 MHz			0.0003
0.01	300 MHz			0.0003
0.01	350 MHz			0.0005
0.01	400 MHz			0.0005
0.01	450 MHz			0.0005
0.01	500 MHz			0.0005
0.01	550 MHz			0.0005
0.01	600 MHz			0.0005
0.025	50 kHz		na	na
0.025	1 MHz			0.000475
0.025	10 MHz			0.000475
0.025	50 MHz			0.000475
0.025	100 MHz			0.000475
0.025	150 MHz			0.0006
0.025	200 MHz			0.0006
0.025	250 MHz			0.0006
0.025	300 MHz			0.0006
0.025	350 MHz			0.0011
0.025	400 MHz			0.0011
0.025	450 MHz			0.0011
0.025	500 MHz			0.0011
0.025	550 MHz			0.0011
0.025	600 MHz			0.0011
0.039	50 kHz		na	na
0.039	1 MHz			0.000685
0.039	10 MHz			0.000685
0.039	50 MHz			0.000685
0.039	100 MHz			0.000685
0.039	150 MHz			0.00088
0.039	200 MHz			0.00088
0.039	250 MHz			0.00088
0.039	300 MHz			0.00088
0.039	350 MHz			0.00166
0.039	400 MHz			0.00166
0.039	450 MHz			0.00166
0.039	500 MHz			0.00166
0.039	550 MHz			0.00166
0.039	600 MHz			0.00166
0.04	50 kHz		na	na
0.04	1 MHz			0.0007

Table 7-12. Leveled Sinewave Verification: Flatness (cont.)

Nominal Value (V p-p)	Frequency	Measured Value (V p-p)	Deviation (V p-p)	1-Year Spec. (V p-p)
0.04	10 MHz			0.0007
0.04	50 MHz			0.0007
0.04	100 MHz			0.0007
0.04	150 MHz			0.0009
0.04	200 MHz			0.0009
0.04	250 MHz			0.0009
0.04	300 MHz			0.0009
0.04	350 MHz			0.0017
0.04	400 MHz			0.0017
0.04	450 MHz			0.0017
0.04	500 MHz			0.0017
0.04	550 MHz			0.0017
0.04	600 MHz			0.0017
0.07	50 kHz		na	na
0.07	1 MHz			0.00115
0.07	10 MHz			0.00115
0.07	50 MHz			0.00115
0.07	100 MHz			0.00115
0.07	150 MHz			0.0015
0.07	200 MHz			0.0015
0.07	250 MHz			0.0015
0.07	300 MHz			0.0015
0.07	350 MHz			0.0029
0.07	400 MHz			0.0029
0.07	450 MHz			0.0029
0.07	500 MHz			0.0029
0.07	550 MHz			0.0029
0.07	600 MHz			0.0029
0.099	50 kHz		na	na
0.099	1 MHz			0.001585
0.099	10 MHz			0.001585
0.099	50 MHz			0.001585
0.099	100 MHz			0.001585
0.099	150 MHz			0.00208
0.099	200 MHz			0.00208
0.099	250 MHz			0.00208
0.099	300 MHz			0.00208
0.099	350 MHz			0.00406
0.099	400 MHz			0.00406
0.099	450 MHz			0.00406
0.099	500 MHz			0.00406
0.099	550 MHz			0.00406
0.099	600 MHz			0.00406
0.1	50 kHz		na	na
0.1	1 MHz			0.0016
0.1	10 MHz			0.0016
0.1	50 MHz			0.0016

Table 7-12. Leveled Sinewave Verification: Flatness (cont.)

Nominal Value (V p-p)	Frequency	Measured Value (V p-p)	Deviation (V p-p)	1-Year Spec. (V p-p)
0.1	100 MHz			0.0016
0.1	150 MHz			0.0021
0.1	200 MHz			0.0021
0.1	250 MHz			0.0021
0.1	300 MHz			0.0021
0.1	350 MHz			0.0041
0.1	400 MHz			0.0041
0.1	450 MHz			0.0041
0.1	500 MHz			0.0041
0.1	550 MHz			0.0041
0.1	600 MHz			0.0041
0.25	50 kHz		na	na
0.25	1 MHz			0.00385
0.25	10 MHz			0.00385
0.25	50 MHz			0.00385
0.25	100 MHz			0.00385
0.25	150 MHz			0.0051
0.25	200 MHz			0.0051
0.25	250 MHz			0.0051
0.25	300 MHz			0.0051
0.25	350 MHz			0.0101
0.25	400 MHz			0.0101
0.25	450 MHz			0.0101
0.25	500 MHz			0.0101
0.25	550 MHz			0.0101
0.25	600 MHz			0.0101
0.399	50 kHz		na	na
0.399	1 MHz			0.006085
0.399	10 MHz			0.006085
0.399	50 MHz			0.006085
0.399	100 MHz			0.006085
0.399	150 MHz			0.00808
0.399	200 MHz			0.00808
0.399	250 MHz			0.00808
0.399	300 MHz			0.00808
0.399	350 MHz			0.01606
0.399	400 MHz			0.01606
0.399	450 MHz			0.01606
0.399	500 MHz			0.01606
0.399	550 MHz			0.01606
0.399	600 MHz			0.01606
0.4	50 kHz		na	na
0.4	1 MHz			0.0061
0.4	10 MHz			0.0061
0.4	50 MHz			0.0061
0.4	100 MHz			0.0061
0.4	150 MHz			0.0081

Table 7-12. Leveled Sinewave Verification: Flatness (cont.)

Nominal Value (V p-p)	Frequency	Measured Value (V p-p)	Deviation (V p-p)	1-Year Spec. (V p-p)
0.4	200 MHz			0.0081
0.4	250 MHz			0.0081
0.4	300 MHz			0.0081
0.4	350 MHz			0.0161
0.4	400 MHz			0.0161
0.4	450 MHz			0.0161
0.4	500 MHz			0.0161
0.4	550 MHz			0.0161
0.4	600 MHz			0.0161
0.8	50 kHz		na	na
0.8	1 MHz			0.0121
0.8	10 MHz			0.0121
0.8	50 MHz			0.0121
0.8	100 MHz			0.0121
0.8	150 MHz			0.0161
0.8	200 MHz			0.0161
0.8	250 MHz			0.0161
0.8	300 MHz			0.0161
0.8	350 MHz			0.0321
0.8	400 MHz			0.0321
0.8	450 MHz			0.0321
0.8	500 MHz			0.0321
0.8	550 MHz			0.0321
0.8	600 MHz			0.0321
1.2	50 kHz		na	na
1.2	1 MHz			0.0181
1.2	10 MHz			0.0181
1.2	50 MHz			0.0181
1.2	100 MHz			0.0181
1.2	150 MHz			0.0241
1.2	200 MHz			0.0241
1.2	250 MHz			0.0241
1.2	300 MHz			0.0241
1.2	350 MHz			0.0481
1.2	400 MHz			0.0481
1.2	450 MHz			0.0481
1.2	500 MHz			0.0481
1.2	550 MHz			0.0481
1.2	600 MHz			0.0481
1.3	50 kHz		na	na
1.3	1 MHz			0.0196
1.3	10 MHz			0.0196
1.3	50 MHz			0.0196
1.3	100 MHz			0.0196
1.3	150 MHz			0.0261
1.3	200 MHz			0.0261
1.3	250 MHz			0.0261

Table 7-12. Levelled Sinewave Verification: Flatness (cont.)

Nominal Value (V p-p)	Frequency	Measured Value (V p-p)	Deviation (V p-p)	1-Year Spec. (V p-p)
1.3	300 MHz			0.0261
1.3	350 MHz			0.0521
1.3	400 MHz			0.0521
1.3	450 MHz			0.0521
1.3	500 MHz			0.0521
1.3	550 MHz			0.0521
1.3	600 MHz			0.0521
3.4	50 kHz		na	na
3.4	1 MHz			0.0511
3.4	10 MHz			0.0511
3.4	50 MHz			0.0511
3.4	100 MHz			0.0511
3.4	150 MHz			0.0681
3.4	200 MHz			0.0681
3.4	250 MHz			0.0681
3.4	300 MHz			0.0681
3.4	350 MHz			0.1361
3.4	400 MHz			0.1361
3.4	450 MHz			0.1361
3.4	500 MHz			0.1361
3.4	550 MHz			0.1361
3.4	600 MHz			0.1361
5.5	50 kHz		na	na
5.5	1 MHz			0.0826
5.5	10 MHz			0.0826
5.5	50 MHz			0.0826
5.5	100 MHz			0.0826
5.5	150 MHz			0.1101
5.5	200 MHz			0.1101
5.5	250 MHz			0.1101
5.5	300 MHz			0.1101
5.5	350 MHz			0.2201
5.5	400 MHz			0.2201
5.5	450 MHz			0.2201
5.5	500 MHz			0.2201
5.5	550 MHz			0.2201
5.5	600 MHz			0.2201

7-17. Edge Verification: Amplitude

Table 7-13. Edge Verification: Amplitude

Nominal Value (V p-p)	Frequency (Hz)	Measured Value (V p-p)	Deviation (V p-p)	1-Year Spec. (V p-p)
0.005	1 kHz			0.0003 (typical)
0.005	10 kHz			0.0003 (typical)
0.005	100 kHz			0.0003 (typical)
0.01	100 kHz			0.0004 (typical)
0.025	100 kHz			0.0007 (typical)
0.05	100 kHz			0.0012 (typical)
0.1	100 kHz			0.0022 (typical)
0.25	100 kHz			0.0052
0.5	100 kHz			0.0102
1	100 kHz			0.0202
2.5	100 kHz			0.0502
2.5	10 kHz			0.0502
2.5	1 kHz			0.0502

7-18. Edge Verification: Frequency

Table 7-14. Edge Verification: Frequency

Nominal Value (V p-p)	Frequency	Measured Value (Hz)	Deviation (Hz)	1-Year Spec. (Hz)
2.5	1 kHz			330E-6
2.5	10 kHz			3.3E-3
2.5	100 kHz			33E-3
2.5	1 MHz			330E-3
2.5	10 MHz			3.3E-0

7-19. Edge Verification: Duty Cycle

Table 7-15. Edge Verification: Duty Cycle

Nominal Value (V p-p)	Frequency	Measured Value (%)	Deviation (from 50 %)	1-Year Spec. (%)
2.5	1 MHz			5 (typical)

7-20. Edge Verification: Rise Time

Table 7-16. Edge Verification: Rise Time

Nominal Value (V p-p)	Frequency	Measured Value (s)	Deviation (ns)	1-Year Spec. (ns)
0.25	1 kHz			0.3 ns
0.25	100 kHz			0.3 ns
0.25	2 MHz			0.3 ns
0.5	1 kHz			0.3 ns
0.5	100 kHz			0.3 ns
0.5	2 MHz			0.3 ns
1	1 kHz			0.3 ns
1	100 kHz			0.3 ns
1	2 MHz			0.3 ns
2.5	1 kHz			0.3 ns
2.5	100 kHz			0.3 ns
2.5	2 MHz			0.3 ns
All	10 MHz			0.35 ns

7-21. Tunnel Diode Pulser Verification

Table 7-17. Tunnel Diode Pulser Verification

Nominal Value (V p-p)	Frequency (Hz)	Measured Value (V p-p)	Deviation (V p-p)	1-Year Spec. (V p-p)
11	100			0.2202
11	10000			0.2202
55	100			1.1002
55	10000			1.1002
100	100			2.0002
100	10000			2.0002

7-22. Marker Generator Verification

Table 7-18. Marker Generator Verification

Period (s)	Measured Value (s)	Deviation (s)	1-Year Spec. (s)
5			1.4×10^{-4}
2			2.5×10^{-5}
0.05			1.4×10^{-7}
0.02			6.6E-9
0.01			3.3E-9
1.0×10^{-7}			33E-15
5.0×10^{-8}			16.5-15
50×10^{-9}			16.5E-9
2.0×10^{-8}			6.6E-15
1.0×10^{-8}			3.3E-15
5.0×10^{-9}			1.65E-15
2.0×10^{-9}			660E-18

7-23. Pulse Generator Verification: Period

Table 7-19. Pulse Generator Verification: Period

Nominal Value (V p-p)	Pulse Width (s)	Period (s)	Measured Value (s)	Deviation (s)	1-Year Spec. (s)
1.5	4.0×10^{-8}	2.0×10^{-6}			660E-15
1.5	5.0×10^{-7}	0.01			3.3E-9
1.5	5.0×10^{-7}	0.02			6.6E-9

7-24. Pulse Generator Verification: Pulse Width

Table 7-20. Pulse Generator Verification: Pulse Width

Nominal Value (V p-p)	Pulse Width (s)	Period (s)	Measured Value (s)	Deviation (s)	1-Year Spec. (s)
0.15	4.0×10^{-9}	2.0×10^{-6}			400E-12
0.15	4.0×10^{-8}	2.0×10^{-6}			2.2E-9
0.15	4.1×10^{-8}	2.0×10^{-6}			2.25E-9
0.15	5.0×10^{-7}	2.0×10^{-6}			25.2E-9
1.5	4.0×10^{-9}	2.0×10^{-3}			400E-12
1.5	4.0×10^{-8}	2.0×10^{-3}			2.2E-9
1.5	4.1×10^{-8}	2.0×10^{-3}			2.25E-9
1.5	5.0×10^{-7}	2.0×10^{-3}			25.2E-9

7-25. Input Impedance Verification: Resistance

Table 7-21. Input Impedance Verification: Resistance

Nominal Value (Ω)	Measured Value (Ω)	Deviation (Ω)	1-Year Spec. (Ω)
40			0.04
50			0.05
60			0.06
600000			600
1000000			1000
1500000			1500

7-26. Input Impedance Verification: Capacitance

Table 7-22. Input Impedance Verification: Capacitance

Nominal Value (pF)	Measured Value (pF)	Deviation (pF)	1-Year Spec. (pF)
5 pF			0.75 pF
29 pF			1.95 pF
49 pF			2.95 pF

7-27. Current Verification**Table 7-23. DC Current Verification**

Calibrator Mainframe Output	Measured Value	Deviation	Tolerance (mA DC)
0.100 mA			0.000750
-0.100 mA			0.000750
0.550 mA			0.001875
-0.550 mA			0.001875
1.099 mA			0.003248
-1.099 mA			0.003248
1.100 mA			0.003250
-1.100 mA			0.003250
5.50 mA			0.014250
-5.50 mA			0.014250
10.99 mA			0.027975
-10.99 mA			0.027975
11.00 mA			0.028000
-11.00 mA			0.028000
50.00 mA			0.125500
-50.00 mA			0.125500
100.0 mA			0.250500
-100.0 mA			0.250500

Table 7-24. AC Current Verification

Nominal Output Current @ Resistance Value	Frequency (Hz)	Measured Value	Deviation	Tolerance (\pm mA)
0.10 mA @ 1k Ω	45	Ω		0.000750
-0.10 mA @ 1k Ω	45			0.000750
0.10 mA @ 1k Ω	500			0.000750
-0.10 mA @ 1k Ω	500			0.000750
0.10 mA @ 1k Ω	1000			0.000750
-0.10 mA @ 1k Ω	1000			0.000750
1.099 mA @ 100 Ω	45			0.003248
-1.099 mA @ 100 Ω	45			0.003248
1.099 mA @ 100 Ω	500			0.003248
-1.099 mA @ 100 Ω	500			0.003248
1.099 mA @ 100 Ω	1000			0.003248
-1.099 mA @ 100 Ω	1000			0.003248
1.10 mA @ 100 Ω	45			0.003250

Table 7-24. AC Current Verification (cont)

Nominal Output Current @ Resistance Value	Frequency (Hz)	Measured Value	Deviation	Tolerance (\pm mA)
-1.10 mA@ 100 Ω	45			0.003250
1.10 mA@ 100 Ω	500			0.003250
-1.10 mA@ 100 Ω	500			0.003250
1.10 mA@ 100 Ω	1000			0.003250
-1.10 mA@ 100 Ω	1000			0.003250
10.99 mA@ 10 Ω	45			0.027975
-10.99 mA@ 10 Ω	45			0.027975
10.99 mA@ 10 Ω	500			0.027975
-10.99 mA@ 10 Ω	500			0.027975
10.99 mA@ 10 Ω	1000			0.027975
-10.99 mA@ 10 Ω	1000			0.027975
11.00 mA@ 10 Ω	45			0.028000
-11.00 mA@ 10 Ω	45			0.028000
11.00 mA@ 10 Ω	500			0.028000
-11.00 mA@ 10 Ω	500			0.028000
11.00 mA@ 10 Ω	1000			0.028000
-11.00 mA@ 10 Ω	1000			0.028000
50.00 mA@ 1 Ω	45			0.125500
-50.00 mA@ 1 Ω	45			0.125500
50.00 mA@ 1 Ω	500			0.125500
-50.00 mA@ 1 Ω	500			0.125500
50.00 mA@ 1 Ω	1000			0.125500
-50.00 mA@ 1 Ω	1000			0.125500
100 mA@ 1 Ω	45			0.250500
-100 mA@ 1 Ω	45			0.250500
100 mA@ 1 Ω	500			0.250500
-100 mA@ 1 Ω	500			0.250500
100 mA@ 1 Ω	1000			0.250500
-100 mA@ 1 Ω	1000			0.250500

Chapter 8

Options

	Title	Page
8-1.	Introduction.....	8-3
8-2.	5820A-5 Option	8-3
8-3.	GHz Option.....	8-3
8-4.	Using the GHz Option Functions	8-3
8-5.	Fast Edge Specifications.....	8-4
8-6.	Leveled Sine Wave (> 600 MHz) Specifications	8-5
8-7.	Time Marker Specifications	8-6
8-8.	GHz Option Verification Tables	8-7
8-9.	Extended Leveled Sinewave Verification: Flatness	8-7
8-10.	Leveled Sinewave Verification: Harmonics.....	8-15

8-1. Introduction

This chapter documents options that are available for the 5820A Oscilloscope Calibrators.

8-2. 5820A-5 Option

The 5820A-5 option allows you to operate up to five oscilloscope channels without changing cables. This allows you to perform fast, automated calibrations with documented procedures and results while freeing the operator to complete other work. You can find this option discussed throughout the manual where appropriate.

8-3. GHz Option

Inclusion of the GHz option modifies several of the Calibrator's specifications. The following specification tables supersede those with the similar titles in Chapter 1.

- Fast Edge Specifications
- Leveled Sine Wave Specifications (> 600 MHz)
- Time Marker Specifications

8-4. Using the GHz Option Functions

The GHz option extends the ranges of the Leveled Sine Wave and Time Marker functions as follows:

- Leveled Sine Wave frequency range is increased from 600 MHz to 2.1 GHz.
- Time Marker function smallest period is decreased from 2 ns to 500 ps.

Access to these extended ranges is automatic if the GHz Option is installed. Use the operating methods described in Chapter 4.

8-5. Fast Edge Specifications

The inclusion of the GHz Option extends the normal Edge specifications, creating a Fast Edge feature.

Table 8-1. Fast Edge Specifications

Edge Characteristics into 50 Ω		1-Year Absolute Uncertainty, tcal ± 5 $^{\circ}\text{C}$
Amplitude		
Range (p-p)	250 mV	
Adjustment Range	none	
Other Edge Characteristics		
Frequency Range	1 kHz to 100 kHz	\pm (0.33 ppm of setting)
Rise Time	≤ 150 ps	+0/- 50ps
[1] All readings are referenced to a Tek11801 with an SD26 module or a Tek820 oscilloscope with a 8-GHz bandwidth option.		

8-6. Leveled Sine Wave (> 600 MHz) Specifications*Note*

To ensure applied frequencies above 600 MHz meet factory specifications, the user **MUST** use the special 10 MHz reference that is installed in the high frequency section of the 5820A. To use this reference frequency, follow these instructions:

1. Key in the frequency value (e.g. 601 MHz).
2. When the frequency is above 600 MHz, the display on the right side of the 5820A will read "SET TO R 10MHz".
3. Push the SET TO R 10MHz blue softkey.
4. Make sure that "REF 10 Mhz" (NOT 10 MHz) shows on the left side display.

Table 8-2. Leveled Sine Wave Specifications (> 600 MHz)

Leveled Sine Wave Characteristics into 50 Ω	Frequency Range			
	10 MHz (reference)	600 MHz to 1.1 GHz	1.1 GHz to 1.6 GHz	1.6 GHz to 2.1 GHz
Amplitude Characteristics				
Range (p-p)	5 mV to 3.5 V			
Resolution	< 100 mV: 3 digits ≥ 100 mV: 4 digits			
Adjustment Range	continuously adjustable			
1-Year Absolute Uncertainty, tcal \pm 5 $^{\circ}$ C	\pm (2% of output + 300 μ V)	\pm (7% of output + 300 μ V)	\pm (7% of output + 300 μ V)	\pm (8% of output + 300 μ V)
Flatness (relative to 10 MHz) [1]	not applicable	\pm (5% of output + 100 μ V)	\pm (5% of output + 100 μ V)	\pm (6% of output + 100 μ V)
Short-term Amplitude Stability	\leq 1% [2]			
Frequency Characteristics				
Resolution	100 kHz			
1-Year Absolute Uncertainty, tcal \pm 5 $^{\circ}$ C	\pm 0.33 ppm			
Distortion Characteristics [3]				
2nd Harmonic	\leq -33 dBc			
3rd and Higher Harmonics	\leq -38 dBc			
[1] As measured near Oscilloscope bandwidth frequency. [2] Within one hour after reference amplitude setting, provided temperature varies no more than \pm 5 $^{\circ}$ C. [3] Harmonics above 2.1 GHz are typical				

8-7. Time Marker Specifications

Table 8-3. Time Marker Specifications

Time Marker into 50 Ω	5 s to 50 ms	20 ms to 100 ns (max)	50 ns to 20 ns	10 ns	5 ns to 2 ns	2 ns to 500 ps
Wave Shape	spike or square	spike, square, or 20%-pulse	spike or square	square or sine	sine	sine
Typical Output Level	> 1V pk	> 1V pk [1]	> 1V pk [1]	> 1V pk [1]	> 1V p-p	> 1V p-p
Typical Jitter (p-p)	<10 ppm	< 1 ppm	< 1 ppm	<1 ppm	<1 ppm	<1 ppm
Sequence	5-2-1 from 5 s to 2 ns (e.g., 500 ms, 200 ms, 100 ms)					
Period Resolution	4 digits					
1-Year Absolute Uncertainty, tcal ± 5 °C [3]	± (2.5 ppm + 5μ Hz) [2]	± 0.33 ppm	± 0.33 ppm	±0.33 ppm	±0.33 ppm	± 0.33 ppm
<p>[1] Typical rise time of square wave and 20%-pulse (20% duty cycle positive pulse) is < 1.5 ns.</p> <p>[2] With 10 MHz external reference selected, the uncertainty becomes that of the external clock plus 5 μHz (as an example of determining the uncertainty, if the internal clock was used for a 5 s Time Marker period, the ppm uncertainty would be = 2.5 ppm + [5 μ Hz * 5s * 1E⁶] = 27.5 ppm ~ 0.1375 ms).</p> <p>[3] Time marker uncertainty is +/-50 ppm when measured off of cardinal points.</p>						

8-8. GHz Option Verification Tables

The GHz option modifies some of the range capabilities of the 5820A Calibrator. The following verification tables reflect these range modifications.

8-9. Extended Leveled Sinewave Verification: Flatness**Table 8-4. Leveled Sinewave Verification: Flatness**

Calibrator Mainframe Freq. (MHz)	Measured Power Out (w)	10 MHz Power Out (w)	Deviation (w)	% Deviation	Calibrator Mainframe Flatness Spec. (%)
3.5 Vpp					
625,000,000					± 5.0
725,000,000					± 5.0
900,000,000					± 5.0
1,125,000,000					± 5.0
1,250,000,000					± 5.0
1,325,000,000					± 5.0
1,375,000,000					± 5.0
1,425,000,000					± 5.0
1,475,000,000					± 5.0
1,525,000,000					± 5.0
1,575,000,000					± 5.0
1,650,000,000					± 6.0
1,750,000,000					± 6.0
1,850,000,000					± 6.0
1,925,000,000					± 6.0
1,975,000,000					± 6.0
2,025,000,000					± 6.0
2,075,000,000					± 6.0
1.3 Vpp					
625,000,000					± 5.0
725,000,000					± 5.0
900,000,000					± 5.0
1,125,000,000					± 5.0
1,250,000,000					± 5.0
1,325,000,000					± 5.0
1,375,000,000					± 5.0
1,425,000,000					± 5.0
1,475,000,000					± 5.0

Table 8-4. Levelled Sinewave Verification: Flatness (cont.)

Calibrator Mainframe Freq. (MHz)	Measured Power Out (w)	10 MHz Power Out (w)	Deviation (w)	% Deviation	Calibrator Mainframe Flatness Spec. (%)
1,525,000,000					± 5.0
1,575,000,000					± 5.0
1,650,000,000					± 6.0
1,750,000,000					± 6.0
1,850,000,000					± 6.0
1,925,000,000					± 6.0
1,975,000,000					± 6.0
2,025,000,000					± 6.0
2,075,000,000					± 6.0
1.2 Vpp					
625,000,000					± 5.0
725,000,000					± 5.0
900,000,000					± 5.0
1,125,000,000					± 5.0
1,250,000,000					± 5.0
1,325,000,000					± 5.0
1,375,000,000					± 5.0
1,425,000,000					± 5.0
1,475,000,000					± 5.0
1,525,000,000					± 5.0
1,575,000,000					± 5.0
1,650,000,000					± 6.0
1,750,000,000					± 6.0
1,850,000,000					± 6.0
1,925,000,000					± 6.0
1,975,000,000					± 6.0
2,025,000,000					± 6.0
2,075,000,000					± 6.0
0.800 Vpp					
625,000,000					± 5.0
725,000,000					± 5.0
900,000,000					± 5.0

Table 8-4. Leveled Sinewave Verification: Flatness (cont.)

Calibrator Mainframe Freq. (MHz)	Measured Power Out (w)	10 MHz Power Out (w)	Deviation (w)	% Deviation	Calibrator Mainframe Flatness Spec. (%)
1,125,000,000					± 5.0
1,250,000,000					± 5.0
1,325,000,000					± 5.0
1,375,000,000					± 5.0
1,425,000,000					± 5.0
1,475,000,000					± 5.0
1,525,000,000					± 5.0
1,575,000,000					± 5.0
1,650,000,000					± 6.0
1,750,000,000					± 6.0
1,850,000,000					± 6.0
1,925,000,000					± 6.0
1,975,000,000					± 6.0
2,025,000,000					± 6.0
2,075,000,000					± 6.0
0.400 Vpp					
625,000,000					± 5.0
725,000,000					± 5.0
900,000,000					± 5.0
1,125,000,000					± 5.0
1,250,000,000					± 5.0
1,325,000,000					± 5.0
1,375,000,000					± 5.0
1,425,000,000					± 5.0
1,475,000,000					± 5.0
1,525,000,000					± 5.0
1,575,000,000					± 5.0
1,650,000,000					± 6.0
1,750,000,000					± 6.0
1,850,000,000					± 6.0
1,925,000,000					± 6.0
1,975,000,000					± 6.0

Table 8-4. Levelled Sinewave Verification: Flatness (cont.)

Calibrator Mainframe Freq. (MHz)	Measured Power Out (w)	10 MHz Power Out (w)	Deviation (w)	% Deviation	Calibrator Mainframe Flatness Spec. (%)
2,025,000,000					± 6.0
2,075,000,000					± 6.0
0.250 Vpp					
625,000,000					± 5.0
725,000,000					± 5.0
900,000,000					± 5.0
1,125,000,000					± 5.0
1,250,000,000					± 5.0
1,325,000,000					± 5.0
1,375,000,000					± 5.0
1,425,000,000					± 5.0
1,475,000,000					± 5.0
1,525,000,000					± 5.0
1,575,000,000					± 5.0
1,650,000,000					± 6.0
1,750,000,000					± 6.0
1,850,000,000					± 6.0
1,925,000,000					± 6.0
1,975,000,000					± 6.0
2,025,000,000					± 6.0
2,075,000,000					± 6.0
0.100 Vpp					
625,000,000					± 5.1
725,000,000					± 5.1
900,000,000					± 5.1
1,125,000,000					± 5.1
1,250,000,000					± 5.1
1,325,000,000					± 5.1
1,375,000,000					± 5.1
1,425,000,000					± 5.1
1,475,000,000					± 5.1
1,525,000,000					± 5.1

Table 8-4. Levelled Sinewave Verification: Flatness (cont.)

Calibrator Mainframe Freq. (MHz)	Measured Power Out (w)	10 MHz Power Out (w)	Deviation (w)	% Deviation	Calibrator Mainframe Flatness Spec. (%)
1,575,000,000					± 5.1
1,650,000,000					± 6.1
1,750,000,000					± 6.1
1,850,000,000					± 6.1
1,925,000,000					± 6.1
1,975,000,000					± 6.1
2,025,000,000					± 6.1
2,075,000,000					± 6.1
0.070 Vpp					
625,000,000					± 5.1
725,000,000					± 5.1
900,000,000					± 5.1
1,125,000,000					± 5.1
1,250,000,000					± 5.1
1,325,000,000					± 5.1
1,375,000,000					± 5.1
1,425,000,000					± 5.1
1,475,000,000					± 5.1
1,525,000,000					± 5.1
1,575,000,000					± 5.1
1,650,000,000					± 6.1
1,750,000,000					± 6.1
1,850,000,000					± 6.1
1,925,000,000					± 6.1
1,975,000,000					± 6.1
2,025,000,000					± 6.1
2,075,000,000					± 6.1
0.040 Vpp					
625,000,000					± 5.25
725,000,000					± 5.25
900,000,000					± 5.25
1,125,000,000					± 5.25

Table 8-4. Levelled Sinewave Verification: Flatness (cont.)

Calibrator Mainframe Freq. (MHz)	Measured Power Out (w)	10 MHz Power Out (w)	Deviation (w)	% Deviation	Calibrator Mainframe Flatness Spec. (%)
1,250,000,000					± 5.25
1,325,000,000					± 5.25
1,375,000,000					± 5.25
1,425,000,000					± 5.25
1,475,000,000					± 5.25
1,525,000,000					± 5.25
1,575,000,000					± 5.25
1,650,000,000					± 6.25
1,750,000,000					± 6.25
1,850,000,000					± 6.25
1,925,000,000					± 6.25
1,975,000,000					± 6.25
2,025,000,000					± 6.25
2,075,000,000					± 6.25
0.025 Vpp					
625,000,000					± 5.4
725,000,000					± 5.4
900,000,000					± 5.4
1,125,000,000					± 5.4
1,250,000,000					± 5.4
1,325,000,000					± 5.4
1,375,000,000					± 5.4
1,425,000,000					± 5.4
1,475,000,000					± 5.4
1,525,000,000					± 5.4
1,575,000,000					± 5.4
1,650,000,000					± 6.4
1,750,000,000					± 6.4
1,850,000,000					± 6.4
1,925,000,000					± 6.4
1,975,000,000					± 6.4
2,025,000,000					± 6.4

Table 8-4. Levelled Sinewave Verification: Flatness (cont.)

Calibrator Mainframe Freq. (MHz)	Measured Power Out (w)	10 MHz Power Out (w)	Deviation (w)	% Deviation	Calibrator Mainframe Flatness Spec. (%)
2,075,000,000					± 6.4
0.010 Vpp					
625,000,000					± 6.0
725,000,000					± 6.0
900,000,000					± 6.0
1,125,000,000					± 6.0
1,250,000,000					± 6.0
1,325,000,000					± 6.0
1,375,000,000					± 6.0
1,425,000,000					± 6.0
1,475,000,000					± 6.0
1,525,000,000					± 6.0
1,575,000,000					± 6.0
1,650,000,000					± 7.0
1,750,000,000					± 7.0
1,850,000,000					± 7.0
1,925,000,000					± 7.0
1,975,000,000					± 7.0
2,025,000,000					± 7.0
2,075,000,000					± 7.0
0.005 Vpp					
625,000,000					± 7.0
725,000,000					± 7.0
900,000,000					± 7.0
1,125,000,000					± 7.0
1,250,000,000					± 7.0
1,325,000,000					± 7.0
1,375,000,000					± 7.0
1,425,000,000					± 7.0
1,475,000,000					± 7.0
1,525,000,000					± 7.0
1,575,000,000					± 7.0

Table 8-4. Leveled Sinewave Verification: Flatness (cont.)

Calibrator Mainframe Freq. (MHz)	Measured Power Out (w)	10 MHz Power Out (w)	Deviation (w)	% Deviation	Calibrator Mainframe Flatness Spec. (%)
1,650,000,000					± 8.0
1,750,000,000					± 8.0
1,850,000,000					± 8.0
1,925,000,000					± 8.0
1,975,000,000					± 8.0
2,025,000,000					± 8.0
2,075,000,000					± 8.0

8-10. Leveled Sinewave Verification: Harmonics**Table 8-5. Leveled Sinewave Verification: Harmonics**

Harmonic	Nominal Value (V p-p)	Frequency	Measured Value (dB)	Deviation (dB)	1-Year Spec. (dB)
2nd harmonic	0.0399	10,000,000			-33
3rd+ harmonic	0.0399	10,000,000			-38
2nd harmonic	0.099	10,000,000			-33
3rd+ harmonic	0.099	10,000,000			-38
2nd harmonic	0.399	10,000,000			-33
3rd+ harmonic	0.399	10,000,000			-38
2nd harmonic	1.2	10,000,000			-33
3rd+ harmonic	1.2	10,000,000			-38
2nd harmonic	3.5	10,000,000			-33
3rd+ harmonic	3.5	10,000,000			-38
2nd harmonic	3.5	625,000,000			-33
3rd+ harmonic	3.5	625,000,000			-38
2nd harmonic	3.5	655,000,000			-33
3rd+ harmonic	3.5	655,000,000			-38
2nd harmonic	3.5	725,000,000			-33
3rd+ harmonic	3.5	725,000,000			-38
2nd harmonic	3.5	795,000,000			-33
3rd+ harmonic	3.5	795,000,000			-38
2nd harmonic	3.5	865,000,000			-33
3rd+ harmonic	3.5	865,000,000			-38
2nd harmonic	3.5	900,000,000			-33
3rd+ harmonic	3.5	900,000,000			-38
2nd harmonic	3.5	935,000,000			-33
3rd+ harmonic	3.5	935,000,000			-38
2nd harmonic	3.5	1,000,000,000			-33
3rd+ harmonic	3.5	1,000,000,000			-38
2nd harmonic	3.5	1,075,000,000			-33
3rd+ harmonic	3.5	1,075,000,000			-38
2nd harmonic	3.5	1,145,000,000			-33
3rd+ harmonic	3.5	1,145,000,000			-38

Table 8-5. Leveled Sinewave Verification: Harmonics (cont.)

Harmonic	Nominal Value (V p-p)	Frequency	Measured Value (dB)	Deviation (dB)	1-Year Spec. (dB)
2nd harmonic	3.5	1,250,000,000			-33
3rd+ harmonic	3.5	1,250,000,000			-38
2nd harmonic	3.5	1,285,000,000			-33
3rd+ harmonic	3.5	1,285,000,000			-38
2nd harmonic	3.5	1,375,000,000			-33
3rd+ harmonic	3.5	1,375,000,000			-38
2nd harmonic	3.5	1,425,000,000			-33
3rd+ harmonic	3.5	1,425,000,000			-38
2nd harmonic	3.5	1,475,000,000			-33
3rd+ harmonic	3.5	1,475,000,000			-38
2nd harmonic	3.5	1,500,000,000			-33
3rd+ harmonic	3.5	1,500,000,000			-38
2nd harmonic	3.5	1,525,000,000			-33
3rd+ harmonic	3.5	1,525,000,000			-38
2nd harmonic	3.5	1,600,000,000			-33
3rd+ harmonic	3.5	1,600,000,000			-38
2nd harmonic	3.5	1,650,000,000			-33
3rd+ harmonic	3.5	1,650,000,000			-38
2nd harmonic	3.5	1,750,000,000			-33
3rd+ harmonic	3.5	1,750,000,000			-38
2nd harmonic	3.5	1,850,000,000			-33
3rd+ harmonic	3.5	1,850,000,000			-38
2nd harmonic	3.5	1,930,000,000			-33
3rd+ harmonic	3.5	1,930,000,000			-38
2nd harmonic	3.5	1,980,000,000			-33
3rd+ harmonic	3.5	1,980,000,000			-38
2nd harmonic	3.5	2,030,000,000			-33
3rd+ harmonic	3.5	2,030,000,000			-38
2nd harmonic	3.5	2,080,000,000			-33
3rd+ harmonic	3.5	2,080,000,000			-38

Chapter 9

Accessories

	Title	Page
9-1.	Introduction.....	9-3
9-2.	Rack Mount Kit	9-3
9-3.	IEEE-488 Interface Cables	9-4
9-4.	RS-232 Null-Modem Cables	9-4
9-5.	RS-232 Modem Cables	9-4

9-1. Introduction

Table 9-1 summarizes the accessories available for use with the 5820A.

Table 9-1. Options and Accessories

Model	Description
689411	5820A Service Manual
5500/CAL	Calibration Software (RS-232 interface)
5500A/CASE	5500A Transit Case for calibrator
5500A/HNDL	5500A Side Handle for transporting the calibrator
	IEEE-488 interface for a PC National Instruments
943738	RS-232 Modem Cable, 2.44 m (8 ft) (SERIAL 2 TO UUT) to UUT (DB-9)
686318	5820A Operator Manual
MET/CAL	Calibration Software (IEEE-488 and RS-232 interface)
MET/TRACK	Metrology Asset Management Software
PM2295/05	IEEE-488 Cable, 0.5 m (1.64 ft)
PM2295/10	IEEE-488 Cable, 1 m (3.28 ft)
PM2295/20	IEEE-488 Cable, 2 m (6.56 ft)
PM8914/001	RS-232 Null Modem Cable, 1.5 m (5 ft) (SERIAL 1 FROM HOST) to PC COM (DB-9)
RS40	RS-232 Null Modem Cable, 1.83 m (6 ft) (SERIAL 1 FROM HOST) to PC COM (DB-25)
TC100	Test Instrument Cart
Y5537	24 in. (61 cm) Rack Mount Kit for 5500A/5800A/5820A
Y8021	Shielded IEEE-488 Cable 0.5m (1.64 ft)
Y8022	Shielded IEEE-488 Cable 2m (6.56 ft)
Y8023	Shielded IEEE-488 Cable 4m (13 ft)

9-2. Rack Mount Kit

The Y5537 rack mount kit provides all the hardware necessary to mount the 5820A on slides in a 24-inch (61 cm) equipment rack. Instructions are provided in the kit.

9-3. IEEE-488 Interface Cables

Shielded IEEE-488 cables are available in three lengths (See Table 9-1). The cables attach to the 5820A to any other IEEE-488 device. Each cable has double 24-pin connectors at both ends to allow stacking. Metric threaded mounting screws are provided with each connector. Appendix D shows the pinout for the IEEE-488 connector.

9-4. RS-232 Null-Modem Cables

The PM8914/001 and RS40 null modem cables connect the 5820A SERIAL 1 FROM HOST port to a printer, video display terminal, computer, or other serial device configured as DTE (Data Terminal Equipment). Appendix D shows the pinouts for the serial connectors.

9-5. RS-232 Modem Cables

The 943738 modem cable connects the 5820A SERIAL 2 TO UUT port to a unit under test serial port (with DB-9 male connector). Appendix D shows the pinouts for the serial connectors.

Appendices

Appendix	Title	Page
A	Glossary.....	A-1
B	ASCII and IEEE-488 Bus Codes	B-1
C	IEEE-488 Interface Card.....	C-1
D	RS-232/IEEE-488 Cables and Connectors.....	D-1
E	Creating a Visual Basic Test Program	E-1
F	Error Message	F-1

Appendix A

Glossary

adc (analog-to-digital converter)

A device or circuit that converts an analog signal to digital signals.

absolute uncertainty

Uncertainty specifications that include the error contributions made by all equipment and standards used to calibrate the instrument. Absolute uncertainty is the numbers to compare with the UUT for determining test uncertainty ratio.

accuracy

The degree to which the measured value of a quantity agrees with the true (correct) value of that quantity. For example, an instrument specified to ± 1 % uncertainty is 99 % accurate.

apparent power

The power value obtained by simply multiplying the ac current by the ac voltage on a circuit without consideration of any phase relationship between the two waveforms. (See “true power” for comparison.)

assert

To cause a digital signal to go into a logic true state.

af (audio frequency)

The frequency range of human hearing; normally 15 - 20,000 Hz.

artifact standard

An object that produces or embodies a physical quantity to be standardized, for example a Fluke 732A dc Voltage Reference Standard.

base units

Units in the SI system that are dimensionally independent. All other units are derived from base units. The only base unit in electricity is the ampere.

buffer

1. An area of digital memory for temporary storage of data.
2. An amplifier stage before the final amplifier.

burden voltage

The maximum sustainable voltage across the terminals of a load.

control chart

A chart devised to monitor one or more processes to detect the excessive deviation from a desired value of a component or process.

crest factor

The ratio of the peak voltage to the rms voltage of a waveform (with the dc component removed).

dac (digital-to-analog converter)

A device or circuit that converts a digital waveform to an analog voltage.

dBm

A reference power level of 1 mW expressed in decibels.

derived units

Units in the SI system that are derived from base units. Volts, ohms, and watts are derived from amperes and other base and derived units.

distortion

Undesired changes in the waveform of a signal. Harmonic distortion disturbs the original relationship between a frequency and other frequencies naturally related to it. Intermodulation distortion (imd) introduces new frequencies by the mixing of two or more original frequencies. Other forms of distortion are phase distortion and transient distortion.

errors

The different types of errors described in this glossary are “offset error,” “linearity error,” “random error,” “scale error,” “systematic errors,” and “transfer error.”

flatness

A measure of the variation of the actual output of an ac voltage source at different frequency points when set to the same nominal output level. A flat voltage source exhibits very little error throughout its frequency range.

floor

The part of the uncertainty specification of an instrument that is typically a fixed offset plus noise. Floor can be expressed as units, such as microvolts or counts of the least significant digit. For the 5820A, the floor specification is combined with fixed range errors in one term to determine total uncertainty.

full scale

The maximum reading of a range of a meter, analog-to-digital converter, or other measurement device, or the maximum attainable output on a range of a calibrator.

gain error

Same as scale error. Scale or gain error results when the slope of the meter's response curve is not exactly 1. A meter with only gain error (no offset or linearity error), will read 0 V with 0 V applied, but something other than 10 V with 10 V applied.

ground

The voltage reference point in a circuit. Earth ground is a connection through a ground rod or other conductor to the earth, usually accessible through the ground conductor in an ac power receptacle.

ground loops

Undesirable currents induced when there is more than one chassis ground potential in a system of instruments. Ground loops can be minimized by connecting all instruments in a system to ground to one point.

guard

See "voltage guard"

harmonics

A waveform that is an integral multiple of the fundamental frequency. For example, a waveform that is twice the frequency of a fundamental is called the second harmonic.

International Systems of Units

Same as "SI System of Units," the accepted system of units. See also "units," "base units," and "derived units."

legal units

The highest echelon in a system of units, for example the U.S. National Bureau of Standards volt.

life-cycle cost

The consideration of all elements contributing to the cost of an instrument throughout its useful life. This includes initial purchase cost, service and maintenance cost, and the cost of support equipment.

linearity

The relationship between two quantities when a change in the first quantity is directly proportional to a change in the second quantity.

linearity error

Linearity error occurs when the response curve of a meter is not exactly a straight line. This type of error is measured by fixing two points on the response curve, drawing a line through the points, then measuring how far the curve deviates from the straight line at various points in the response curve.

MAP (Measurement Assurance Program)

A program for measurement process. A MAP provides information to demonstrate that the total uncertainty of the measurements (data), including both random error and systematic components of error relative to national or other designated standards is quantified, and sufficiently small to meet requirements.

MTBF (Mean Time Between Failures)

The time interval in operating hours that can be expected between failure of equipment. MTBF can be calculated from direct observation or mathematically derived through extrapolation.

MTTF (Mean Time To Fail)

The time interval in operating hours that can be expected until the first failure of equipment. MTTF can be calculated from direct observation or mathematically derived through extrapolation.

MTTR (Mean Time to Repair)

The average time in hours required to repair failed equipment.

metrology

The science of, and the field of knowledge concerned with measurement.

minimum use specifications

A compilation of specifications that satisfies the calibration requirements of a measurement system or device. The minimum use specifications are usually determined by maintaining a specified test uncertainty ratio between the calibration equipment and the unit under test.

noise

A signal containing no useful information that is superimposed on a desired or expected signal.

normal mode noise

An undesired signal that appears between the terminals of a device.

offset error

Same as zero error. The reading shown on a meter when an input value of zero is applied is its offset or zero error.

parameters

Independent variables in a measurement process such as temperature, humidity, test lead resistance, etc.

precision

The precision of a measurement process is the coherence, or the closeness to the one result, of all measurement results. High precision, for example would result in a tight pattern of arrow hits on a target, without respect to where on the target the tight pattern falls.

predictability

A measure of how accurately the output value of a device can be assumed after a known time following calibration. If a device is highly stable, it is also predictable. If a device is not highly stable, but its value changes at the same rate every time after calibration, its output has a higher degree of predictability than a device that exhibits random change.

primary standard

A standard defined and maintained by some authority and used to calibrate all other secondary standards.

process metrology

Tracking the accuracy drift of calibration and other equipment by applying statistical analysis to correction factors obtained during calibration.

random error

Any error which varies in an unpredictable manner in absolute value and in sign when measurements of the same value of a quantity are made under effectively identical conditions.

range

The stated upper end of a measurement device's span. Usually, however, a measurement device can measure quantities for a specified percentage overrange. (The absolute span including overrange capability is called "scale.") In the 5820A, however, range and scale are identical.

reference amplifier

DC voltage references developed for the 5820A. These are 6.9 V devices consisting of a zener diode and a transistor. These reference amplifiers exhibit extremely low uncertainty and drift, and are superior to zener diode or temperature-compensated zener diode voltage references.

reference standard

The highest-echelon standard in a laboratory; the standard that is used to maintain working standards that are used in routine calibration and comparison procedures.

relative uncertainty

5820A uncertainty specifications that exclude the effects of external dividers and standards, for use when range constants are adjusted. Relative uncertainty includes only the stability, temperature coefficient, noise, and linearity specifications of the 5820A itself.

reliability

A measure of the “uptime” of an instrument.

repeatability

The degree of agreement among independent measurements of a quantity under the same conditions.

resistance

A property of a conductor that determines the amount of current that will flow when a given amount of voltage exists across the conductor. Resistance is measured in ohms. One ohm is the resistance through which one volt of potential will cause one ampere of current to flow.

resolution

The smallest change in quantity that can be detected by a measurement system or device. For a given parameter, resolution is the smallest increment that can be measured, generated, or displayed.

rf (radio frequency)

The frequency range of radio waves; from 150 kHz up to the infrared range.

rms (root-mean-square)

The value assigned to an ac voltage or current that results in the same power dissipation in a resistance as a dc current or voltage of the same value.

rms sensor

A device that converts ac voltage to dc voltage with great accuracy. RMS sensors operate by measuring the heat generated by a voltage through a known resistance (i.e., power); therefore, they sense true rms voltage.

scale

The absolute span of the reading range of a measurement device including overrange capability.

scale error

Same as gain error. Scale or gain error results when the slope of the meter's response curve is not exactly 1. A meter with only scale error (no offset or linearity error), will read 0 V with 0 V applied, but something other than 10V with 10V applied.

secondary standard

A standard maintained by comparison against a primary standard.

sensitivity

The degree of response of a measuring device to the change in input quantity, or a figure of merit that expresses the ability of a measurement system or device to respond to an input quantity.

shield

A grounded covering device designed to protect a circuit or cable from electromagnetic interference.

SI System of Units

The accepted International System of Units. See also "units," "base units," and "derived units."

specifications

A precise statement of the set of requirements satisfied by a measurement system or device.

stability

A measure of the freedom from drift in value over time and over changes in other variables such as temperature. Note that stability is not the same as uncertainty.

standard

A device that is used as an exact value for reference and comparison.

standard cell

A primary cell that serves as a standard of voltage. The term "standard cell" often refers to a "Weston normal cell," which is a wet cell with a mercury anode, a cadmium mercury amalgam cathode, and a cadmium sulfate solution as the electrolyte.

systematic errors

Errors in repeated measurement results that remain constant or vary in a predictable way.

temperature coefficient

A factor per °C deviation from a nominal value or range that the uncertainty of an instrument increases. This specification is necessary to account for the thermal coefficients in a calibrator's analog circuitry.

test uncertainty ratio

The numerical ratio of the uncertainty of the measurement system or device being calibrated to the uncertainty of the measurement system or device used as the calibrator. (Also called "test accuracy ratio.")

thermal emf

The voltage generated when two dissimilar metals joined together are heated.

traceability

The ability to relate individual measurement results to national standards or nationally accepted measurement systems through an unbroken chain of comparisons, i.e., a calibration “audit trail.”

Measurements, measurement systems or devices have traceability to the designated standards if and only if scientifically rigorous evidence is produced in a continuing basis to show that the measurement process is producing measurement results for which the total measurement uncertainty relative to national or other designated standards is qualified.

transfer error

The sum of all new errors induced during the process of comparing one quantity against another.

transfer standard

Any working standard used to compare a measurement process, system, or device at one location or level with another measurement process, system, or device at another location or level.

transport standard

A transfer standard that is rugged enough to allow shipment by common carrier to another location.

true power

The actual power (real power) used to produce heat or work. Compare to ‘apparent power.’”

true value

Also called legal value, the accepted, consensus, i.e., the correct value of the quantity being measured.

uncertainty

The maximum difference between the accepted, consensus, or true value and the measured value of a quantity. Uncertainty is normally expressed in units of ppm (parts per million) or as a percentage.

units

Symbols or names that define the measured quantities. Examples of units are: V, mV, A, kW, and dBm. See also “SI System of Units.”

UUT (Unit Under Test)

An abbreviated name for an instrument that is being tested or calibrated.

var

Symbol for voltampere reactive, the unit of reactive power, as opposed to real power in watts.

verification

Checking the functional performance and uncertainty of an instrument or standard without making adjustments to it or changing its calibration constants.

volt

The unit of emf (electromotive force) or electrical potential in the SI system of units. One volt is the difference of electrical potential between two points on a conductor carrying one ampere of current, when the power being dissipated between these two points is equal to one watt.

voltage guard

A floating shield around voltage measurement circuitry inside an instrument. The voltage guard provides a low-impedance path to ground for common-mode noise and ground currents, thereby eliminating errors introduced by such interference.

watt

The unit of power in the SI system of units. One watt is the power required to do work at the rate of one joule/second. In terms of volts and ohms, one watt is the power dissipated by one ampere flowing through a one-ohm load.

working standard

A standard that is used in routine calibration and comparison procedures in the laboratory, and is maintained by comparison to reference standards.

zero error

Same as offset error. The reading shown on a meter when an input value of zero is applied is its zero or offset error.

Appendix B
ASCII and IEEE-488 Bus Codes

ASCII CHAR.	DECIMAL	OCTAL	HEX	BINARY 7654 3210	DEV. NO.	MESSAGE ATN=TRUE	ASCII CHAR.	DECIMAL	OCTAL	HEX	BINARY 7654 3210	DEV. NO.	MESSAGE ATN=TRUE
NUL	0	000	00	0000 0000			@	64	100	40	0100 0000	0	MTA
SQH	1	001	01	0000 0001			A	65	101	41	0100 0001	1	MTA
STX	2	002	02	0000 0010		GTL	B	66	102	42	0100 0010	2	MTA
ETX	3	003	03	0000 0011			C	67	103	43	0100 0011	3	MTA
EOT	4	004	04	0000 0100			D	68	104	44	0100 0100	4	MTA
ENQ	5	005	05	0000 0101		SDC PPC	E	69	105	45	0100 0101	5	MTA
ACH	6	006	06	0000 0110			F	70	106	46	0100 0110	6	MTA
BELL	7	007	07	0000 0111			G	71	107	47	0100 0111	7	MTA
BS	8	010	08	0000 1000			H	72	110	48	0100 1000	8	MTA
HT	9	011	09	0000 1001		GET TCT	I	73	111	49	0100 1001	9	MTA
LF	10	012	0A	0000 1010			J	74	112	4A	0100 1010	10	MTA
VT	11	013	0B	0000 1011			K	75	113	4B	0100 1011	11	MTA
FF	12	014	0C	0000 1100			L	76	114	4C	0100 1100	12	MTA
CR	13	015	0D	0000 1101			M	77	115	4D	0100 1101	13	MTA
SO	14	016	0E	0000 1110			N	78	116	4E	0100 1110	14	MTA
SI	15	017	0F	0000 1111			O	79	117	4F	0100 1111	15	MTA
DLE	16	020	10	0001 0000			P	80	120	50	0101 0000	16	MTA
DC1	17	021	11	0001 0001		LLO	Q	81	121	51	0101 0001	17	MTA
DC2	18	022	12	0001 0010			R	82	122	52	0101 0010	18	MTA
DC3	19	023	13	0001 0011			S	83	123	53	0101 0011	19	MTA
DC4	20	024	14	0001 0100		DCL PPU	T	84	124	54	0101 0100	20	MTA
NAK	21	025	15	0001 0101			U	85	125	55	0101 0101	21	MTA
SYN	22	026	16	0001 0110			V	86	126	56	0101 0110	22	MTA
ETB	23	027	17	0001 0111			W	87	127	57	0101 0111	23	MTA
CAN	24	030	18	0001 1000		SPE SPD	X	88	130	58	0101 1000	24	MTA
EM	25	031	19	0001 1001			Y	89	131	59	0101 1001	25	MTA
SUB	26	032	1A	0001 1010			Z	90	132	5A	0101 1010	26	MTA
ESC	27	033	1B	0001 1011			[91	133	5B	0101 1011	27	MTA
FS	28	034	1C	0001 1100			\	92	134	5C	0101 1100	28	MTA
GS	29	035	1D	0001 1101]	93	135	5D	0101 1101	29	MTA
RS	30	036	1E	0001 1110			^	94	136	5E	0101 1110	30	MTA
US	31	037	1F	0001 1111			_	95	137	5F	0101 1111	30	MTA UNT
SPACE	32	040	20	0010 0000	0	MLA	,	96	140	60	0111 0000	0	MSA
!	33	041	21	0010 0001	1	MLA	a	97	141	61	0111 0001	1	MSA
"	34	042	22	0010 0010	2	MLA	b	98	142	62	0111 0010	2	MSA
#	35	043	23	0010 0011	3	MLA	c	99	143	63	0111 0011	3	MSA
\$	36	044	24	0010 0100	4	MLA	d	100	144	64	0111 0100	4	MSA
%	37	045	25	0010 0101	5	MLA	e	101	145	65	0111 0101	5	MSA
&	38	046	26	0010 0110	6	MLA	f	102	146	66	0111 0110	6	MSA
'	39	047	27	0010 0111	7	MLA	g	103	147	67	0111 0111	7	MSA
(40	050	28	0010 1000	8	MLA	h	104	150	68	0111 1000	8	MSA
)	41	051	29	0010 1001	9	MLA	i	105	151	69	0111 1001	9	MSA
*	42	052	2A	0010 1010	10	MLA	j	106	152	6A	0111 1010	10	MSA
+	43	053	2B	0010 1011	11	MLA	k	107	153	6B	0111 1011	11	MSA
,	44	054	2C	0010 1100	12	MLA	l	108	154	6C	0111 1100	12	MSA
-	45	055	2D	0010 1101	13	MLA	m	109	155	6D	0111 1101	13	MSA
.	46	056	2E	0010 1110	14	MLA	n	110	156	6E	0111 1110	14	MSA
/	47	057	2F	0010 1111	15	MLA	o	111	157	6F	0111 1111	15	MSA
0	48	060	30	0011 0000	16	MLA	p	112	160	70	0111 0000	16	MSA
1	49	061	31	0011 0001	17	MLA	q	113	161	71	0111 0001	17	MSA
2	50	062	32	0011 0010	18	MLA	r	114	162	72	0111 0010	18	MSA
3	51	063	33	0011 0011	19	MLA	s	115	163	73	0111 0011	19	MSA
4	52	064	34	0011 0100	20	MLA	t	116	164	74	0111 0100	20	MSA
5	53	065	35	0011 0101	21	MLA	u	117	165	75	0111 0101	21	MSA
6	54	066	36	0011 0110	22	MLA	v	118	166	76	0111 0110	22	MSA
7	55	067	37	0011 0111	23	MLA	w	119	167	77	0111 0111	23	MSA
8	56	070	38	0011 1000	24	MLA	x	120	170	78	0111 1000	24	MSA
9	57	071	39	0011 1001	25	MLA	y	121	171	79	0111 1001	25	MSA
:	58	072	3A	0011 1010	26	MLA	z	122	172	7A	0111 1010	26	MSA
;	59	073	3B	0011 1011	27	MLA	{	123	173	7B	0111 1011	27	MSA
<	60	074	3C	0011 1100	28	MLA		124	174	7C	0111 1100	28	MSA
=	61	075	3D	0011 1101	29	MLA	}	125	175	7D	0111 1101	29	MSA
>	62	076	3E	0011 1110	30	MLA	~	126	176	7E	0111 1110	30	MSA
?	63	077	3F	0011 1111	31	UNL		127	177	7F	0111 1111	31	UNS

Appendix C

IEEE-488 Interface Card

IEEE-488 Interface Card

Refer to the National Instruments documentation for swithc settings and setup information. The National Instruments 488 Interface card must be 32-bit compatable.

Appendix D

RS-232/IEEE-488 Cables and Connectors

IEEE-488 Connector

The IEEE-488 connector on the rear panel mates with an IEEE-488 standard cable. The pin assignments of the rear-panel IEEE-488 connector are shown in Figure D-1. IEEE-488 connection cables are available from Fluke as shown in Table D-1. See Chapter 9 for ordering information.

Table D-1. IEEE-488 Connection Cables

IEEE-488 Connection Cable	Fluke Part Number
0.5 m (1.64 feet)	PM2295/05
1 m (3.28 feet)	PM2295/10
2 m (6.56 feet)	PM2295/20

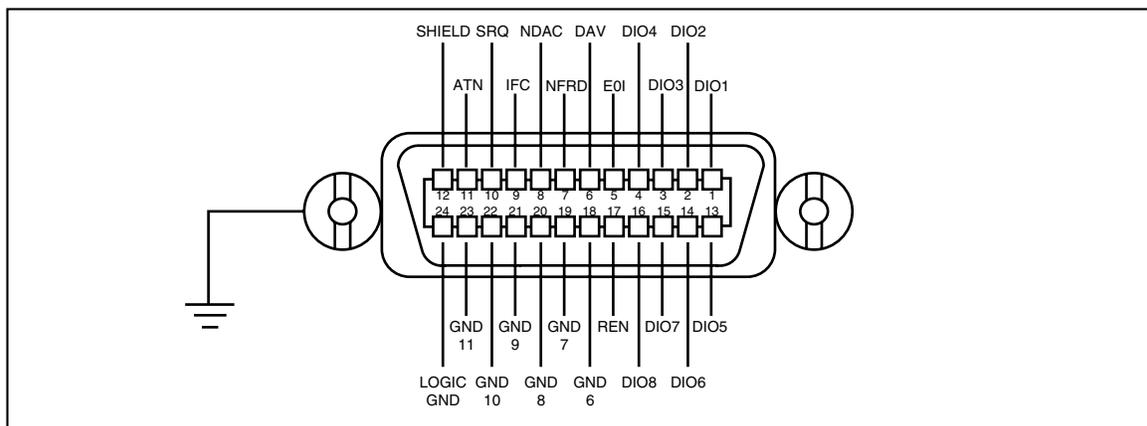

Figure D-1. IEEE-488 Connector Pinout (connection side)

oq048f.eps

Serial Connectors

The two 9-pin serial connectors on the rear panel of the 5820A Calibrator are used to interface with a computer, or controller, and an instrument serial port. The pin assignments of the rear-panel serial connectors are in conformance to EIA/TIA-574 standard and are shown in Figures D-1 (Host) and D-2 (UUT).

Serial connection cables are available from Fluke are shown in Table D-2. See Chapter 9 for ordering information.

Table D-2. Serial Port Connection Cables

Connection Cable		Fluke Part Number
5820A SERIAL 1 FROM HOST	PC COM port (DB-9)	PM8914/001
5820A SERIAL 1 FROM HOST	PC COM port (DB-25)	RS40
5820A SERIAL 2 TO UUT	UUT serial port (DB-9)	943738
5820A SERIAL 2 TO UUT	UUT serial port (DB-25)	n/a

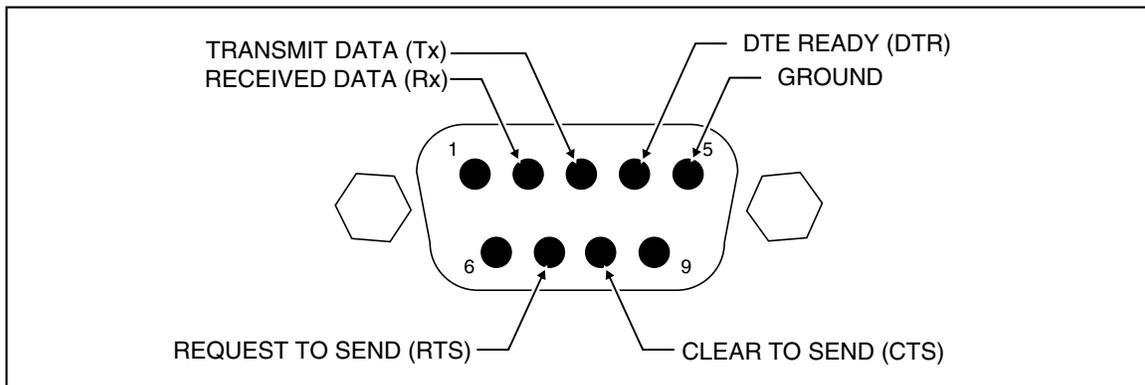

Figure D-2. SERIAL 1 FROM HOST Port Connector Pinout

oq049f.eps

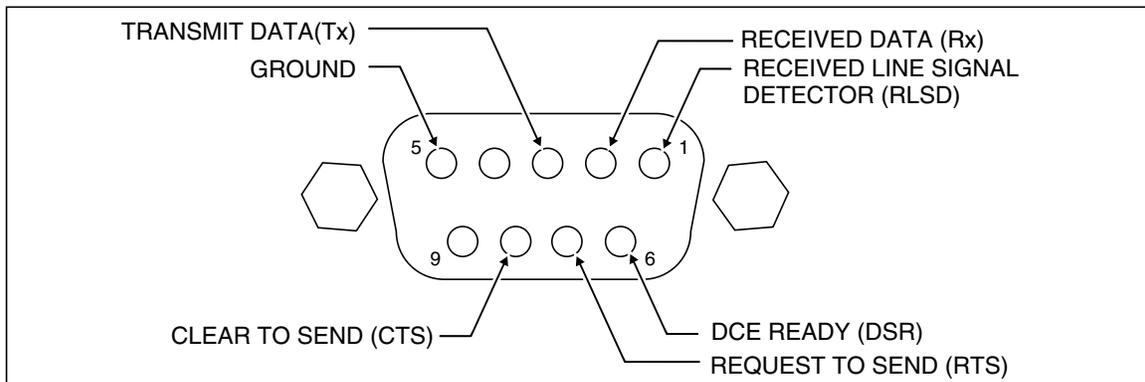

Figure D-3. SERIAL 2 TO UUT Port Connector Pinout (connection side)

oq050f.eps

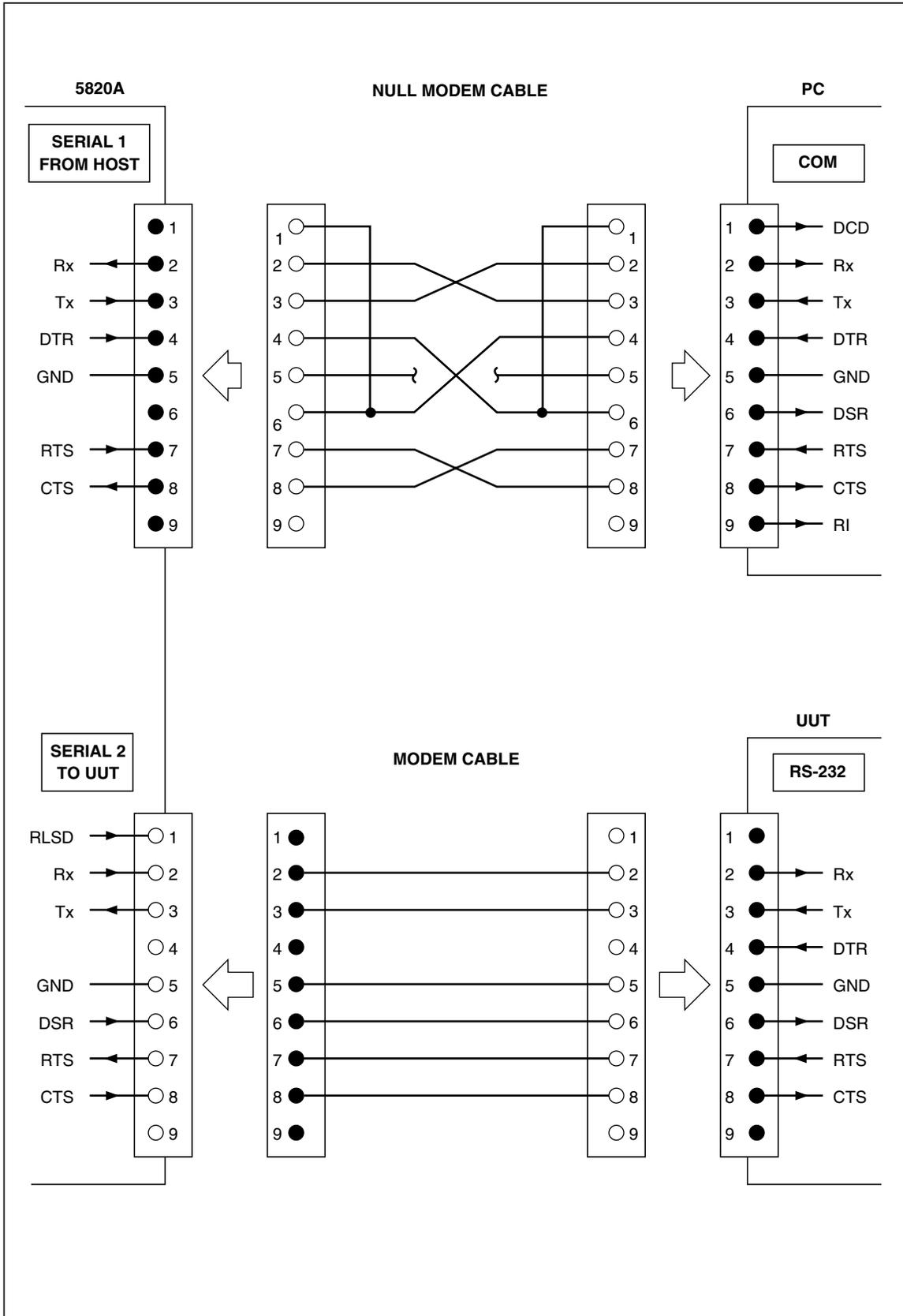

Figure D-4. Serial Port Connections (DB-9/DB-9)

yh051f.eps

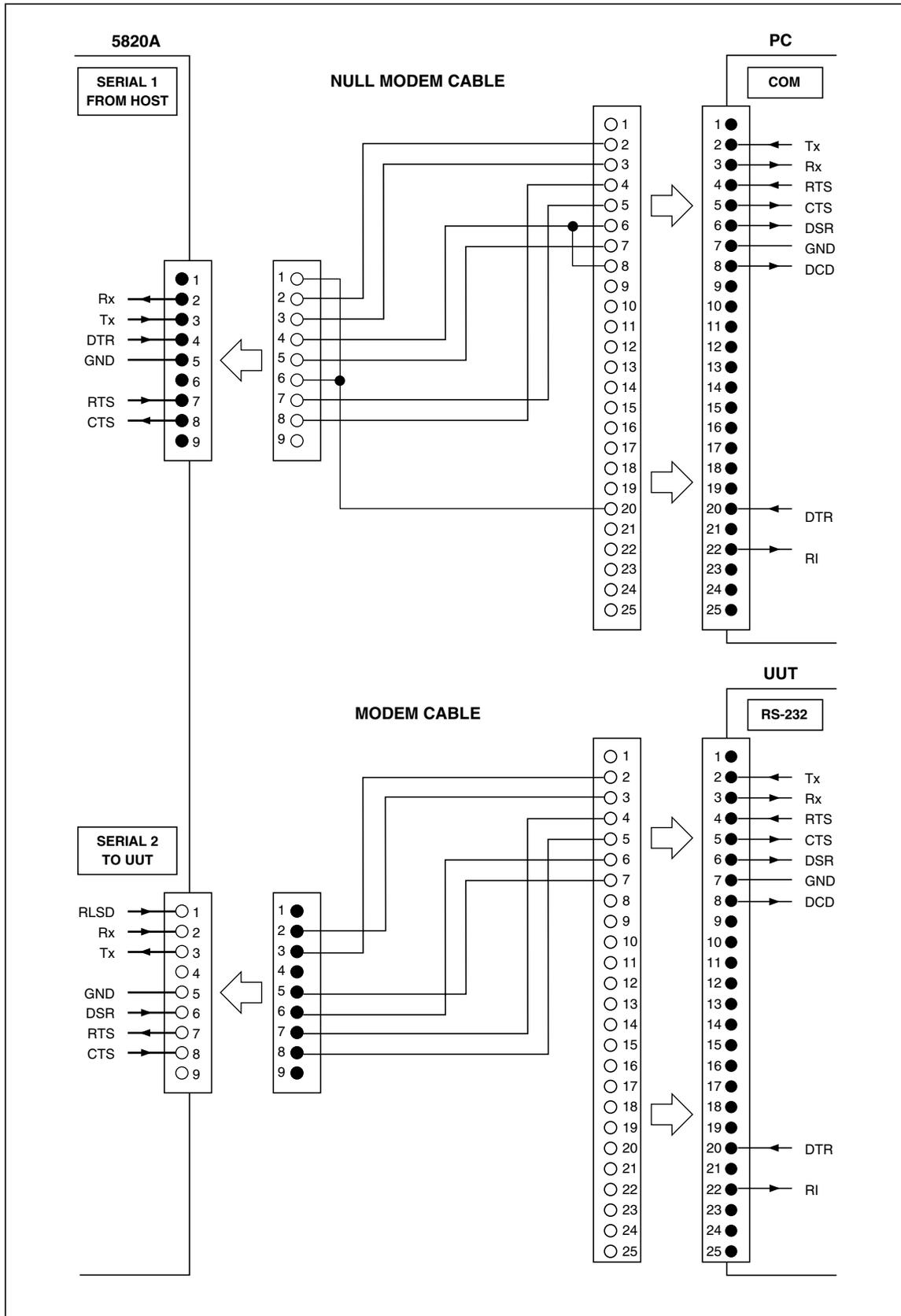

Figure D-5. Serial Port Connections (DB-9/DB-25)

yh052f.eps

Appendix E

Creating a Visual Basic Test Program

Creating a Visual Basic Test Program

The following procedure creates a test program in Visual Basic that you may use to test 5820A Calibrator RS-232 Host port and RS-232 UUT port operation. This procedure assumes you have access to the Custom Control Icons in your edition of Visual Basic, and creates the least complicated program for RS-232 testing.

Complete the following procedure to create an RS-232 test program in Visual Basic.

1. Open Microsoft Visual Basic from the Visual Basic group, displaying the Form1 screen (below).

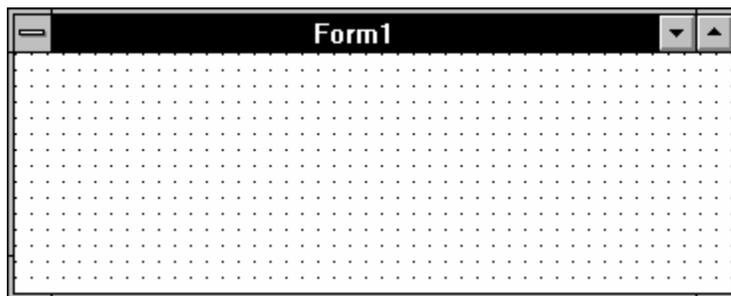

oq053f.bmp

2. From the Toolbox, double click the Command icon , creating a Command1 button on the Form1 screen. Repeat, creating a Command2 button. Repeat again creating a Command3 button.

3. Separate the Command buttons and resize the form for ease of use (below is typical).

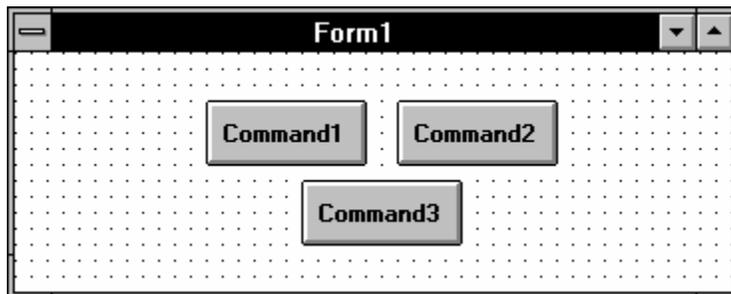

ff-0a.bmp

4. From the Toolbox, double click the Communications icon , placing the icon on the Form1 screen. This custom control icon provides complete serial communications capabilities for this program. Position the icon anywhere on the Form1 screen that is convenient.
5. Double click on a clear area of the Form1 screen to open the Code window for Form1. Enter the code shown below. If using COM2 on the PC, change the command to `Comm1.CommPort = 2`. If not using the factory default settings for the RS-232 ports, then change the command `Comm1.Settings` as required.

```
Sub Form_Load ()  
Comm1.CommPort = 1 [if using COM2, enter = 2]  
Comm1.Settings = "9600,N,8,1" [baud, parity, data, stop]  
Comm1.PortOpen = True  
End Sub
```

6. While still in the Code window, select Command1 from the Object list. Enter the code shown below. The `Chr(10)` means ASCII character 10 (line feed).

```
Sub Command1_Click ()  
Comm1.Output = "REMOTE" + Chr(10)  
End Sub
```

7. Select Command2 from the Object list. Enter the code shown below.

```
Sub Command2_Click ()  
Comm1.Output = "LOCAL" + Chr(10)  
End Sub
```

8. Select Command3 from the Object list. Enter the code shown below, where `<uut command>` is the command you selected for the UUT response.

```
Sub Command3_Click ()  
Comm1.Output = "UUT_SEND ""<uut command>"" " + Chr(10)  
End Sub
```

For example, `"UUT_SEND ""REMS\n"" "`. Note the use of `\n`, which indicates a Carriage Return (CR) as the end-of-line character. Other characters include `\r` (Line Feed), `\t` (Tab), `\b` (Backspace) and `\f` (Form Feed). Also note the double quotes around `<uut command>` to show embedded quotes.

9. On the Visual Basic Toolbar, click the Start button  to run the RS-232 test program (below is typical). If there are no errors, continue to Step 10.

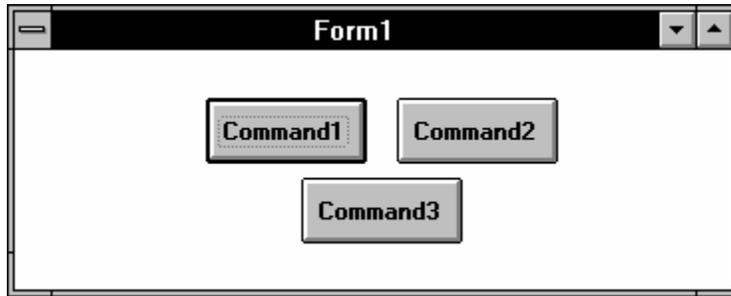

ff-0D.bmp

10. Click the Stop button  on the Toolbar to stop the program.
 (Hint: Before continuing to the next step, connect the 5820A Calibrator and UUT (if applicable) and test the program in actual operation.)
11. Save the program as `vb_rs232.exe` by selecting the Make EXE File command from the File menu. Save the program files by selecting the Save Program command from the File menu.
12. Select the Exit command from the File menu to exit Visual Basic.
13. In Program Manager, select New from the File menu. Check Program Group, then click OK. In the Description box, enter RS-232 Test then click OK. This creates and opens the RS-232 Test group.
14. With the RS-232 Test group still open, select New from the File menu. Check Program Item, then click OK. In the Description box, enter Test Ports. Use Browse to locate your `vb_rs232.exe` file, then click OK to enter this file in the Command Line box. Click OK. This creates the Test Ports icon (below).

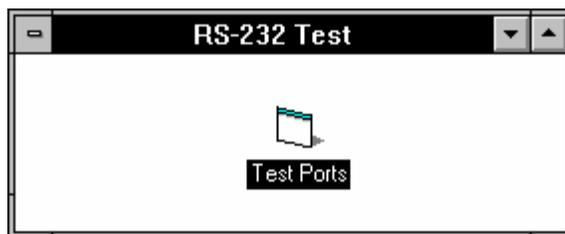

oq060f.bmp

Appendix F

Error Message

Error Messages

The following is a list of the 5820A Calibrator error messages. The error message format is shown in Table F-1.

Table F-1. Error Message Format

Error Number	Text characters	Syntax	(Message Class : Description)	
0 to 65535	Up to 36 text characters	Abbreviated text message	QYE Query Error, caused by a full input buffer, unterminated action or interrupted action	F Error is displayed on the front panel as it occurs
			DDE Device-Specific Error, caused by the 5820A due to some condition, for example, overrange	R Error is queued to the remote interface as it occurs
			EXE Execution Error, caused by an element outside of, or inconsistent with, the 5820A capabilities	S Error causes instrument to go to Standby
			CME Command Error, caused by incorrect command syntax, unrecognized header, or parameter of the wrong type	D Error causes instrument returns to the power up state
			B - Error is displayed on both the front panel and remote interface as it occurs.	(none) Error is returned to the initiator only (i.e., local initiator or remote initiator)

0	NONE	"No Error"	0
1	QOVFLOW	"Error queue overflow"	B DDE
100	GX_SYNC_SEND	"Inguard not responding (send) "	B D DDE
101	GX_SYNC_RECV	"Inguard not responding (recv) "	B D DDE
102	GX_SYNC_SBYTE	"Lost sync with inguard"	B D DDE
103	GX_CMD	"Invalid guard xing command"	B DDE
104	GX_TRIP	"Hardware relay trip occurred"	B D DDE
105	GX_TIME	"Inguard got impatient"	B D DDE
106	GX_AD	"A/D fell asleep"	B D DDE
107	GX_DOG	"Inguard watchdog timeout"	B D DDE
108	GX_I GOBS	"Inguard is obsolete"	B DDE
109	IG_PARITY	"Inguard parity error"	B D DDE
110	IG_OVERRUN	"Inguard overrun error"	B D DDE
111	IG_FRAMING	"Inguard framing error"	B D DDE
112	IG_FAULT	"Inguard fault error"	B D DDE
113	IG_FAULT_INPUT	"Inguard fault input error"	B D DDE
114	IG_FAULT_DET	"Inguard fault detect error"	B D DDE
115	IG_READWRITE	"Inguard read/write error"	B D DDE
300	CAL_PROC	"Invalid procedure number"	DDE
301	CAL_STEP	"No such step in procedure"	DDE
302	CAL_BUSY	"Can't change that while busy"	DDE
303	CAL_ENTRY	"Can't begin/resume cal there"	DDE
304	CAL_REFUNIT	"Wrong unit for reference"	DDE
305	CAL_REFVAL	"Entered value out of bounds"	DDE
306	CAL_NOREFNOW	"Not waiting for a reference"	DDE
307	CAL_NOCONTNOW	"Continue command ignored"	DDE
308	CAL_LIMIT	"Cal constant outside limits"	B DDE
309	CAL_NULL	"Cal try to null failed"	B DDE
310	CAL_SEQ	"Sequence failed during cal"	B D DDE
311	CAL_MEAS	"A/D measurement failed"	B D DDE
312	CAL_PARAM	"Invalid cal step parameter"	B DDE
313	CAL_SWITCH	"Cal switch must be ENABLED"	DDE
314	CAL_MATH	"Divide by zero encountered"	B DDE
315	CAL_OPER	"Must be in OPER at this step"	B DDE
317	CAL_BADZ	"Bad reference Z or entry"	B DDE
318	CAL_DACLIMIT	"Cal takes DAC over top limit"	B DDE
399	CAL_WHEN	"Fault during %s"	F
400	EPD_PROTOCOL0	"Encoder not responding VERS"	B D DDE
401	EPD_PROTOCOL1	"Encoder not responding COMM"	B D DDE
402	EPD_PROTOCOL2	"Encoder not responding STAT"	B D DDE
403	EPD_SELFTEST	"Encoder self-test failed"	B DDE
405	EPD_OFFDISP	"Message over display R side"	B DDE
406	EPD_CHARMAP	"Unmappable character %#d"	B DDE
407	EPD_NORESET	"Encoder did not reset"	B DDE
408	EPD_CMDERR	"Encoder got invalid command"	B DDE
409	EPD_RESET	"Encoder unexpectedly reset"	B D DDE
500	STA_CONFUSED	"Internal state error"	DDE
501	STA_BADENUM	"Invalid keyword or choice"	DDE
503	STA_NEGF	"Frequency must be >= 0"	DDE
504	STA_NEGAC	"AC magnitude must be > 0"	DDE
505	STA_NEGZ	"Impedance must be >= 0"	DDE
506	STA_NOFUNC	"Function not available"	DDE
507	STA_NORANGE	"Value not available"	DDE
512	STA_EDITLINE	"Can't select that field now"	DDE

513	STA_EDITDIGIT	"Edit digit out of range"	DDE
514	STA_EDITCHG	"Can't switch edit field now"	DDE
515	STA_NOTEDITING	"Not editing output now"	DDE
516	STA_BADDBMTIME	"dBm not available now"	DDE
518	STA_OVERLOCK	"Value outside locked range"	DDE
519	STA_NOUNIT	"Must specify an output unit"	DDE
520	STA_TOOMANYF	"Can't do two freqs at once"	DDE
521	STA_THREEMAGS	"Can't source 3 values at once"	DDE
523	STA_NOCANDO	"Can't do that now"	DDE
527	STA_NOCHANGES	"No changes except RESET now"	DDE
529	STA_EDITACDC	"Cannot edit to or from 0 Hz"	DDE
530	STA_IMAGE	"Bad state image - not loaded"	DDE
533	STA_SET_OFFSET	"Can't set an offset now"	DDE
534	STA_SET_RNGLCK	"Can't lock this range"	DDE
536	STA_SET_WAVE	"Can't set wave now"	DDE
543	STA_EPD	"STA couldn't update OTD"	D DDE
545	STA_NOEDIT	"Can't edit now"	DDE
546	STA_SET_TRIG	"Can't set trigger to that now"	DDE
547	STA_SET_OZ	"Can't set output imp. now"	DDE
549	STA_NEGTIME	"Period must be >= 0"	DDE
550	STA_RPTRUN	"A report is already printing"	DDE
553	STA_SET_TMWAVE	"Can't set marker shape now"	DDE
554	STA_SET_VIDEO	"Can't set video parameter now"	DDE
555	STA_BADVIDMARK	"Marker location out of range"	DDE
556	STA_BADPWIDTH	"Pulse width must be 1 - 255"	DDE
557	STA_SETTRNGFUNC	"Can't set range directly now"	DDE
558	STA_SETTRNGRNG	"Not a range for this function"	DDE
559	STA_SETTDPULSE	"Can't set TD pulse now"	DDE
560	STA_ZEROMEAS	"ZERO_MEAS only for C meas"	DDE
563	STA_TLIMIT	"Time limit must be 1s-60s"	DDE
565	STA_OPT_5	"5820A-5 option not installed"	DDE
566	STA_NOFREQ	"Cannot enter frequency now"	DDE
600	MAIN_WATCHDOG	"Outguard watchdog timeout"	B D DDE
601	MAIN_RAMTEST	"Power-up RAM test failed"	B DDE
602	MAIN_GPIBTEST	"Power-up GPIB test failed"	B DDE
700	NV_RECORD	"Saving to NV memory failed"	R DDE
701	NV_EMPTY	"NV memory invalid"	R DDE
702	NV_DEFAULTS	"NV invalid so default loaded"	R DDE
703	NV_OUTOFDATE	"NV obsolete so default loaded"	R DDE
800	SER_PARITY	"Serial parity error %s"	B DDE
801	SER_FRAMING	"Serial framing error %s"	B DDE
802	SER_OVERRUN	"Serial overrun error %s"	B DDE
803	SER_DROPPED	"Serial characters dropped %s"	B DDE
900	STA_NO_VALUES	"Cannot enter a value in this mode" to be displayed on front panel, error message must stop here>.	DDE
901	STA_NO_SACVF	"Try F betw. 10 Hz & 10 kHz"	DDE
902	STA_NO_SACVV	"Try V betw. 1 mV & 130V "	DDE
903	STA_NO_SDCVV	"Try V < 130 V"	DDE
904	STA_NO_SGF	"Try F betw. .01 Hz & 100 kHz"	DDE
905	STA_NO_SGV50	"Try V betw 1.8mV & 2.5V"	DDE
906	STA_NO_SGV1M	"Try V betw 1.8mV & 55V"	DDE
907	STA_NO_SEF	"Try F betw. 900 Hz & 11 MHz"	DDE
908	STA_NO_SEV	"Try V betw. 3.6 mV & 2.75V"	DDE
909	STA_NO_SLF	"Try F betw. 50 kHz & 600 MHz"	DDE
910	STA_NO_SLV	"Try V betw. 5 mV & 5.5V"	DDE

911	STA_NO_SMV	"Try T betw. 1.8 ns & 5s"	DDE
912	STA_NO_SVV	"Try video ampl < 150%"	DDE
913	STA_NO_SPW	"Try width betw. 2 & 500 ns"	DDE
914	STA_NO_SPP	"Try T betw. 200 ns & 22 ms"	DDE
915	STA_NO_SOV	"Try V betw. 5V & 9V"	DDE
		to be displayed on front panel, error message must stop here>.	
1000	DIAG_SEQ	"Sequence failed during diag"	B DDE
1001	DIAG_GX	"Guard xing link diag fail"	B DDE
1002	DIAG_IGBUS	"Inguard bus r/w diag fail"	B DDE
1300	REM_SYNTAX	"Bad syntax"	R CME
1301	REM_BADCMD	"Unknown command"	R CME
1302	REM_ARGC	"Bad parameter count"	R CME
1303	REM_ARGK	"Bad keyword"	R CME
1304	REM_ARGT	"Bad parameter type"	R CME
1305	REM_ARGU	"Bad parameter unit"	R CME
1306	REM_ARGV	"Bad parameter value"	R EXE
1307	REM_DEADLCK	"488.2 I/O deadlock"	R QYE
1308	REM_INTRD	"488.2 interrupted query"	R QYE
1309	REM_UNTERM	"488.2 unterminated command"	R QYE
1310	REM_QAIR	"488.2 query after indefinite response"	R QYE
1311	REM_NOGPIB	"Invalid from GPIB interface"	R DDE
1312	REM_NOSER	"Invalid from serial interface"	R DDE
1313	REM_WIZONLY	"Service only"	R DDE
1314	REM_ARGSIZE	"Parameter too long"	R EXE
1315	REM_BADGET	"Invalid device trigger"	R CME
1316	REM_DDTREC	"Device trigger recursion"	R EXE
1317	REM_SERBFULL	"Serial buffer full"	R CME
1318	REM_BADNUM	"Bad number"	R EXE
1319	REM_WIZFAILURE	"Service command failed"	R EXE
1320	REM_LEX_BIN	"Bad binary number"	R CME
1321	REM_LEX_BLK	"Bad binary block"	R CME
1322	REM_LEX_CHAR	"Bad character"	R CME
1323	REM_LEX_DEC	"Bad decimal number"	R CME
1324	REM_LEX_EXP	"Exponent magnitude too large"	R CME
1325	REM_LEX_HBLK	"Bad hexadecimal block"	R CME
1326	REM_LEX_HEX	"Bad hexadecimal number"	R CME
1328	REM_LEX_OCT	"Bad octal number"	R CME
1329	REM_LEX_SBUFF	"Too many characters"	R CME
1330	REM_LEX_STR	"Bad string"	R CME
1331	REM_NOOPER	"OPER not allowed while error pending"	R DDE
1500	NRM_COMPLIANCE	"Compliance voltage exceeded"	B S DDE
1501	NRM_SHUNTAMP	"Shunt amp over or underload"	B S DDE
1502	NRM_HEATSINK	"Heat sink too hot"	B S DDE
1503	NRM_SHORT	"Output current lim exceeded"	B S DDE
1505	NRM_VDACCNTS	"VDAC counts out of range"	B S DDE
1506	NRM_IDACCNTS	"IDAC counts out of range"	B S DDE
1507	NRM_ACSDDACCNTS	"AC scale dac counts out of range"	B S DDE
1508	NRM_DCSDDACCNTS	"DC scale dac counts out of range"	B S DDE
1509	NRM_FREQCNTS	"Frequency dac counts out of range"	B S DDE
1510	NRM_IDACOFFSET	"IDAC counts (DC OFFSET) out of range"	B S DDE
1512	NRM_EXTCLK_RD	"Can't read External Clock register"	B S DDE
1513	NRM_EXTCLK_FAST	"External Clock too Fast"	B S DDE

1514	NRM_EXTCLK_SLOW	"External Clock too Slow"	B S DDE
1600	OPM_TRANSITION	"OPM transition error"	B D DDE
1602	OPM_MEASZ	"Z measurement fault"	B D DDE
		to be displayed on front panel, error message must stop here>.	
65535	UNKNOWN	"Unknown error %d"	B DDE

Index

—*—

- *CLS remote command, 6-13
- *ESE remote command, 6-16
- *ESE? remote command, 6-17
- *ESR? remote command, 6-17
- *IDN? remote command, 6-19
- *OPC, 5-47
- *OPC remote command, 6-24
- *OPC?, 5-47
- *OPC? remote command, 6-24
- *OPT? remote command, 6-25
- *PUD remote command, 6-28
- *PUD? remote command, 6-29
- *RST remote command, 6-31
- *SRE remote command, 6-36
- *SRE? remote command, 6-36
- *STB? remote command, 6-37
- *TRG, 6-40
- *TST? remote command, 6-41
- *WAI, 5-47
- *WAI remote command, 6-46

—1—

- 1-channel configuration, 3-8

—5—

- 5820A Operator Manual, 1-7
- 5820A Service Manual, 1-8
- 5-channel option, 3-8

—A—

- AC amplitude verification, 7-7
- AC power input module, 3-10
- AC power input module, location of, 3-10
- AC voltage frequency verification, 7-8

- Accessing the fuse and selecting line voltage, 2-6
- Adjusting output signal, 4-9
- Adjusting values with knob, 4-10
- Air filter, cleaning the, 7-4
- Amplitude calibration, 4-12, 4-14
- AUX INPUT key, 3-7, 3-9, 3-7, 3-9
- Auxiliary input
 - using, 4-35

—B—

- Bus setup procedure, 5-7

—C—

- CAL_ABORT remote command, 6-9
- CAL_BACKUP remote command, 6-9
- CAL_CONST remote command, 6-9
- CAL_DATE? remote command, 6-9
- CAL_FACT remote command, 6-9
- CAL_FACT? remote command, 6-9
- CAL_FAULT? remote command, 6-10
- CAL_INFO remote command, 6-10
- CAL_NEXT remote command, 6-10
- CAL_REF? remote command, 6-10
- CAL_SECT remote command, 6-10
- CAL_SKIP remote command, 6-10
- CAL_START remote command, 6-11
- CAL_STATE? remote command, 6-11
- CAL_STEP? remote command, 6-11
- CAL_STORE? remote command, 6-11, 6-12
- CAL_SW? remote command, 6-12
- Calibrating pulse and frequency response, 4-15
- Calibration switch, 3-9
- Calibration switch, enabled commands, 5-31
- Caution, 2-8, 4-3, 4-6, 7-4, 7-6
- CCP? remote command, 6-12
- CE key, 3-6
- CHAN remote command, 6-12

CHAN? remote command, 6-12, 6-13
 CHANNEL key, 3-7
 Character processing, incoming, 5-35
 CHASSIS GROUND binding post, 3-10
 Checking 5820A status, 5-37
 Cleaning the air filter, 7-4
 Cleaning, general, 7-6
 CLOCK remote command, 6-12, 6-13
 CLS remote command, 6-13
 Command summary by function, 6-3
 Command syntax information, 5-33
 Commands

- alphabetical list, 6-8
- calibration switch enabled, 5-31
- common, 5-28
- compound, 5-30
- coupled, 5-30
- device dependent, 5-28
- IEEE-488 only, 5-32
- overlapped, 5-31
- query, 5-28
- RS-232 only, 5-31
- sequential, 5-31
- summary by function, table of, 6-3
- types of, 5-28
- using, 5-26

 Commands for IEEE-488 only, 5-32
 Commands for RS-232 only, 5-31
 Common commands, 5-28, 6-4
 Compound commands, 5-30
 Control display, 3-5
 Cooling considerations, 2-8
 Coupled commands, 5-30
 Current Output Function, 4-36

—D—

D_SP_SET remote command, 6-13
 D_UUT_SET remote command, 6-13
 DC Voltage Measure

- Measuring the DC Calibration Output of an Oscilloscope, 4-32

 DC voltage verification, 7-6
 DC_OFFSET remote command, 6-14
 DC_OFFSET? remote command, 6-14
 Device-dependent commands, 5-28
 Display

- control, 3-5
- output, 3-4

 Displaying the output error, 4-11
 DIVIDE key, 3-7

—E—

Edge amplitude verification, 7-19
 Edge duty cycle verification, 7-19
 Edge function, 4-15

EDGE key, 3-5
 Edge rise time verification, 7-20
 Edgefrequencyverification, 7-19
 Edit keys, 3-6
 EDIT remote command, 6-14
 EDIT? remote command, 6-15
 Editing settings, 4-8
 EEPROM format menu, 4-6
 ELIST? remote command, 6-15
 ENTER key, 3-8
 ERR? remote command, 6-15
 ERR_UNIT remote command, 6-16
 ERR_UNIT? remote command, 6-16
 Error messages, F-1
 Error mode commands, 6-3
 Error mode, keys that exit, 4-9
 Error output, 4-8
 Error output, displaying the, 4-11
 Error queue, 5-45
 ESE

- bit assignments, 5-40
- programming the, 5-41

 ESE remote command, 6-16
 ESE? remote command, 6-17
 ESR

- bit assignments, 5-40
- explained, 5-40
- programming the, 5-41
- register, 5-40

 ESR? remote command, 6-17
 Event Status

- Enable Register (ESE), 5-40
- Register (ESR), 5-40
- Register bit assignments, 5-40

 EXPLAIN? remote command, 6-17
 Extra space or tab characters, 5-34

—F—

Fan filter, 3-9
 FAULT? remote command, 6-18
 Features

- front panel, 3-4
- rear panel, 3-9

 FORMAT remote command, 6-18
 Frequency response calibration, 4-23
 Frequency sweep, oscilloscope calibration, 4-22
 Front panel features, 3-3
 Front panel operation, 4-3
 FUNC? remote command, 6-19
 Function generator, 4-27
 Fuse, accessing the, 2-6
 Fuse, replacement, 2-4
 Fuse, replacing the, 7-3

—G—

General cleaning, 7-6
 Guidelines for programming the calibrator, 5-45

—I—

IDN remote command, 6-19
 IEEE-488
 bus setup procedure, 5-7
 using for remote control, 5-4
 IEEE-488 connector, D-1
 IEEE-488 interface cable, 9-4
 IEEE-488 interface messages, 5-28
 IEEE-488 interface overview, 5-25
 IEEE-488 port, testing the, 5-8
 IEEE-488 remote control connections, 5-5
 Incoming character processing, 5-35
 INCR remote command, 6-19
 Input buffer operation, 5-48
 Input impedance and capacitance, measuring, 4-32
 Input impedance capacitance verification, 7-21
 Input impedance resistance verification, 7-21
 Inspection, 2-3
 Instruction manuals, 1-7
 Instrument setup, 4-5
 Instrument Status
 Change Enable Register (ISCE), 5-42
 Change Register (ISCR), 5-42
 Instrument Status Register, 5-42
 Interface messages
 Accepted by 5820A - table of, 5-29
 that 5820A sends, 5-30
 Interface messages (IEEE-488), 5-28
 Introduction and specifications (Chapter 1), 1-3
 ISCE
 bit assignments, 5-42
 explained, 5-42
 programming the, 5-44
 ISCE remote command, 6-20
 ISCE? remote command, 6-20
 ISCE0 remote command, 6-20
 ISCE0? remote command, 6-20
 ISCE1 remote command, 6-21
 ISCE1? remote command, 6-21
 ISCR
 bit assignments, 5-42
 explained, 5-42
 programming the, 5-44
 ISCR? remote command, 6-21
 ISCR0? remote command, 6-21
 ISCR1? remote command, 6-21
 ISR
 bit assignments, 5-42
 explained, 5-42
 programming the, 5-44
 ISR? remote command, 6-22

—K—

Keying in values, 4-9
 Keys
 +/-, 3-8
 AUX INPUT, 3-7, 3-9, 3-7, 3-9
 CE, 3-6
 CHANNEL, 3-7
 DIVIDE, 3-7
 EDGE, 3-5
 Edit, 3-6
 ENTER, 3-8
 LEVELED SINE, 3-5
 MARKER, 3-5
 MORE MODES, 3-6
 Multiplier, 3-7
 MULTIPLY, 3-7
 NEW REF, 3-7
 NUMERIC, 3-8
 OPR, 3-5
 RESET, 3-6
 SBY, 3-5
 SETUP, 3-6
 Units, 3-7
 VOLTAGE, 3-5
 KeyS
 PREV MENU, 3-5
 Keys that exit error mode, 4-9
 Knob, adjusting with, 4-10

—L—

LEVELED SINE key, 3-5
 Leveled sinewave flatness verification, 7-13
 Leveled sinewave frequency verification, 7-11
 Leveled sinewave harmonics verification, 7-12
 Leveled sinewave verification, 7-11
 Levsine menu
 frequency sweep, 4-22
 MORE OPTIONS menu, 4-21
 Line power cord types, 2-7
 Line power cord types - table of, 2-7
 Line power, connecting to, 2-5
 Line voltage, selecting, 2-4
 Local operation, 1-5
 LOCAL remote command, 6-22
 Local state, 5-23
 Local with lockout state, 5-23
 LOCKOUT remote command, 6-22
 Lockout state
 local with, 5-23
 remote with, 5-23

—M—

MARKER key, 3-5
 Markergenerator verification, 7-20

MEAS_OFFSET remote command, 6-23
 Measuring input impedance and capacitance, 4-32
 Menu tree, softkeys, 3-10
 Modem cables, 9-4
 MORE MODES key, 3-6
 MORE OPTIONS menu, 4-21
 MULT remote command, 6-23
 MULTIPLY key, 3-7

—N—

NEW REF key, 3-7
 NEWREF remote command, 6-23
 Null-modem cables, 9-4
 NUMERIC keys, 3-8

—O—

OL_TRIP? remote command, 6-24
 OLDREF remote command, 6-23
 ONTIME? remote command, 6-24
 OPC remote command, 6-24
 OPC? remote command, 6-24
 OPER remote command, 6-25
 OPER? remote command, 6-25
 Operate and standby modes, using, 4-7
 Operating state transitions

- local state, 5-23
- local with lockout state, 5-23
- remote state, 5-23
- remote with lockout state, 5-23
- table of, 5-24

 Operation overview, 1-4
 OPR key, 3-5
 OPT? remote command, 6-25
 Options and accessories, 9-3
 Options and accessories, table of, 9-3
 Oscilloscope calibration

- adjusting output signal, 4-8
- amplitude, 4-12, 4-14
- edge function, 4-15
- frequency response, 4-23
- frequency sweep, 4-22
- measuring input impedance and capacitance, 4-32
- MORE OPTIONS menu, 4-21
- oscilloscope connection, 4-7
- pulse response, 4-15, 4-17, 4-18
- resetting parameters, 4-11
- starting, 4-8
- testing the trigger, 4-27
- time base, 4-24
- time marker, 4-25
- time marker, 4-26
- trigger connection, 4-7
- trigger menu, 4-14, 4-16, 4-26
- V/DIV menu, 4-13

volt function, 4-12
 voltage gain, 4-12, 4-14
 wave generator, 4-27
 Oscilloscope connection

- external trigger, 4-7

 Oscilloscope Connection

- Channel and External Trigger, 4-7

 Oscilloscope connections, 4-7
 OUT remote command, 6-25
 OUT? remote command, 6-27
 OUT_ERR? remote command, 6-27
 OUT_IMP remote command, 6-27
 OUT_IMP? remote command, 6-28
 Output commands, 6-5
 Output display, 3-4
 Output queue, 5-44
 Output signal

- adjusting, 4-9
- adjusting for oscilloscope calibration, 4-8

 Overlapped commands, 5-31
 Overload protection, testing, 4-34

—P—

Parameter syntax rules, 5-33
 Placement of calibrator, 2-7
 Power cords, 2-7
 Preparing for operation (Chapter 2), 2-3
 PREV MENU key, 3-5
 Program examples

- remote, 5-45
- using *OPC?, *OPC, and *WAI, 5-47
- writing an error handler, 5-46
- writing an SRQ handler, 5-46

 Program Examples

- Taking an impedance measurement, 5-47

 Programming

- The ESR and ESE, 5-41
- the STB and SRE, 5-40

 Programming the calibrator, 5-45
 PUD remote command, 6-28
 PUD? remote command, 6-29
 Pulse capture, verifying, 4-30
 Pulse generator period verification, 7-21
 Pulse generator pulse width verification, 7-21
 Pulse response calibration, 4-15, 4-17, 4-18

—Q—

Query commands, 5-28
 Queue, output, 5-44

—R—

Rack mount kit, 9-3
 Rack mounting, 2-7
 RANGE remote command, 6-29

- RANGE? remote command, 6-29
RANGELCK remote command, 6-30
RANGELCK? remote command, 6-30
Rear panel features, 3-3
REFOUT? remote command, 6-31
Registers
 event status (ESR), 5-40
 Event Status Enable (ESE), 5-40
 Instrument Status (ISR), 5-42
 Instrument Status Change (ISCR), 5-42
 Instrument Status Change Enable (ISCE), 5-42
REMOTE command, 6-31
Remote control
 using host port, 5-11, 5-16
 using IEEE port, 5-4
Remote operation, 1-5
Remote operation (Chapter 5), 5-4
Remote operation (IEEE-488), 1-6
Remote program examples, 5-45
Remote state, 5-23
Remote with lockout state, 5-23
Replacing the line fuse, 7-3
RESET key, 3-6
Resetting the calibrator, 4-7
Response data types
 binary block data, 5-36
 floating, 5-36
 indefinite ASCII, 5-36
 integer, 5-36
 string, 5-36
 table of, 5-36
Response message syntax, 5-36
RS-232
 controlling an instrument, 5-48
 host port setup procedure, 5-11
 using host port, 5-11, 5-16
 UUT port setup procedure, 5-16
RS-232 Host Port commands, 6-6
RS-232 host port operation using a terminal, 5-13
RS-232 host port operation using Visual Basic, 5-15
RS-232 Host port setup procedure, 5-11
RS-232 host port, testing the, 5-13
RS-232 interface overview, 5-24
RS-232 modem cables, 9-4
RS-232 null-modem cables, 9-4
RS-232 remote control connections, 5-6
RS-232 UUT Port commands, 6-7
RS-232 UUT port operation using Visual Basic, 5-20
RS-232 UUT port operation via a terminal, 5-19
RS-232 UUT port setup procedure, 5-16
RS-232 UUT port testing via IEEE-488 port, 5-21
RS-232 UUT port testing via RS-232 host port, 5-17
RS-232 remote command, 6-31
- S—**
- SBY key, 3-5
SCOPE remote command, 6-32
SCOPE? remote command, 6-34
Sequential commands, 5-31
Serial connector, D-2
Serial poll, status byte, 5-37
Service information, 2-7
Service request
 SRQ line, 5-39
Service Request
 Enable Register (SRE), 5-39
Setting frequency and voltage, shortcuts, 4-21
Setting up the RS-232 host port for remote control, 5-11
Setting up the RS-232 UUT port for remote control, 5-16
Setting voltage amplitude, shortcuts, 4-13
Setup and utility commands, 6-6
SETUP key, 3-6
Setup menu, 4-4
Setup menus
 format EEPROM menu, 4-6
 IEEE-488 port, 5-7
 instrument setup, 4-5
 RS-232 host port, 5-11
 utility functions menu, 4-5
SETUP softkey menu tree, 3-10
Setup softkey menu trees, 3-10
Signal, adjusting during oscilloscope calibration, 4-8
Softkeys, using, 4-4
SP_SET, 6-34
SP_SET? remote command, 6-35
Specifications, 1-8
SPLSTR remote command, 6-35
SPLSTR? remote command, 6-36
SRE
 programming the, 5-40
 register, 5-39
SRE remote command, 6-36
SRE? remote command, 6-36
SRQ, service request line, 5-39
SRQSTR remote command, 6-37
SRQSTR? remote command, 6-37
Standard equipment table, 2-3
Starting oscilloscope calibration, 4-8
Status
 checking 5820A, 5-37
 register overview - figure, 5-38
 register summary - table, 5-37
 serial poll status byte, 5-37
Status commands, 6-7
STB
 explained, 5-37

- programming the, 5-40
- STB remote command, 6-37
- STBY remote command, 6-38
- Summary of commands and queries, 6-8
- Syntax
 - information, general, 5-33
 - parameter rules, 5-33
 - response messages, 5-36

—T—

- Tab characters, 5-34
- Taking an impedance measurement, 5-47
- TDPULSE remote command, 6-38
- TDPULSE? remote command, 6-38
- Terminators, 5-35
- Testing overload protection, 4-34
- Testing RS-232 host port operation using a terminal, 5-13
- Testing RS-232 host port operation using Visual Basic, 5-15
- Testing RS-232 UUT port operation using Visual Basic, 5-20
- Testing RS-232 UUT port operation via a terminal, 5-19
- Testing the IEEE-488 port, 5-8
- Testing the RS-232 host port, 5-13
- Testing the RS-232 UUT port via IEEE-488 port, 5-21
- Testing the RS-232 UUT port via RS-232 host port, 5-17
- Testing video triggers, 4-29
- Time base calibration, 4-24
- Time marker function
 - specifications, 8-6
- Time marker, oscilloscope calibration, 4-25, 4-26
- TLIMIT remote command, 6-38
- TLIMIT? remote command, 6-38
- TLIMIT_D remote command, 6-39
- TLIMIT_D? remote command, 6-39
- TMWAVE remote command, 6-39
- TMWAVE? remote command, 6-39
- TRIG remote command, 6-40
- TRIG? remote command, 6-40
- TRIG_CHAN remote command, 6-41
- TRIG_CHAN? remote command, 6-41
- Trigger menu, 4-14, 4-16, 4-26, 4-31
- Trigger menu, oscilloscope calibration, 4-14, 4-16, 4-26
- Trigger menu, verifying pulse capture, 4-31
- Trigger tests for oscilloscope, 4-27
- Tunnel diode pulser verification, 7-20
- Turning on the calibrator, 4-3
- Types of commands, 5-28

—U—

- Unpacking, 2-3
- Using auxiliary input, 4-35
- Using commands, 5-26
- Using operate and standby modes, 4-7
- Using the format EEPROM menu, 4-6
- Using the instrument setup menu, 4-5
- Using the setup menu, 4-4
- Using the softkeys, 4-4
- Utility functions menu, 4-5
- UUT Port
 - controlling an instrument, 5-48
- UUT_FLUSH remote command, 6-42
- UUT_RECV? remote command, 6-42
- UUT_SEND remote command, 6-43
- UUT_SET remote command, 6-44
- UUT_SET? remote command, 6-44

—V—

- V/DIV menu, 4-13
- VAL? remote command, 6-45
- Values, keying in, 4-9
- Verification
 - AC amplitude, 7-7
 - AC voltage frequency, 7-8
 - DC voltage, 7-6
 - edge, amplitude, 7-19
 - edge, duty cycle, 7-19
 - edge, frequency, 7-19
 - edge, rise time, 7-20
 - input impedance, capacitance, 7-21
 - input impedance, resistance, 7-21
 - leveled sinewave, 7-11
 - leveled sinewave, flatness, 7-13
 - leveled sinewave, frequency, 7-11
 - leveled sinewave, harmonics, 7-12
 - marker generator, 7-20
 - pulse generator, period, 7-21
 - pulse generator, pulse width, 7-21
 - tunnel diode pulser, 7-20
 - wave generator amplitude, 1 M Ω , 7-9
 - wave generator amplitude, 50 Ω , 7-10
 - wave generator frequency, 1 M Ω , 7-11
- Verifying pulse capture, 4-30
 - trigger menu, 4-31
- Video triggers, testing, 4-29
- VIDEOFMT remote command, 6-45
- VIDEOFMT? remote command, 6-45
- VIDEOMARK remote command, 6-45
- VIDEOMARK? remote command, 6-46
- Visual Basic test program, creating, E-1
- Volt function, 4-12
 - V/DIV menu, 4-13
- Voltage gain calibration, 4-12, 4-14

VOLTAGE key, 3-5
Voltage, selecting line, 2-4

—W—

WAI remote command, 6-46
Warming the calibrator, 4-4
Wave generator, 4-27
Wave generator amplitude verification, 1 M Ω , 7-9
Wave generator amplitude verification, 50 Ω , 7-10
Wave generator frequency verification, 1 M Ω , 7-11
WAVE remote command, 6-46

WAVE? remote command, 6-46
Wavegen menu, 4-27
Where to go from here, 1-7

—Z—

ZERO_MEAS remote command, 6-46
Ziatech ZT-1444A
 DIP switch positions, C-1
 jumper positions, C-1

